

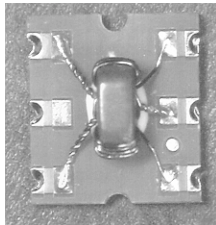

# E-Series 2-Way 0° Power Divider 5 - 1000 MHz

## Features

- 2 Way
- 0 Degree
- Surface Mount



## Description

M/A-COM's ESSM-2-8-75 is a 2 Way 0° Power Divider in a low cost, surface mount package. Ideally suited for high volume cellular, wireless and CATV applications. An external 160 Ohm chip resistor is required with this part.

## SM-55 Package

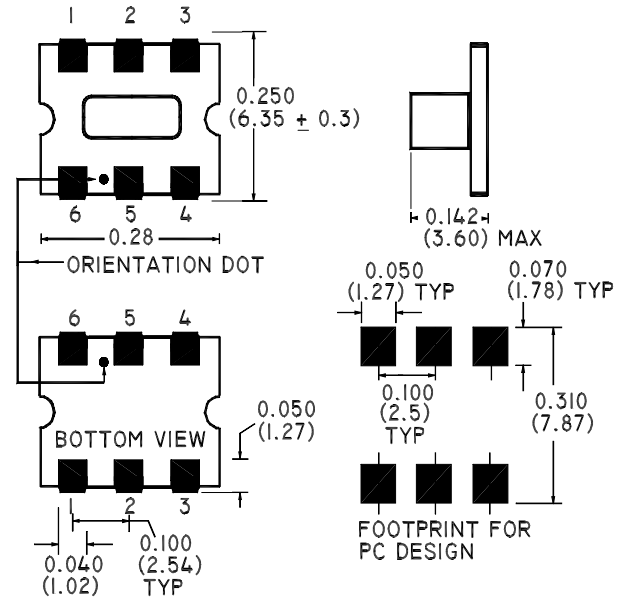

## Electrical Specifications @25°C

Parameter	Units	Typical	Minimum	Maximum
Frequency Range	5 - 1000	—	—	—
Insertion Loss	5 - 40 MHz	0.6	—	1.0
	40 - 400 MHz	0.6	—	0.9
	400 - 500 MHz	0.8	—	1.0
	500 - 1000 MHz	0.8	—	1.4
Isolation	5 - 40 MHz	26	19	—
	40 - 400 MHz	26	19	—
	400 - 500 MHz	21	16	—
	500 - 1000 MHz	17	10	—
Amplitude Unbalance	5 - 40 MHz	—	—	0.6
	40 - 400 MHz	—	—	0.4
	400 - 500 MHz	—	—	0.6
	500 - 1000 MHz	—	—	0.6
Phase Unbalance	5 - 40 MHz	—	—	3.0°
	40 - 400 MHz	—	—	3.0°
	400 - 500 MHz	—	—	3.0°
	500 - 1000 MHz	—	—	5.0°
Output Return Loss	5 - 40 MHz	20	14	—
	40-870 MHz	24	18	—
	40 - 1000 MHz	24	18	—
Input Return Loss	5 - 40 MHz	20	20	—
	40-870 MHz	22	17	—
	40 - 1000 MHz	22	16	—

Please Note that the photograph above indicates package shape only, unit may be wired differently.

Specifications subject to change without notice.

S 1206 D V 4.0

- North America: Tel. (800) 366-2266, Fax (800) 618-8883
- Asia/Pacific: Tel.+81-44-844-8296, Fax +81-44-844-8298
- Europe: Tel. +44 (1344) 869 595, Fax+44 (1344) 300 020



Visit [www.macom.com](http://www.macom.com) for additional data sheets and product information.

**Absolute Maximum Ratings**

Parameter	Absolute Maximum
RF Power	1 Watt
Internal Load Dissipation	0.125 Watt
Pin Temp (10 Sec)	260°C
Storage Temperature	-20°C to 85°C
Operating Temperature	-20°C to 85°C

**Functional Configuration**

Function	Pin No.
Not Connected	5,2
External 75 Ohms	—
Ground	1
Case Ground	—
Input	6
Port 1	4
Port 2	3

**Typical Performance @ +25°C**

**Insertion Loss**

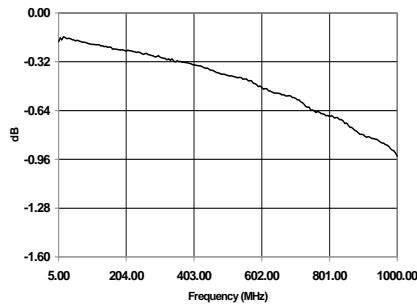

**Isolation**

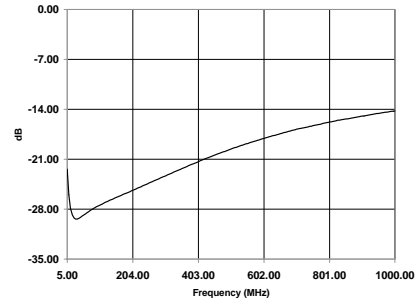

**Amplitude Unbalance**

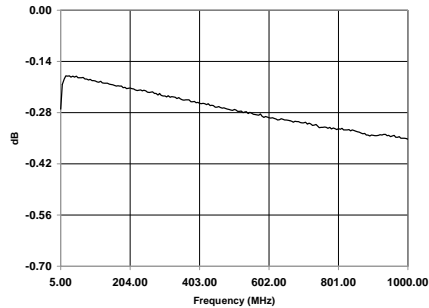

**Phase Unbalance**

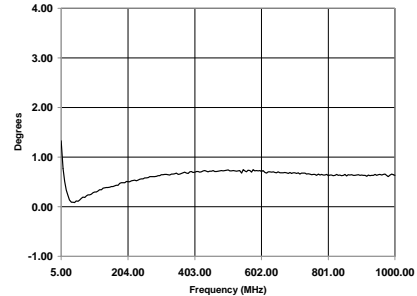

**Output Return Loss**

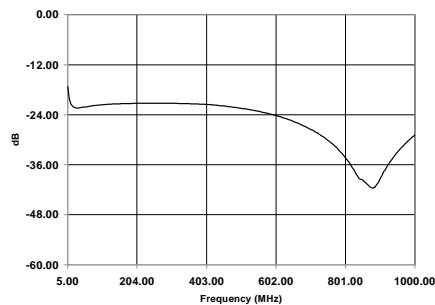

**Input Return Loss**

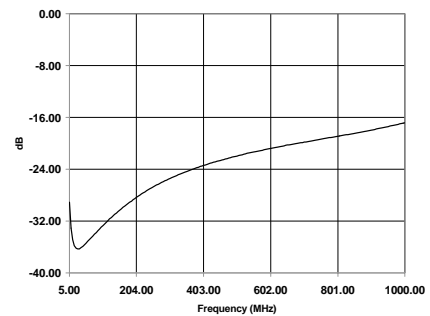

Specifications subject to change without notice.

S 1206 D V 4.0

■ North America: Tel. (800) 366-2266, Fax (800) 618-8883  
 ■ Asia/Pacific: Tel.+81-44-844-8296, Fax +81-44-844-8298  
 ■ Europe: Tel. +44 (1344) 869 595, Fax+44 (1344) 300 020

Visit [www.macom.com](http://www.macom.com) for additional data sheets and product information.

