

0.50mm (0.02") PITCH CONNECTOR

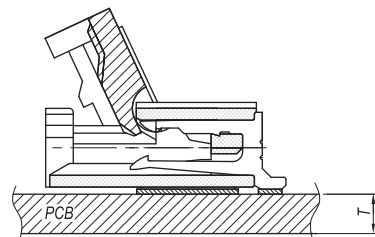

FPC/FFC Connector Housing

05002HR-00A01 Series
SMT, ZIF(Bottom Contact Type)
Right Angle

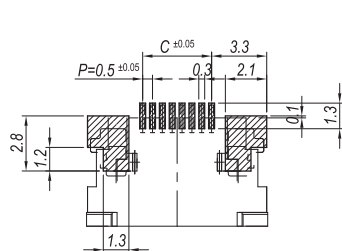
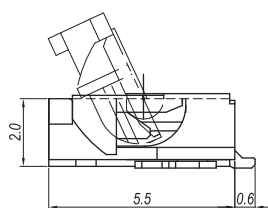
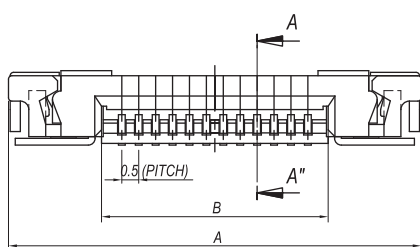
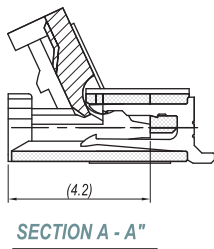
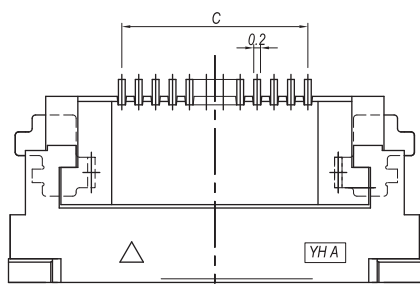
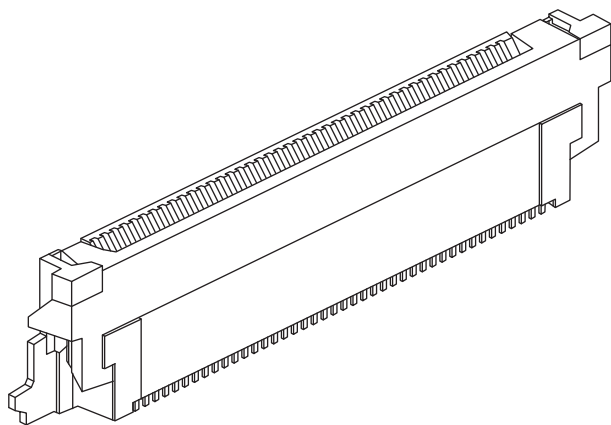

PCB LAYOUT (05002HR-00A01)

PCB ASS'Y (05002HR-00A01)

Material

I/NO	DESCRIPTION	TITLE	MATERIAL
1	HOUSING	05002HR	PA46 or LCP or PA6T, UL 94V Grade
2	ACTUATOR	05002AS	PPS, UL 94V Grade
3	TERMINAL	05002TR	Phosphor Bronze & Tin plated
4	HOOK	05002LR	Phosphor Bronze & Tin plated

Available Pin

PARTS NO.	A	B	C
05002HR-10A01	11.2	5.5	4.50
05002HR-11A01	11.7	6.0	5.00
05002HR-12A01	12.2	6.5	5.50
05002HR-13A01	12.7	7.0	6.00
05002HR-14A01	13.2	7.50	6.50
05002HR-15A01	13.7	8.00	7.00
05002HR-16A01	14.2	8.5	7.50
05002HR-17A01	14.7	9.00	8.00
05002HR-18A01	15.2	9.50	8.50
05002HR-19A01	15.7	10.0	9.00
05002HR-20A01	16.2	10.5	9.50
05002HR-21A01	16.7	11.0	10.0
05002HR-22A01	17.2	11.5	10.5
05002HR-23A01	17.7	12.0	11.0
05002HR-24A01	18.2	12.5	11.5
05002HR-25A01	18.7	13.0	12.0
05002HR-26A01	19.2	13.5	12.5
05002HR-27A01	19.7	14.0	13.0
05002HR-28A01	20.2	14.5	13.5
05002HR-29A01	20.7	15.0	14.0
05002HR-30A01	21.2	15.5	14.5
05002HR-31A01	21.7	16.0	15.0
05002HR-32A01	22.2	16.5	15.5
05002HR-33A01	22.7	17.0	16.0
05002HR-34A01	23.2	17.5	16.5
05002HR-35A01	23.7	18.0	17.0
05002HR-36A01	24.2	18.5	17.5
05002HR-37A01	24.7	19.0	18.0
05002HR-38A01	25.2	19.5	18.5
05002HR-39A01	25.7	20.0	19.0
05002HR-40A01	26.2	20.5	19.5
05002HR-41A01	26.7	21.0	20.0
05002HR-42A01	27.2	21.5	20.5
05002HR-43A01	27.7	22.0	21.0
05002HR-44A01	28.2	22.5	21.5
05002HR-45A01	28.7	23.0	22.0
05002HR-46A01	29.2	23.5	22.5
05002HR-47A01	29.7	24.0	23.0
05002HR-48A01	30.2	24.5	23.5
05002HR-49A01	30.7	25.0	24.0
05002HR-50A01	31.2	25.5	24.5

Specification

ITEM	SPEC
Voltage Rating	AC/DC 50V
Current Rating	AC/DC 0.5A
Operating Temperature	-25°C ~ +85°C
Contact Resistance	30mΩ MAX
Withstanding Voltage	AC500V/1min
Insulation Resistance	100MΩ MIN
Applicable Wire	-
Applicable P.C.B	0.8 ~ 1.6mm
Applicable FPC/FFC	0.30±0.05mm
Solder Height	0.15mm
Crimp Tensile Strength	-
UL FILE NO	-