

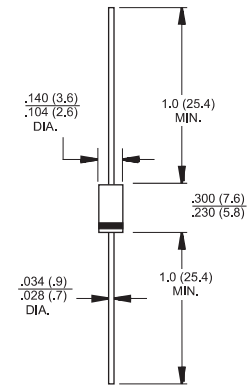

DO-15

Features

- ✧ Plastic package has Underwriters Laboratory Flammability Classification 94V-0
- ✧ 600W surge capability at 10 x 1000 us waveform
- ✧ Excellent clamping capability
- ✧ Low Dynamic impedance
- ✧ Fast response time: Typically less than 1.0ps from 0 volts to VBR for unidirectional and 5.0 ns for bidirectional
- ✧ Typical I_R less than 1uA above 10V
- ✧ High temperature soldering guaranteed: 260°C / 10 seconds / .375", (9.5mm) lead length / 5lbs., (2.3kg) tension



Mechanical Data

Dimensions in inches and (millimeters)

- ✧ Case: Molded plastic
- ✧ Polarity: Color band denotes cathode except bipolar
- ✧ Weight: 0.42gram

Maximum Ratings and Electrical Characteristics

Rating at 25 °C ambient temperature unless otherwise specified.

Single phase, half wave, 60 Hz, resistive or inductive load.

For capacitive load, derate current by 20%

Type Number	Symbol	Value	Units
Peak Power Dissipation at $T_A=25^{\circ}\text{C}$, $T_p=1\text{ms}$ (Note 1)	P_{PK}	Minimum 600	Watts
Steady State Power Dissipation at $T_L=75^{\circ}\text{C}$ Lead Lengths .375", 9.5mm (Note 2)	P_D	5.0	Watts
Peak Forward Surge Current, 8.3 ms Single Half Sine-wave Superimposed on Rated Load (JEDEC method) (Note 3)	I_{FSM}	100	Amps
Maximum Instantaneous Forward Voltage at 50.0A for Unidirectional Only (Note 4)	V_F	3.5 / 5.0	Volts
Typical Thermal Resistance (Note 5)	$R_{\theta JL}$ $R_{\theta JA}$	10 62	$^{\circ}\text{C/W}$
Operating and Storage Temperature Range	T_J, T_{STG}	-55 to + 175	$^{\circ}\text{C}$

- Notes:
1. Non-repetitive Current Pulse Per Fig. 3 and Derated above $T_A=25^{\circ}\text{C}$ Per Fig. 2.
 2. Mounted on Copper Pad Area of 0.4 x 0.4" (10 x 10 mm) Per Fig. 4.
 3. 8.3ms Single Half Sine-wave or Equivalent Square Wave, Duty Cycle=4 Pulses Per Minutes Maximum.
 4. $V_F=3.5\text{V}$ for Devices of $V_{BR} \leq 200\text{V}$ and $V_F=5.0\text{V}$ Max. for Devices of $V_{BR}>200\text{V}$.
 5. Measured on P.C.B. with 10mm x 10mm.

Devices for Bipolar Applications

1. For Bidirectional Use C or CA Suffix for Types P6KE6.8 through Types P6KE440.
2. Electrical Characteristics Apply in Both Directions.

RATINGS AND CHARACTERISTIC CURVES (P6KE SERIES)

FIG.1- PEAK PULSE POWER RATING CURVE

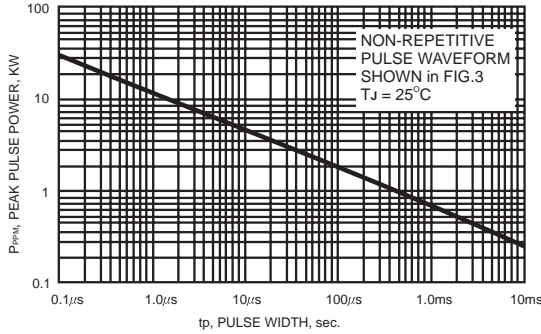

FIG.2- PULSE DERATING CURVE

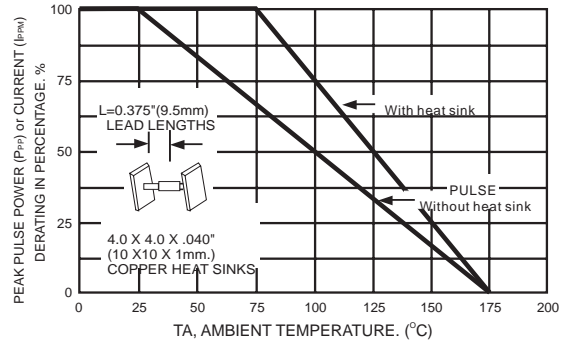

FIG.3- CLAMPING POWER PULSE WAVEFORM

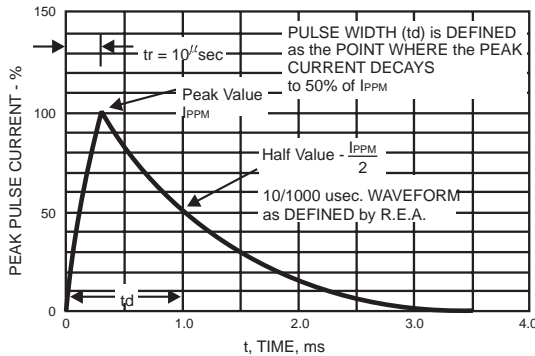

FIG.4- MAXIMUM NON-REPETITIVE FORWARD SURGE CURRENT UNIDIRECTIONAL ONLY

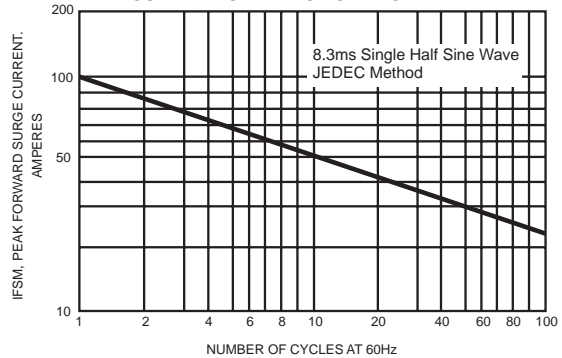
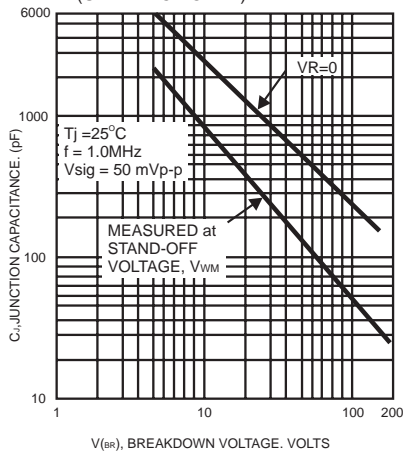

FIG.5- TYPICAL JUNCTION CAPACITANCE (UNIDIRECTIONAL)





P6KE SERIES

600 Watts Transient Voltage Suppressor Diodes



ELECTRICAL CHARACTERISTICS (at TA=25 °C unless otherwise noted)

TYPE	BREAKDOWN VOLTAGE		TEST CURRENT	REVERSE STAND-OFF VOLTAGE	REVERSE LEAKAGE	PULSE CURRENT	MAXIMUM CLAMPING VOLTAGE	MAXIMUM TEMPERATURE COEFFICIENT OF V _(BR)
	V _(BR) (Note 1)							
	V(MIN)	V(MAX)	I _r mA	V _{WM} V	I ₀ @V _{WM} (Note 2) µA	I _{ppm} A	V _c @ I _{ppm} V	
P6KE6.8	6.12	7.48	10.0	5.50	1000.0	58.0	10.8	0.057
P6KE6.8A	6.45	7.14	10.0	5.80	1000.0	60.0	10.5	0.057
P6KE7.5	6.75	8.25	10.0	6.05	500.0	53.0	11.7	0.061
P6KE7.5A	7.13	7.88	10.0	6.40	500.0	55.0	11.3	0.061
P6KE8.2	7.38	9.02	10.0	6.63	200.0	50.0	12.5	0.065
P6KE8.2A	7.79	8.61	10.0	7.02	200.0	52.0	12.1	0.065
P6KE9.1	8.19	10.0	1.0	7.37	50.0	45.0	13.8	0.068
P6KE9.1A	8.65	9.55	1.0	7.78	50.0	47.0	13.4	0.068
P6KE10	9.00	11.0	1.0	8.10	10.0	42.0	15.0	0.073
P6KE10A	9.50	10.5	1.0	8.55	10.0	43.0	14.5	0.073
P6KE11	9.90	12.1	1.0	8.92	5.0	38.0	16.2	0.075
P6KE11A	10.5	11.6	1.0	9.40	5.0	40.0	15.6	0.075
P6KE12	10.8	13.2	1.0	9.72	5.0	36.0	17.3	0.078
P6KE12A	11.4	12.6	1.0	10.2	5.0	37.0	16.7	0.078
P6KE13	11.7	14.3	1.0	10.5	5.0	33.0	19.0	0.081
P6KE13A	12.4	13.7	1.0	11.1	5.0	34.0	18.2	0.081
P6KE15	13.5	16.5	1.0	12.1	5.0	28.0	22.0	0.084
P6KE15A	14.3	15.8	1.0	12.8	5.0	29.0	21.2	0.084
P6KE16	14.4	17.6	1.0	12.9	5.0	26.0	23.5	0.086
P6KE16A	15.2	16.8	1.0	13.6	5.0	28.0	22.5	0.086
P6KE18	16.2	19.8	1.0	14.5	5.0	23.0	26.5	0.088
P6KE18A	17.1	18.9	1.0	15.3	5.0	25.0	25.2	0.088
P6KE20	18.0	22.0	1.0	16.2	5.0	21.0	29.1	0.090
P6KE20A	19.0	21.0	1.0	17.1	5.0	22.0	27.7	0.090
P6KE22	19.8	24.2	1.0	17.8	5.0	19.0	31.9	0.092
P6KE22A	20.9	23.1	1.0	18.8	5.0	20.0	30.6	0.092
P6KE24	21.6	26.4	1.0	19.4	5.0	18.0	34.7	0.094
P6KE24A	22.8	25.2	1.0	20.5	5.0	19.0	33.2	0.094
P6KE27	24.3	29.7	1.0	21.8	5.0	16.0	39.1	0.096
P6KE27A	25.7	28.4	1.0	23.1	5.0	16.8	37.5	0.096
P6KE30	27.0	33.0	1.0	24.3	5.0	14.0	43.5	0.097
P6KE30A	28.5	31.5	1.0	25.6	5.0	15.0	41.4	0.097
P6KE33	29.7	36.3	1.0	26.8	5.0	13.0	47.7	0.098
P6KE33A	31.4	34.7	1.0	28.2	5.0	13.8	45.7	0.098
P6KE36	32.4	39.6	1.0	29.1	5.0	12.0	52.0	0.099
P6KE36A	34.2	37.8	1.0	30.8	5.0	12.6	49.9	0.099
P6KE39	35.1	42.9	1.0	31.6	5.0	11.1	56.4	0.100
P6KE39A	37.1	41.0	1.0	33.3	5.0	11.6	53.9	0.100
P6KE43	38.7	47.3	1.0	34.8	5.0	10.0	61.9	0.101
P6KE43A	40.9	45.2	1.0	36.8	5.0	10.6	59.3	0.101
P6KE47	42.3	51.7	1.0	38.1	5.0	9.2	67.8	0.101
P6KE47A	44.7	49.4	1.0	40.2	5.0	9.7	64.8	0.101
P6KE51	45.9	56.1	1.0	41.3	5.0	8.5	73.5	0.102
P6KE51A	48.5	53.6	1.0	43.6	5.0	8.9	70.1	0.102
P6KE56	50.4	61.6	1.0	45.4	5.0	7.8	80.5	0.103
P6KE56A	53.2	58.8	1.0	47.8	5.0	8.1	77.0	0.103
P6KE62	55.8	68.2	1.0	50.2	5.0	7.0	89.0	0.104
P6KE62A	58.9	65.1	1.0	53.0	5.0	7.4	85.0	0.104
P6KE68	61.2	74.8	1.0	55.1	5.0	6.4	98.0	0.104
P6KE68A	64.6	71.4	1.0	58.1	5.0	6.8	92.0	0.104



P6KE SERIES

600 Watts Transient Voltage Suppressor Diodes



ELECTRICAL CHARACTERISTICS (at TA=25 °C unless otherwise noted)

TYPE	BREAKDOWN VOLTAGE		TEST CURRENT	REVERSE STAND-OFF VOLTAGE	REVERSE LEAKAGE	PULSE CURRENT	MAXIMUM CLAMPING VOLTAGE	MAXIMUM TEMPERATURE COEFFICIENT OF V _(BR)
	V _(BR) (Note 1)		I _T	V _{WM}	I ₀ @V _{WM} (Note 2)	I _{ppm}	V _C @ I _{ppm}	
	V(MIN)	V(MAX)	mA	V	μA	A	V	
P6KE75	67.5	82.5	1.0	60.7	5.0	5.8	108	0.105
P6KE75A	71.3	78.8	1.0	64.1	5.0	6.1	103	0.105
P6KE82	73.8	90.2	1.0	66.4	5.0	5.3	118	0.105
P6KE82A	77.9	86.1	1.0	70.1	5.0	5.5	113	0.105
P6KE91	81.9	100	1.0	73.7	5.0	4.8	131	0.106
P6KE91A	86.5	95.5	1.0	77.8	5.0	5.0	125	0.106
P6KE100	90.0	110	1.0	81.0	5.0	4.3	144	0.106
P6KE100A	95.0	105	1.0	85.5	5.0	4.5	137	0.106
P6KE110	99.0	121	1.0	89.2	5.0	3.9	158	0.107
P6KE110A	105	116	1.0	94.0	5.0	4.1	152	0.107
P6KE120	108	132	1.0	97.2	5.0	3.6	173	0.107
P6KE120A	114	126	1.0	102	5.0	3.8	165	0.107
P6KE130	117	143	1.0	105	5.0	3.3	187	0.107
P6KE130A	124	137	1.0	111	5.0	3.5	179	0.107
P6KE150	135	165	1.0	121	5.0	2.9	215	0.108
P6KE150A	143	158	1.0	128	5.0	3.0	207	0.108
P6KE160	144	176	1.0	130	5.0	2.7	230	0.108
P6KE160A	152	168	1.0	136	5.0	2.8	219	0.108
P6KE170	153	187	1.0	138	5.0	2.5	244	0.108
P6KE170A	162	179	1.0	145	5.0	2.6	234	0.108
P6KE180	162	198	1.0	146	5.0	2.4	258	0.108
P6KE180A	171	189	1.0	154	5.0	2.5	246	0.108
P6KE200	180	220	1.0	162	5.0	2.1	287	0.108
P6KE200A	190	210	1.0	171	5.0	2.2	274	0.108
P6KE220	198	242	1.0	175	5.0	1.8	344	0.108
P6KE220A	209	231	1.0	185	5.0	1.9	328	0.108
P6KE250	225	275	1.0	202	5.0	1.7	360	0.110
P6KE250A	237	263	1.0	214	5.0	1.8	344	0.110
P6KE300	270	330	1.0	243	5.0	1.4	430	0.110
P6KE300A	285	315	1.0	256	5.0	1.5	414	0.110
P6KE350	315	385	1.0	284	5.0	1.2	504	0.110
P6KE350A	332	368	1.0	300	5.0	1.3	482	0.110
P6KE400	360	440	1.0	324	5.0	1.9	574	0.110
P6KE400A	380	420	1.0	342	5.0	1.10	548	0.110
P6KE440	396	484	1.0	356	5.0	0.95	631	0.110
P6KE440A	418	462	1.0	376	5.0	1.00	602	0.110
P4KE480	432	528	1.0	389	5.0	0.88	686	0.110
P4KE480A	456	504	1.0	408	5.0	0.91	658	0.110
P6KE500	450	550	1.0	400	5.0	0.86	698	0.110
P6KE500A	475	525	1.0	428	5.0	0.90	667	0.110
P6KE510	459	561	1.0	413	5.0	0.82	729	0.110
P6KE510A	485	535	1.0	434	5.0	0.86	698	0.110
P6KE540	486	594	1.0	437	5.0	0.78	772	0.110
P6KE540A	513	567	1.0	459	5.0	0.81	740	0.110
P6KE550	495	605	1.0	440	5.0	0.74	811	0.110
P6KE550A	523	578	1.0	470	5.0	0.77	779	0.110
P6KE600	540	660	1.0	480	5.0	0.69	870	0.120
P6KE600A	570	630	1.0	513	5.0	0.71	850	0.120

- Notes): 1. V_(BR) measured after IT applied for 300 μs, IT = square pulse or equivalent
 2. For bidirectional types having VRWM of 10 volts and less, the ID limit is doubled.
 3. For bidirectional use C or CA suffix for types P6KE6.8 thru type P6KE600, Electrical characteristics apply in both directions.

TVS APPLICATION NOTES:

Transient Voltage Suppressors may be used at various points in a circuit to provide various degrees of protection. The following is a typical linear power supply with transient voltage suppressor units placed at different points. All provide protection of the load.

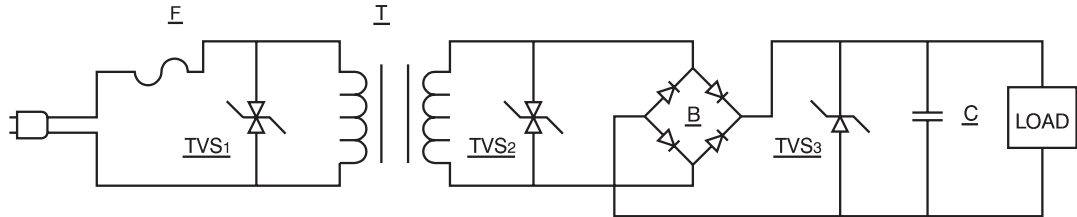

FIGURE 1

Transient Voltage Suppressors 1 provides maximum protection. However, the system will probably require replacement of the line fuse(F) since it provides a dominant portion of the series impedance when a surge is encountered.

However, we do not recommend to use the TVS diode here, unless we can know the electric circuit impedance and the magnitude of surge rushed into the circuit. Otherwise the TVS diode is easy to be destroyed by voltage surge.

Transient Voltage Suppressor 2 provides excellent protection of circuitry excluding the transformer(T). However, since the transformer is a large part of the series impedance, the chance of the line fuse opening during the surge condition is reduced.

Transient Voltage Suppressor 3 provides the load with complete protection. It uses a unidirectional Transient Voltage Suppressor, which is a cost advantage. The series impedance now includes the line fuse, transformer, and bridge rectifier(B) so failure of the line fuse is further reduced. If only Transient Voltage Suppressor 3 is in use, then the bridge rectifier is unprotected and would require a higher voltage and current rating to prevent failure by transients.

Any combination of these three, or any one of these applications, will prevent damage to the load. This would require varying trade-offs in power supply protection versus maintenance(changing the time fuse).

An additional method is to utilize the Transient Voltage Suppressor units as a controlled avalanche bridge. This reduces the parts count and incorporates the protection within the bridge rectifier.

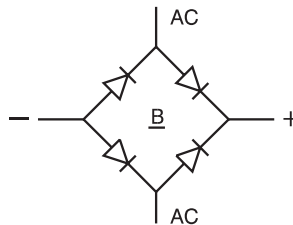

PACKAGE	SPQ/PCS	CARTON SPQ/PCS	CARTON SIZE/CM	CARTON GW/KG	CARTON NW/KG
DO-15	3000/AMMO	30000	42X28X31	12.00	10.00