

3 W Power Amplifier 12.7 - 13.3 GHz

Rev. V1

Features

- 23 dB Small Signal Gain
- 42 dBm Third Order Intercept Point (OIP3)
- >2.5 W Output P1dB
- Integrated Power Detector
- Bias 1200 mA @ 6 V
- Lead-Free 5 mm 24-lead QFN Package
- RoHS* Compliant and 260°C Reflow Compatible

Description

The MAAP-010516 is a packaged linear power amplifier that operates from 12.7 - 13.3 GHz. The device provides 23 dB gain and 42 dBm Output Third Order Intercept Point (OIP3) with 34 dBm output P1dB.

The packaged amplifier comes in an industry standard, fully molded 5 mm QFN package and is comprised of a three stage power amplifier with an integrated, temperature compensated on-chip power detector. The device includes on-chip ESD protection structures and DC by-pass capacitors to ease the implementation and volume assembly of the packaged part.

The device is specifically designed for use in 13 GHz point-to-point radios for cellular backhaul applications.

Ordering Information¹

Part Number	Package
MAAP-010516-000000	bulk quantity
MAAP-010516-TR0500	500 piece reel
MAAP-010516-001SMB	evaluation module

1. Reference Application Note M513 for reel size information.

Functional Schematic

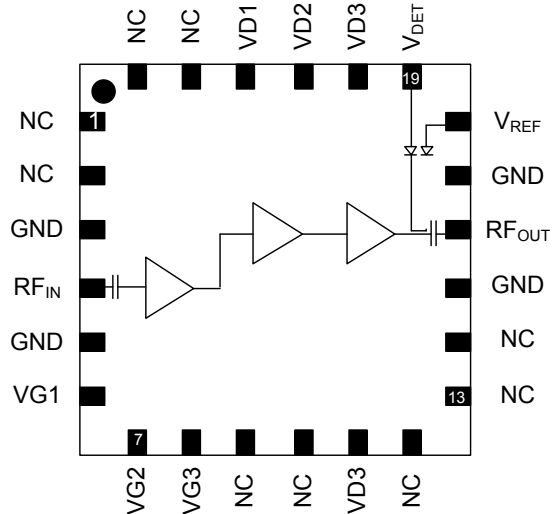

Pin Configuration²

Pin No.	Function	Pin No.	Function
1	No Connection	13	No Connection
2	No Connection	14	No Connection
3	Ground	15	Ground
4	RF Input	16	RF Output
5	Ground	17	Ground
6	Gate 1 Bias	18	Pwr Det Ref
7	Gate 2 Bias	19	Pwr Det
8	Gate 3 Bias	20 ²	Drain 3 Bias
9	No Connection	21	Drain 2 Bias
10	No Connection	22	Drain 1 Bias
11 ²	Drain 3 Bias	23	No Connection
12	No Connection	24	No Connection
		25 ³	Paddle

2. Drain 3 Bias can be connected from either pins 11 or 20.

3. The exposed pad centered on the package bottom must be connected to RF and DC ground.

* Restrictions on Hazardous Substances, European Union Directive 2002/95/EC.

3 W Power Amplifier 12.7 - 13.3 GHz

Rev. V1

Electrical Specifications: Freq. = 12.7 - 13.3 GHz, $V_D = 6\text{ V}$, $I_{DQ}^4 = 1200\text{ mA}$, $T_A = +25^\circ\text{C}$

Parameter	Units	Min.	Typ.	Max.
Small Signal Gain	dB	20.5	23	—
Input Return Loss	dB	—	15	—
Output Return Loss	dB	—	12	—
Noise Figure	dB	—	7	—
P1dB	dBm	—	34	—
P_{SAT}	dBm	34	34.5	—
Output IP3, +20 dBm SCL	dBm	39.5	42	—
Detector Bias Voltage (V_{DET} , V_{REF})	VDC	—	5.0	—

4. Adjust V_{G1} , V_{G2} and V_{G3} between -1.0 and -0.1 V to achieve specified I_{DQ} ($I_{DQ} = I_{D1} + I_{D2} + I_{D3}$). V_{G1} , V_{G2} and V_{G3} should be the same voltage.

Maximum Operating Ratings^{5,6,7}

Parameter	Absolute Max.
Input Power	+18 dBm
Drain Supply Voltage	+7 Volts
Junction Temperature ⁸	+160°C
Operating Temperature	-40°C to +85°C
Storage Temperature	-65°C to +150°C

- Exceeding any one or combination of these limits may cause permanent damage to this device.
- M/A-COM Technology Solutions does not recommend sustained operation near these survivability limits.
- Operating at nominal conditions with $T_J \leq 160^\circ\text{C}$ will ensure $MTTF > 1 \times 10^6$ hours.
- Junction Temperature (T_J) = $T_C + \Theta_{JC} * ((V * I) - (P_{OUT} - P_{IN}))$
Typical thermal resistance (Θ_{JC}) = 7.9°C/W
 - For $T_C = 25^\circ\text{C}$,
 $T_J = 91^\circ\text{C}$ @ 6 V, 1.85 A, $P_{OUT} = 34.5\text{ dBm}$, $P_{IN} = 14\text{ dBm}$
 - For $T_C = 85^\circ\text{C}$,
 $T_J = 146^\circ\text{C}$ @ 6 V, 1.75 A, $P_{OUT} = 34.5\text{ dBm}$, $P_{IN} = 14\text{ dBm}$

Absolute Maximum Ratings^{9,10}

Parameter	Absolute Max.
Supply Gate Voltage	-3 V
Supply Current	2200 mA
Drain to Gate Voltage	10 V
Detector Pin	6 V
Detector Ref Pin	6 V
Continuous Power Dissipation @ 85°C	11.3 W
Junction Temperature	175°C

- Channel temperature directly affects device MTTF. Channel temperature should be kept as low as possible to maximize lifetime.
- For saturated performance it is recommended that the sum of $(2 * V_{DD} + \text{abs}(V_{GG})) < 17\text{ V}$.

Recommended PCB Layout

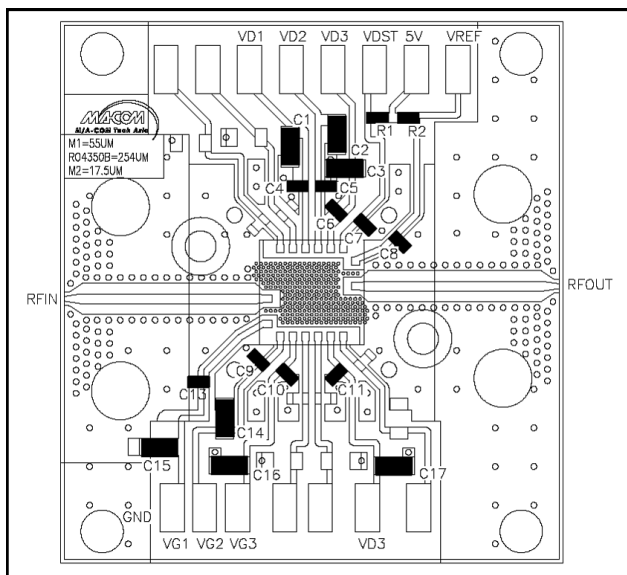

Schematic

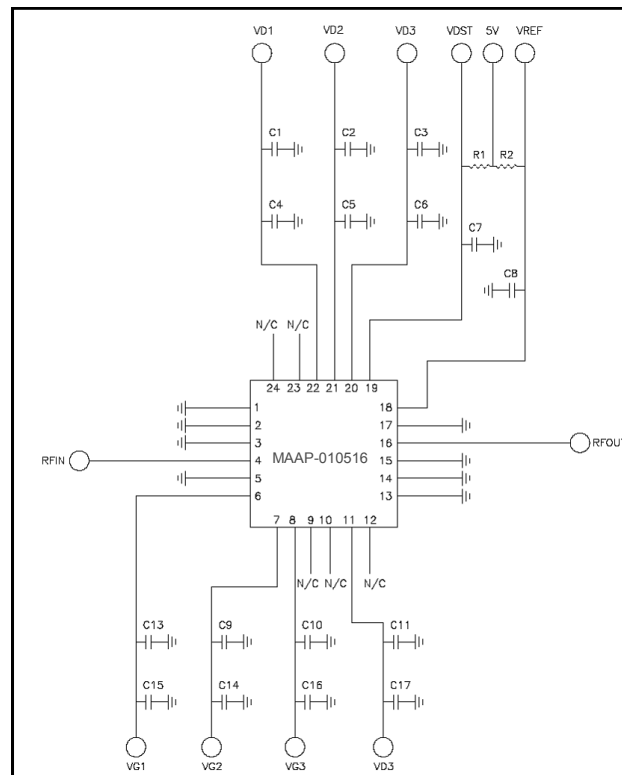

Parts List

Component	Value	Package
C1,C2,C3,C14, C15,C16,C17	2.2 μ F	0603
C4,C5,C6,C7,C8, C9,C10,C11,C13	1000 pF	0402
R1	100 K Ω	0402
R2	91 K Ω	0402

Handling Procedures

Please observe the following precautions to avoid damage:

Static Sensitivity

Gallium Arsenide Integrated Circuits are sensitive to electrostatic discharge (ESD) and can be damaged by static electricity. Proper ESD control techniques should be used when handling these Class 1A devices.

Typical Performance Curves

Gain

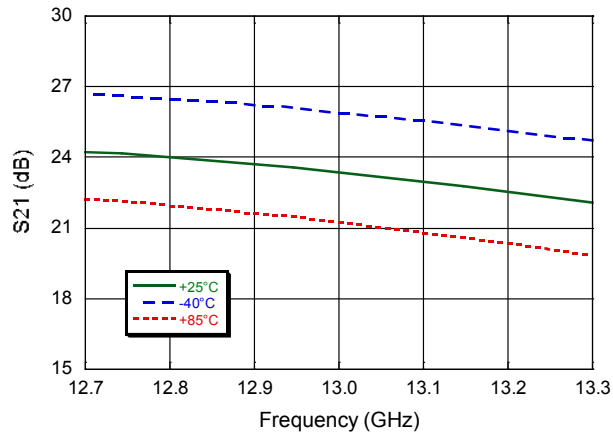

Noise Figure @ 25°C

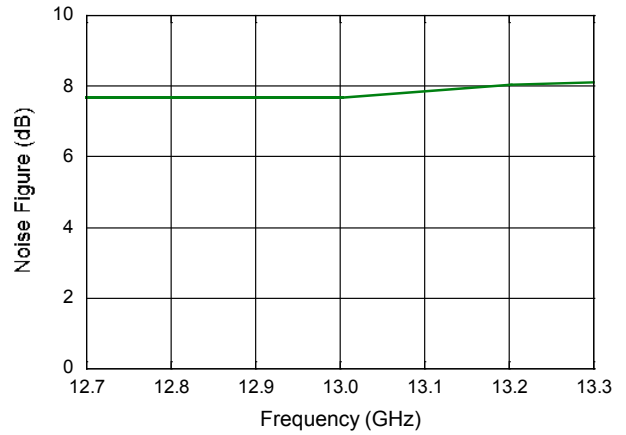

Input Return Loss

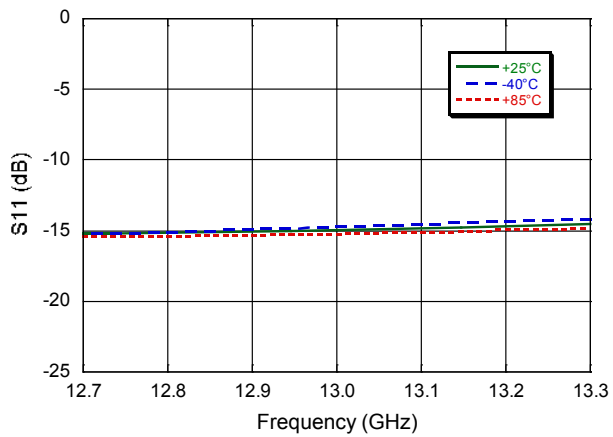

Output Return Loss

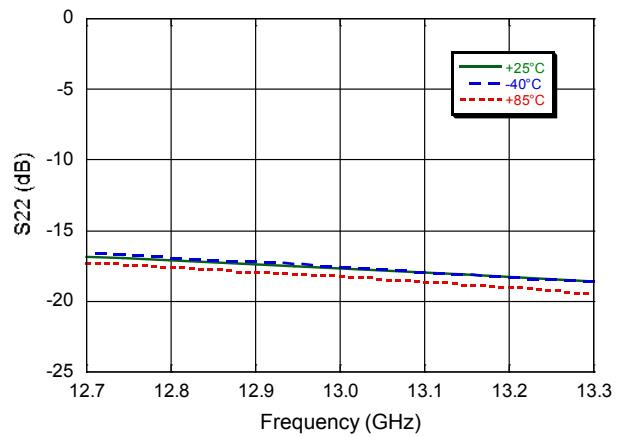

P1dB

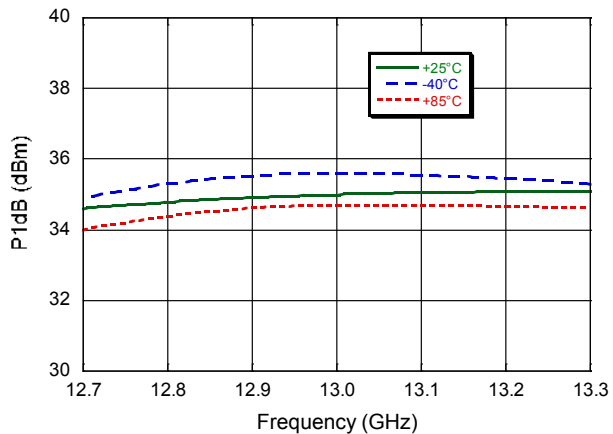

PSAT

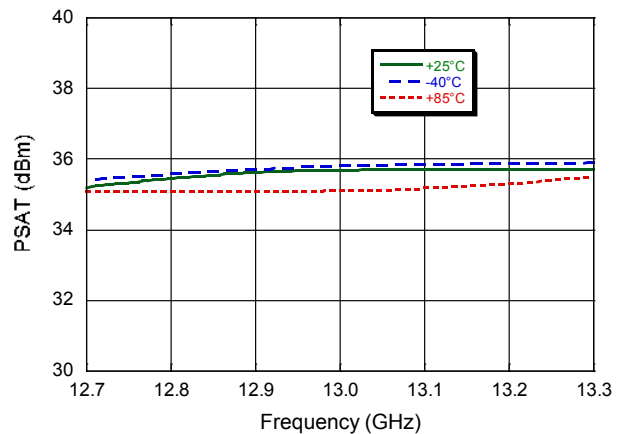

Typical Performance Curves

Output IP3 @ +25°C

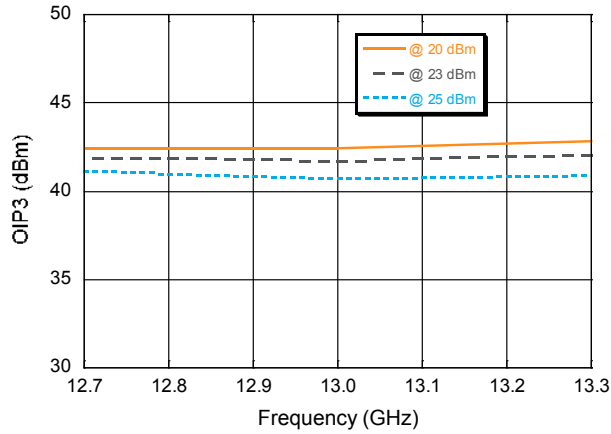

Output IP3 @ +25°C

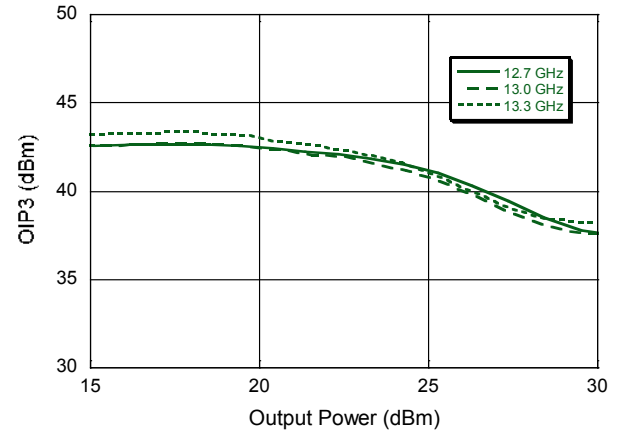

Output IP3 @ -40°C

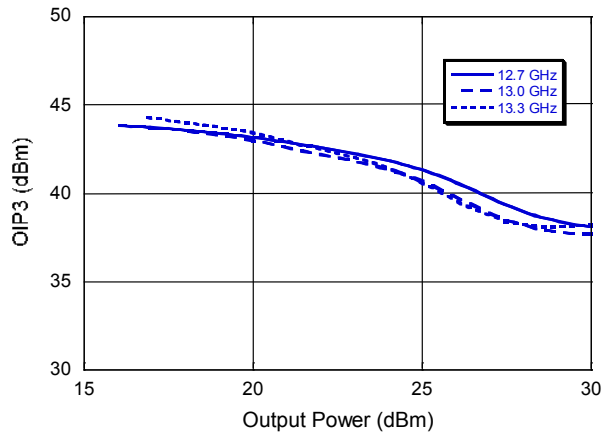

Output IP3 @ +85°C

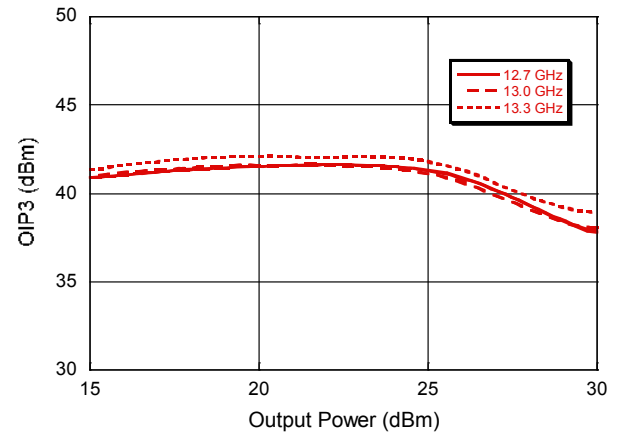

Typical Performance Curves

Power Data @ 12.7 GHz, +25°C

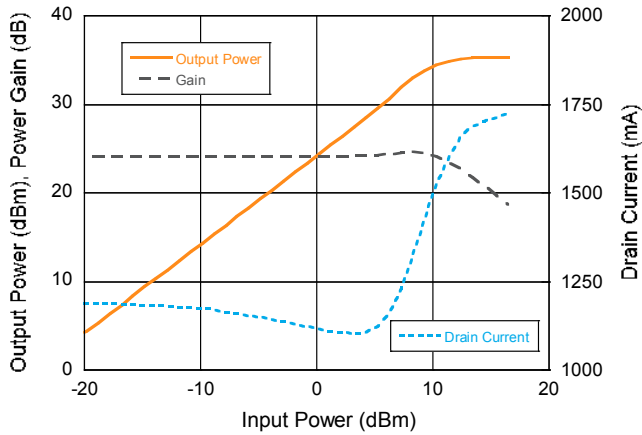

Power Data @ 12.7 GHz, -40°C

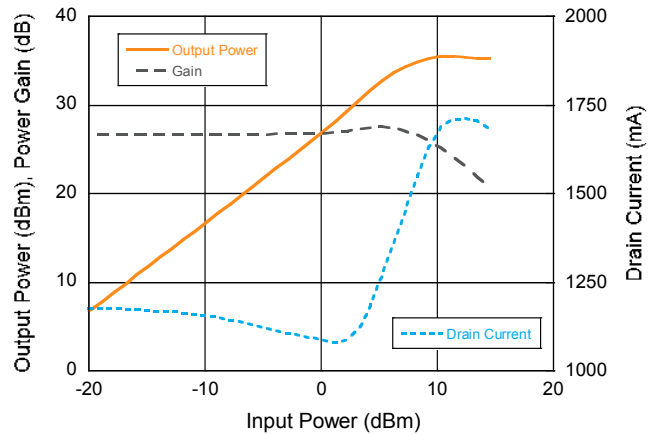

Power Data @ 13.0 GHz, +25°C

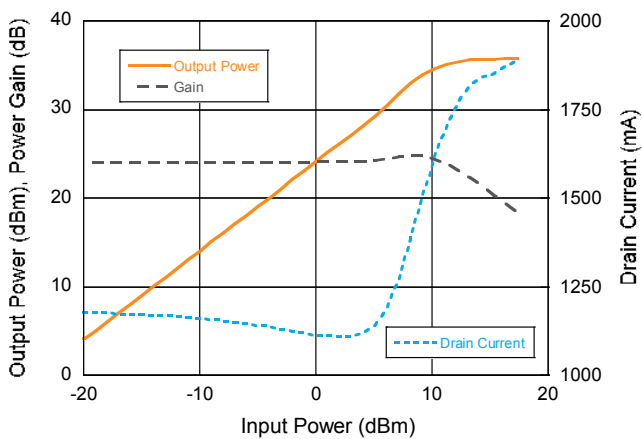

Power Data @ 13.0 GHz, -40°C

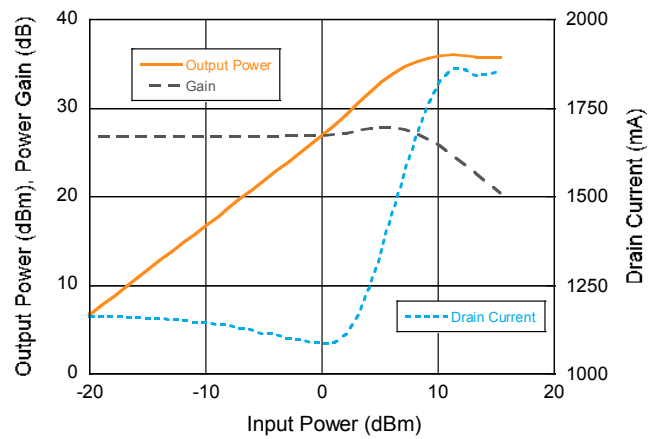

Power Data @ 13.3 GHz, +25°C

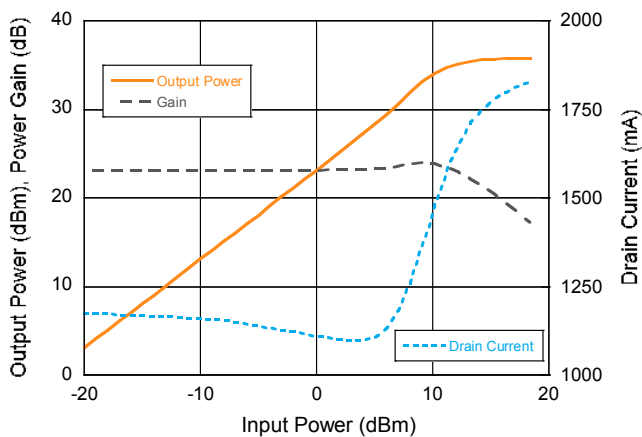

Power Data @ 13.3 GHz, -40°C

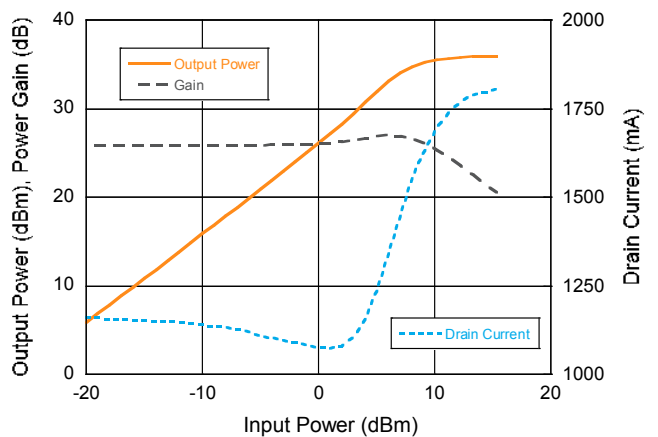

Typical Performance Curves

Power Data @ 12.7 GHz, +85°C

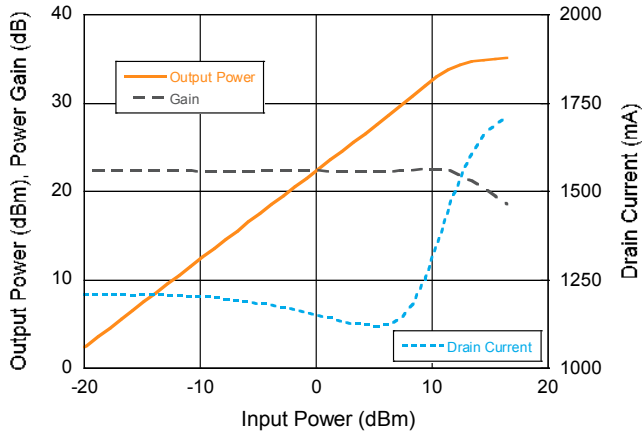

Detected Voltage ($V_{DET} - V_{REF}$) @ 25°C

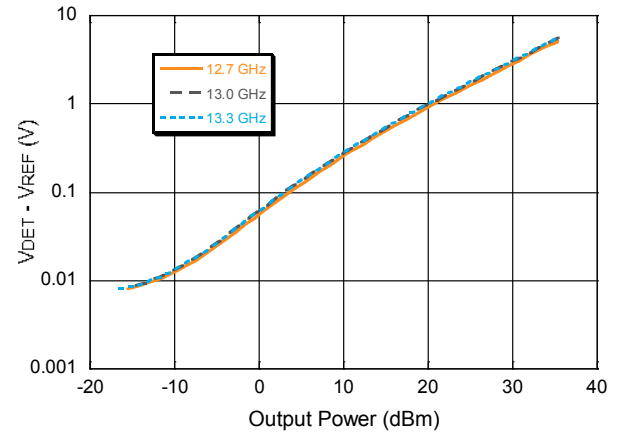

Power Data @ 13.0 GHz, +85°C

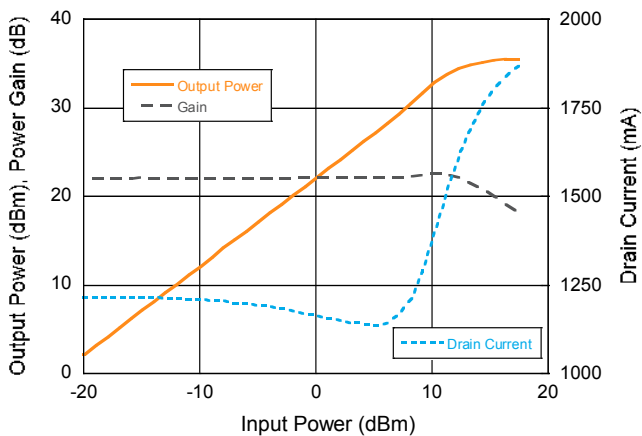

Power Data @ 13.3 GHz, +85°C

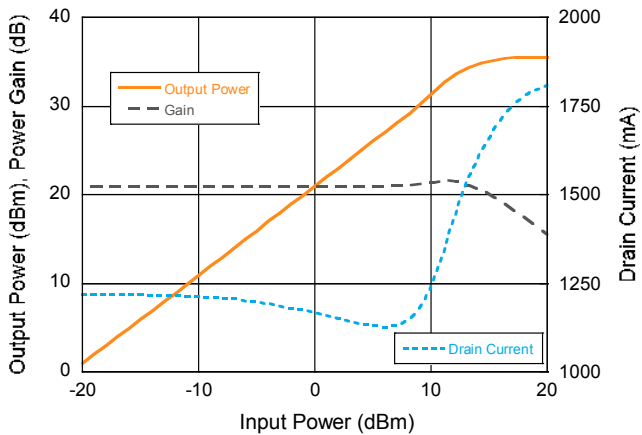

Lead-Free 5mm 24-lead PQFN

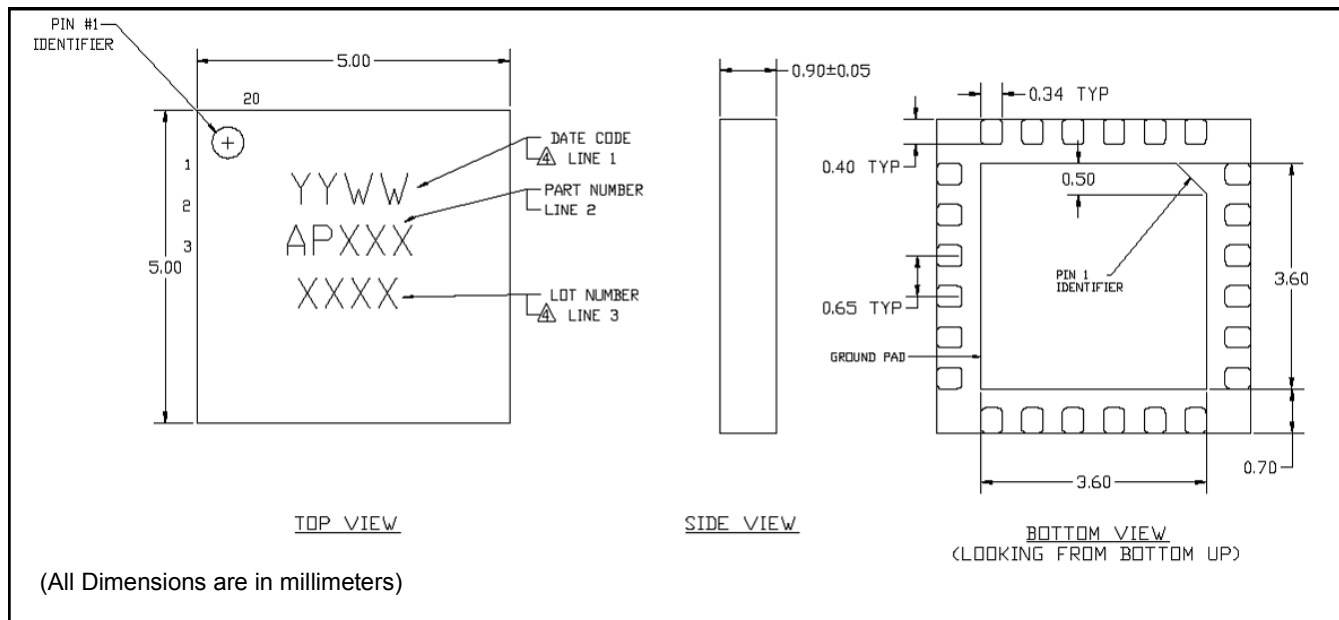

† Reference Application Note S2083 for lead-free solder reflow recommendations.
 Meets JEDEC moisture sensitivity level 1 requirements.
 Plating is matte tin over Copper.

M/A-COM Technology Solutions Inc. All rights reserved.

Information in this document is provided in connection with M/A-COM Technology Solutions Inc ("MACOM") products. These materials are provided by MACOM as a service to its customers and may be used for informational purposes only. Except as provided in MACOM's Terms and Conditions of Sale for such products or in any separate agreement related to this document, MACOM assumes no liability whatsoever. MACOM assumes no responsibility for errors or omissions in these materials. MACOM may make changes to specifications and product descriptions at any time, without notice. MACOM makes no commitment to update the information and shall have no responsibility whatsoever for conflicts or incompatibilities arising from future changes to its specifications and product descriptions. No license, express or implied, by estoppel or otherwise, to any intellectual property rights is granted by this document.

THESE MATERIALS ARE PROVIDED "AS IS" WITHOUT WARRANTY OF ANY KIND, EITHER EXPRESS OR IMPLIED, RELATING TO SALE AND/OR USE OF MACOM PRODUCTS INCLUDING LIABILITY OR WARRANTIES RELATING TO FITNESS FOR A PARTICULAR PURPOSE, CONSEQUENTIAL OR INCIDENTAL DAMAGES, MERCHANTABILITY, OR INFRINGEMENT OF ANY PATENT, COPYRIGHT OR OTHER INTELLECTUAL PROPERTY RIGHT. MACOM FURTHER DOES NOT WARRANT THE ACCURACY OR COMPLETENESS OF THE INFORMATION, TEXT, GRAPHICS OR OTHER ITEMS CONTAINED WITHIN THESE MATERIALS. MACOM SHALL NOT BE LIABLE FOR ANY SPECIAL, INDIRECT, INCIDENTAL, OR CONSEQUENTIAL DAMAGES, INCLUDING WITHOUT LIMITATION, LOST REVENUES OR LOST PROFITS, WHICH MAY RESULT FROM THE USE OF THESE MATERIALS.

MACOM products are not intended for use in medical, lifesaving or life sustaining applications. MACOM customers using or selling MACOM products for use in such applications do so at their own risk and agree to fully indemnify MACOM for any damages resulting from such improper use or sale.

M/A-COM Technology Solutions Inc. (MACOM) and its affiliates reserve the right to make changes to the product(s) or information contained herein without notice.
Visit www.macom.com for additional data sheets and product information.