

REV.	ECN. NO.	NAME	DATE

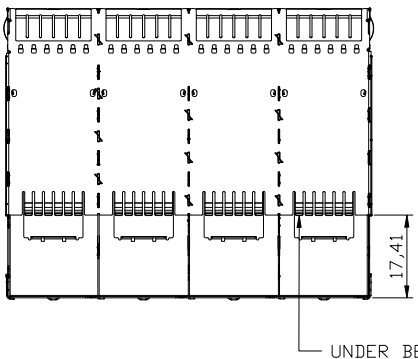

PART NUMBER SELECTION

P/N	REAR LEGS OPTIONALS
HT10-5014100-00S	1 LEG PER PORT
HT10-5014000-00S	0 LEG PER PORT

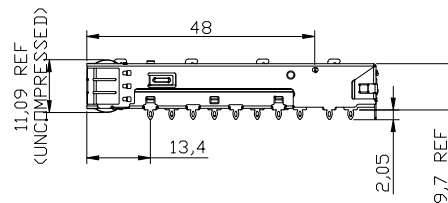
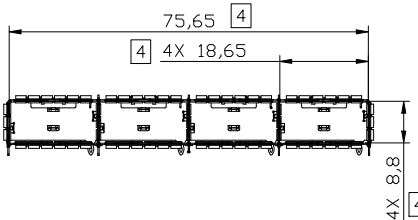
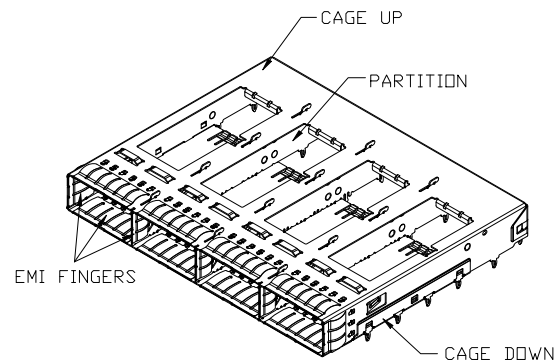
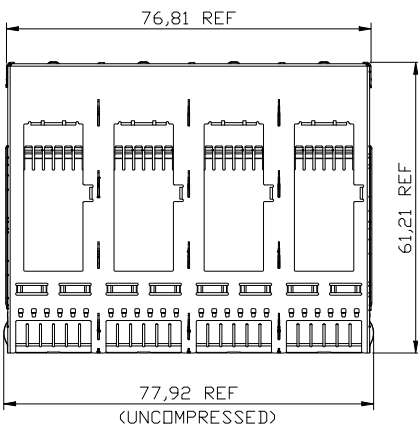
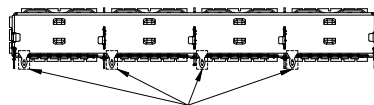

REAR LEGS ARE OPTIONAL:
1 LEG OR NO LEG

- MATERIALS:
CAGE UP: STAINLESS STEEL, 0,25 THICKNESS
CAGE DOWN: STAINLESS STEEL, 0,25 THICKNESS
PARTITION: STAINLESS STEEL
EMI FINGERS: STAINLESS STEEL
HEATSINK: ALUMINUM
HEATSINK CLIP: STAINLESS STEEL
LIGHT PIPE MATERIAL: CLEAR POLYCARBONATE
CAP: THERMOPLASTIC 94V-0,BLACK
- SURFACE FINISH:
BODY CAGE: CLEANING
EMI SPRING FINISH: CLEANING AND HOLE SEALING
HEATSINK FINISH: BLACK ANODIZED
HEATSINK CLIP FINISH: CLEANING
- MATE WITH QSFP MSA COMPATIBLE TRANSCEIVER.
- INSIDE SURFACE OF CASKET WHEN FULLY COMPRESSED.
- REFERENCE DOCUMENTS:
PRODUCT SPECIFICATION: SFF-8663
- THIS PRODUCT COMPLY TO ROHS DIRECTIVE 2011/65/EU.

S148 X X X 1 X

1 2 3 4

- REAR LEGS:
0=W/O REAR LEG
1=W/ 1 REAR LEG
- LIGHT PIPE & CAP OPTION:
0=W/O Light Pipe, W/O CAP
1=W/ Light Pipe, W/O CAP
2=W/ Light Pipe, W/ CAP
- LIGHT PIPE DIM "A" & PLATING OPTION:
0=W/O Light Pipe
1=DIM A=10.7mm, W/O Silver Color plating
2=DIM "A"=9.7mm, W/O Silver Color plating
3=DIM A=10.7mm, W/Silver Color plating
4=DIM "A"=9.7mm, W/Silver Color plating
- PROCESS OPTION:
0=W/O Heatsink, Open Top
1=W/PC(Heatsink 4.2mm)
2=W/SAN(Heatsink 6.5mm)
3=W/Networking(Heatsink 13.5mm)

REAR LEGS OPTIONALS

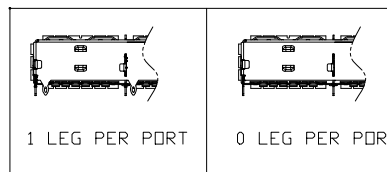

REMARK: APPLIES TO ALL CAGES IN THIS DRAWING

RoHS Compliant

TOLERANCE UNSPECIFIED				FOR YOUR VITAL CONNECTION	
.0	± 0.38				
.00	± 0.25	TITLE: QSFP+28G 1X4 CAGE			
.000	± 0.10	DRAWN BY:	BECKER	PART NO:	S148 X X X 1 X
ANGLE	± 3.00°	CHECKED BY:	VTA	SIZE: A4	UNIT:mm
MANUFACTURING COPY		APPROVED BY:	QPF	PROJECTION	
				SHEET:10F7	REV: A
				FCN: A4	http://www.vitalconn.com

REV.	ECN. NO.	NAME	DATE

WITH HEATSINK, WITH LIGHT PIPES
 LIGHT PIPE WITHOUT SILVER COLOR PLATING

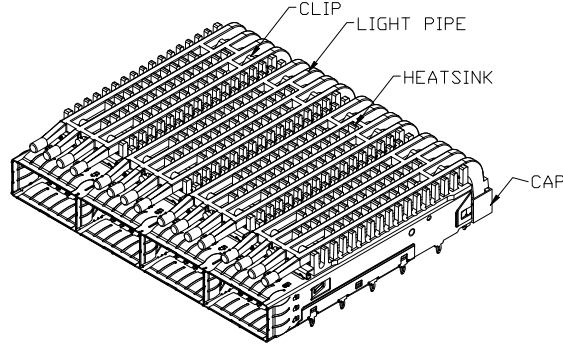
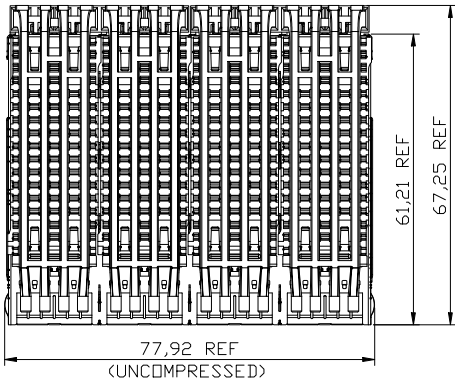

HEATSINK OPTIONALS

OVERALL HEATSINK HEIGHT	DIM "H"	
	BEFORE MODULE INSTALLING	AFTER MODULE INSTALLING
PCI HS (4.2mm)	12.8	13.7
SAN HS (6.5mm)	15.1	16.0
NET HS (13.5mm)	22.1	23.0

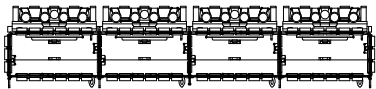
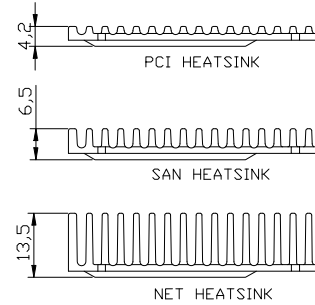

DIM "A" ±0.3
 FROM FIRST LEG TO LIGHT PIPE

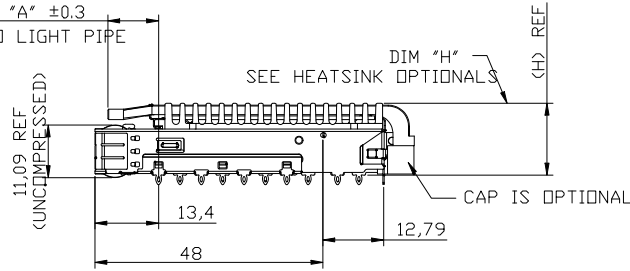

PART NUMBER SELECTION

10.7	NET(13.5mm)	1	W/ CAP
9.7	NET(13.5mm)	1	W/ CAP
10.7	SAN(6.5mm)	1	W/ CAP
9.7	SAN(6.5mm)	1	W/ CAP
10.7	PCI(4.2mm)	1	W/ CAP
9.7	PCI(4.2mm)	1	W/ CAP
10.7	NET(13.5mm)	0	W/ CAP
9.7	NET(13.5mm)	0	W/ CAP
10.7	SAN(6.5mm)	0	W/ CAP
9.7	SAN(6.5mm)	0	W/ CAP
10.7	PCI(4.2mm)	0	W/ CAP
9.7	PCI(4.2mm)	0	W/ CAP
DIM A	HEAT SINK	REAR LEGS OPTIONALS	CAP OPTIONALS

CAP OPTIONALS

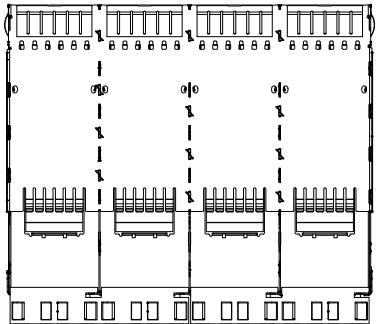
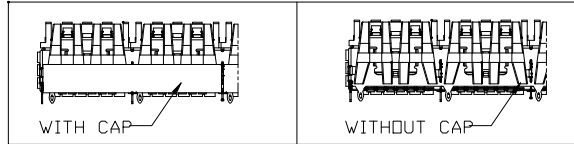

RoHS Compliant

TOLERANCE UNSPECIFIED		VITALCON a vital connector company		FOR YOUR VITAL CONNECTION	
.0	± 0.38			TITLE: QSFP+28G 1X4 CAGE	
.00	± 0.25	DRAWN BY:	BECKER	PART NO:	S148 X X X 1 X
.000	± 0.10	CHECKED BY:	VTA	SIZE: A4	UNIT:mm
ANGLE	± 3.00°	APPROVED BY:	QPF	PROJECTION	SHEET:20F7
MANUFACTURING COPY				FCN: A4	REV: A
				http://www.vitalconn.com	

REV.	ECN. NO.	NAME	DATE

WITH HEATSINK, WITH LIGHT PIPES
LIGHT PIPE WITH SILVER COLOR PLATING

HEATSINK OPTIONALS

OVERALL HEATSINK HEIGHT	DIM "H"	
	BEFORE MODULE INSTALLING	AFTER MODULE INSTALLING
PCI HS (4.2mm)	12.8	13.7
SAN HS (6.5mm)	15.1	16.0
NET HS (13.5mm)	22.1	23.0

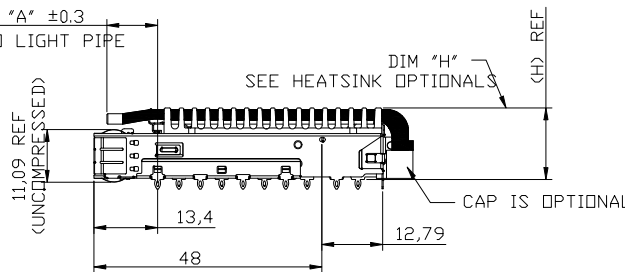
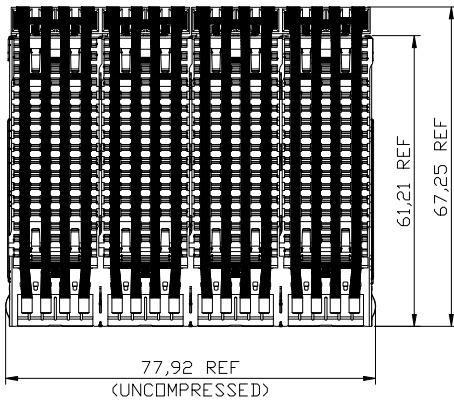
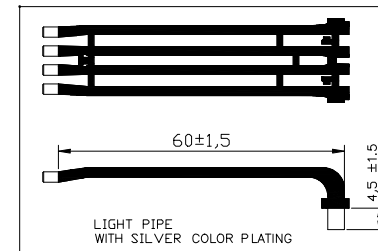
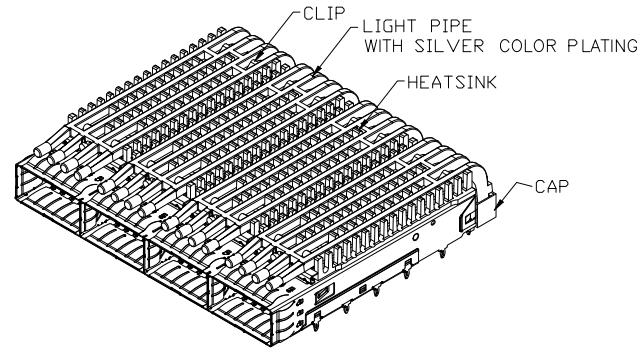

PART NUMBER SELECTION

10.7	NET(13.5mm)	1	W/ CAP
9.7	NET(13.5mm)	1	W/ CAP
10.7	SAN(6.5mm)	1	W/ CAP
9.7	SAN(6.5mm)	1	W/ CAP
10.7	PCI(4.2mm)	1	W/ CAP
9.7	PCI(4.2mm)	1	W/ CAP
10.7	NET(13.5mm)	0	W/ CAP
9.7	NET(13.5mm)	0	W/ CAP
10.7	SAN(6.5mm)	0	W/ CAP
9.7	SAN(6.5mm)	0	W/ CAP
10.7	PCI(4.2mm)	0	W/ CAP
9.7	PCI(4.2mm)	0	W/ CAP
DIM A	HEAT SINK	REAR LEGS OPTIONALS	CAP OPTIONALS

CAP OPTIONALS

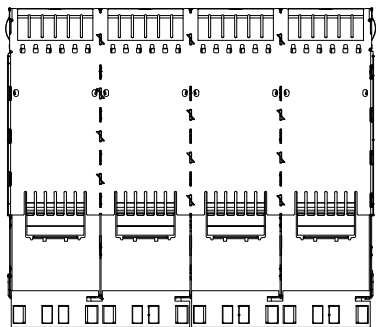
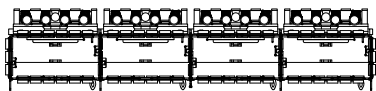
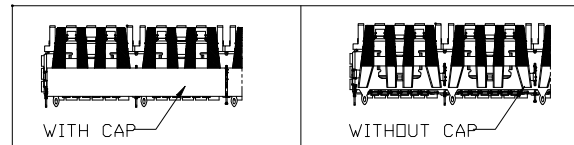

RoHS Compliant

TOLERANCE UNSPECIFIED		VITALCON a vital connector company		FOR YOUR VITAL CONNECTION	
.0	± 0.38				
.00	± 0.25	TITLE: QSFP+28G 1X4 CAGE			
.000	± 0.10				
ANGLE	± 3.00°	PART NO:		S148 X X X 1 X	
MANUFACTURING COPY		REV: A		REV: A	
DRAWN BY:	BECKER	SIZE: A4	UNIT:mm	SHEET:30F7	FCN: A4
CHECKED BY:	VTA	PROJECTION	http://www.vitalconn.com		
APPROVED BY:	QPF				

REV.	ECN. NO.	NAME	DATE

BEZEL AND BOARD POSITION DIMENSION
FOR SINGLE SIDE MOUNTING (SPRING FINGER)

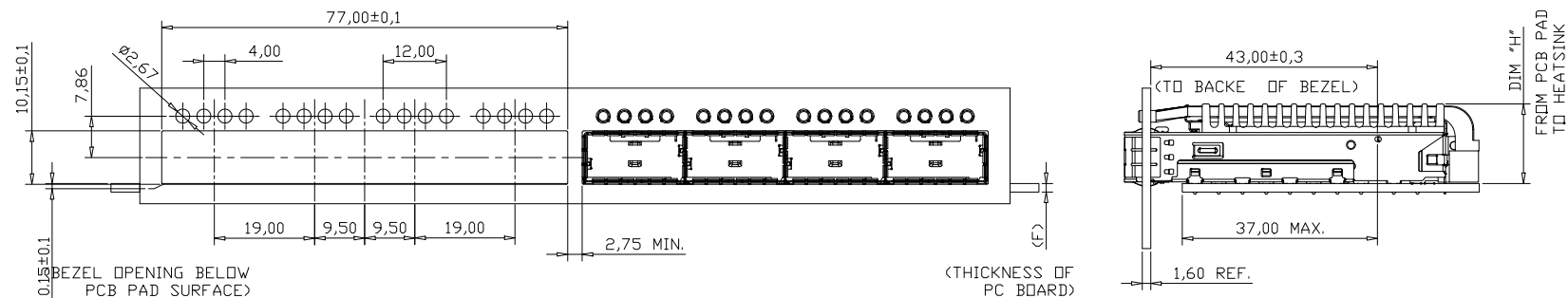

BEZEL AND BOARD POSITION DIMENSION
FOR BELLY TO BELLY MOUNTING (SPRING FINGER)

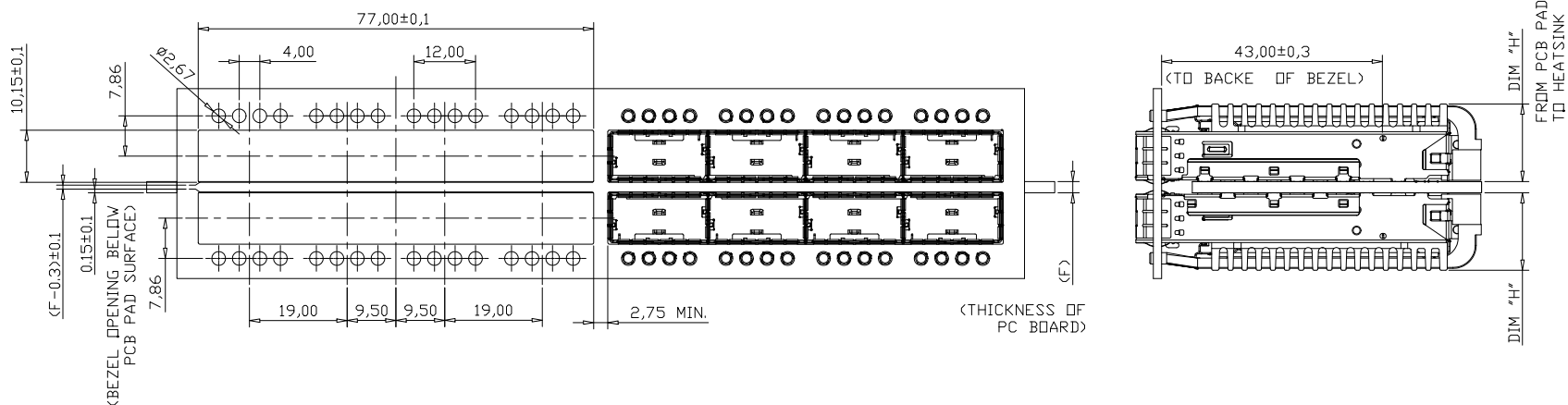

NOTES:

1. THE NORMAL THICKNESS OF CUSTOMER SUPPLIED PC BOARD.(DIM. "F")
SINGLE SIDED PC BOARD THICKNESS: 1.60mm MIN.
BELLY TO BELLY PC BOARD MIN. THICKNESS: 3.0mm MIN.
2. GENERAL TOLERANCE: $\pm 0,05$.

RoHS Compliant

TOLERANCE UNSPECIFIED		 VITALCON a vital connector company		FOR YOUR VITAL CONNECTION	
.0	± 0.38				
.00	± 0.25	TITLE: QSFP+28G 1X4 CAGE			
.000	± 0.10	DRAWN BY:	BECKER	PART NO:	S148 X X X 1 X
ANGLE	$\pm 3.00^\circ$	CHECKED BY:	VTA	SIZE: A4	UNIT:mm
MANUFACTURING COPY		APPROVED BY:	QPF	PROJECTION	 http://www.vitalconn.com
					REV: A
					FCN: A4

REV.	ECN. NO.	NAME	DATE

		THE DIMENSION FOR MATING BEZEL (UNIT: mm)						
CODE	L/P APPEARANCE	L/P CUT-OUT	L/P PITCH (FRONT)	L/P PITCH (REAR)	L/P HEIGHT	BEZEL THICKNESS	LED HEIGHT	REMARK
0	NO L/P							WITHOUT LIGHT PIPE
A	ROUND	∅2.67	4.00(Equal)	1,4=15.75 2,3=3.40	7.86	1.60	0.8~1.1	APPLIES TO QUAD L/P
		①	②	③	④	⑤	⑥	

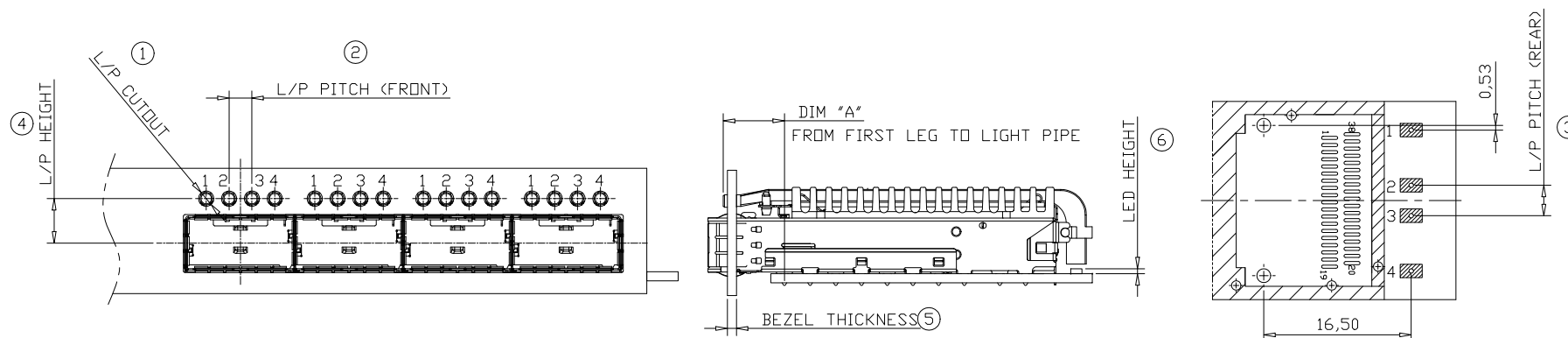

RoHS Compliant

TOLERANCE UNSPECIFIED		VITALCON a vital connector company		FOR YOUR VITAL CONNECTION	
.0	± 0.38			TITLE: QSFP+28G 1X4 CAGE	
.00	± 0.25	DRAWN BY: BECKER		PART NO: S148 X X X 1 X	
.000	± 0.10	CHECKED BY: VTA		SIZE: A4	
ANGLE	± 3.00°	APPROVED BY: QPF		UNIT:mm	
MANUFACTURING COPY		PROJECTION		SHEET:50F7	
				REV: A	
				FCN: A4	
				http://www.vitalconn.com	

REV.	ECN. NO.	NAME	DATE

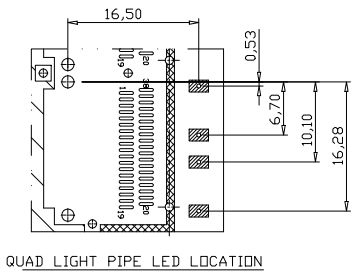
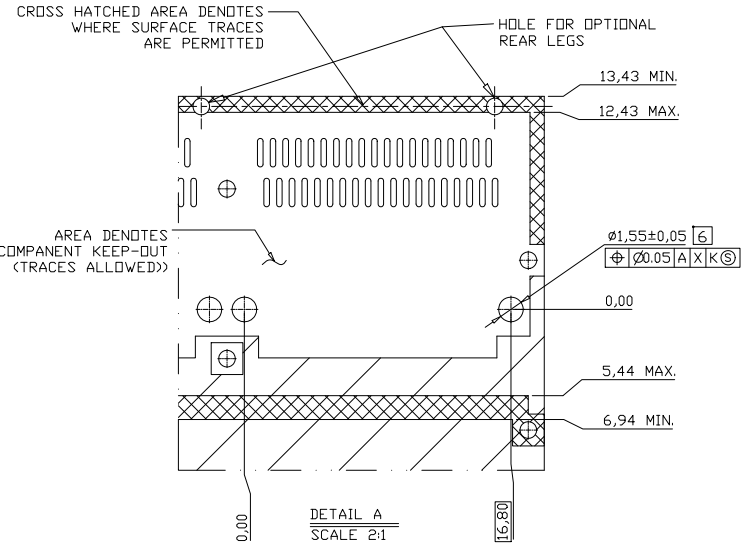
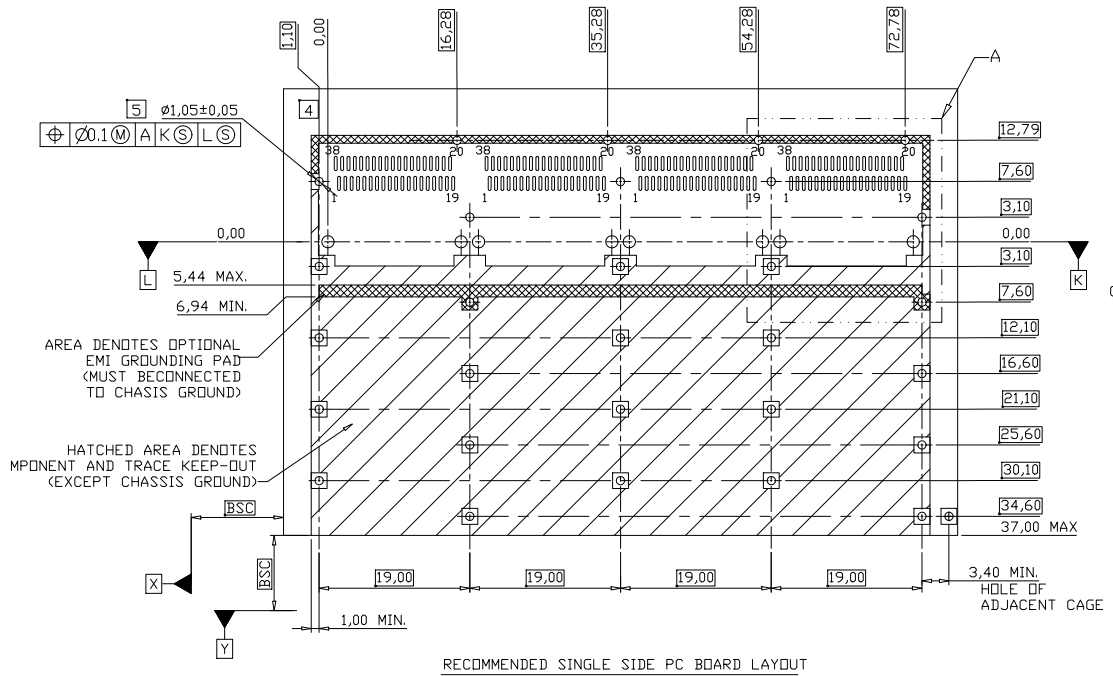

- NOTES:
- DATUM X & Y ARE ESTABLISHED BY THE CUSTOMER'S FIDUCIAL
 - DATUM A IS THE TOP SURFACE OF THE HOST BOARD
 - LOCATION OF THE EDGE OF PCB IS APPLICATION SPECIFIC
 - BASELINE FOR THESE DIMENSIONS IS THE CENTER OF COMPLIANT PIN HOLE.
 - FINISHED HOLE SIZE
 - UNPLATED THRU HOLE.
 - REFER TO SFF8662 FOR CONNECTOR FOOTING DIMENSIONS

RoHS Compliant

TOLERANCE UNSPECIFIED		VITALCON a vital connector company		FOR YOUR VITAL CONNECTION	
.0	± 0.38				
.00	± 0.25	TITLE: QSFP+28G 1X4 CAGE			
.000	± 0.10	DRAWN BY:	BECKER	PART NO:	S148 X X X 1 X
ANGLE	± 3.00°	CHECKED BY:	VTA	SIZE:	A4
MANUFACTURING COPY		APPROVED BY:	QPF	PROJECTION	http://www.vitalconn.com
		REV:	A	SHEET:	6OF7
		FCN:	A4		

