



PRODUCT SPECIFICATION

REV A January 2011

Oscilent Controlled Document

Ordering Code / Part Number	Product Description
835-IF115.0M-12B	115.0MHz IF SAW Filter 12.68 MHz Bandwidth

Specification Contents

- o Mechanical Dimensions
- o Test Circuit
- o Maximum Ratings
- o Electrical Specification
- o Frequency Response
- o Smith Chart
- o VSWR

Notes

- o Electrostatic Sensitive Device (ESD) 
- o Avoid excessive ultrasonic exposure
- o Solderability compatible with JEDEC J-STD-020C Pb-free process, 260°C peak reflow temperature
- o This product complies with EU directive 2002/95/EC (RoHS compliance)





Mechanical Dimensions (mm)

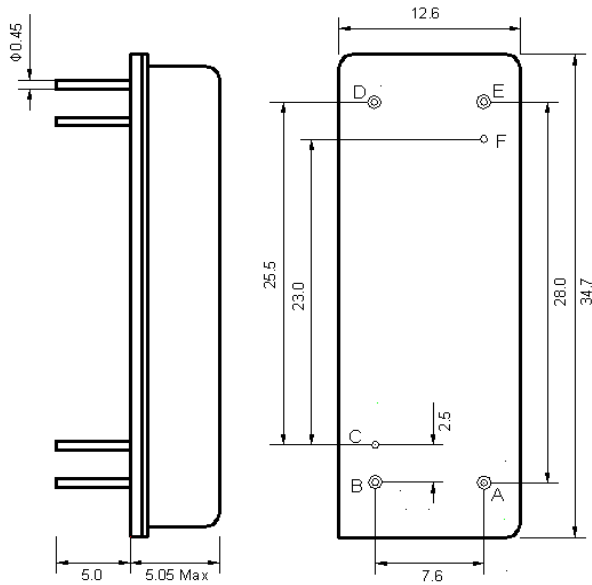

Pin Description	
B, C, D, F	Ground
A	In
E	Out

Test Circuit

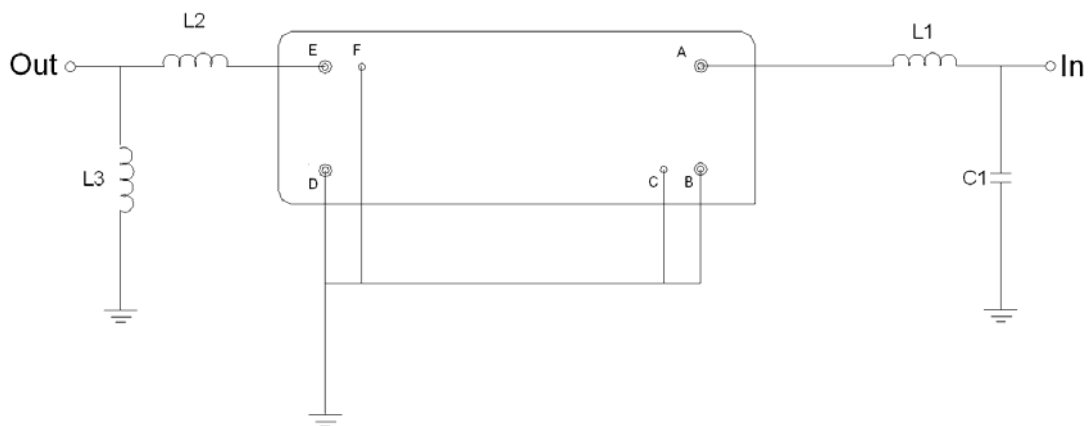

Test Fixture & Values	
Input	L1=56 nH, C1=75 pF
Output	L2=3.3 nH, L3=39 nH
Source/Load Impedance	50 Ω



Maximum Ratings

Parameters Description	Unit	Minimum	Typical	Maximum
Operating Temperature Range	°C	20	-	70
Storage Temperature Range	°C	20	-	70
Maximum DC Voltage	V	-	-	10
Maximum Input Power	dBm	-	-	10
Source Impedance (single ended) ⁽¹⁾	Ω	-	50	-
Load Impedance (single ended) ⁽¹⁾	Ω	-	50	-

Notes: With Matching Network (Ref. Testing Environment Circuit as shown above).

Those impedances could be modified with different impedance values and/or structures, if necessary.

Electrical Specification

Parameters Description	Unit	Minimum	Typical	Maximum
Center Frequency (Fo)	MHz	-	115.0	-
Insertion Loss at Fo	dB	-	25.50	27.00
Group Delay Variation (Fo±6.25MHz)	nsec	-	65	100
Absolute Delay Time at Fo	usec	-	4.70	-
Temperature Coefficient	ppm/°C	-	-18	-
Amplitude Ripple (Fo±6.25MHz)	dB	-	0.65	1.00
Bandwidth at -1dB	MHz	12.60	12.68	-
Bandwidth at -3dB	MHz	-	12.89	-
Bandwidth at -10dB	MHz	-	13.19	13.25
Bandwidth at -20dB	MHz	-	13.41	-
Bandwidth at -25dB	MHz	-	13.49	-
Bandwidth at -35dB	MHz	-	13.58	-
Relative Attenuation				
Out of Gain ± 400KHz	dB	9	14	-
Out of Gain ± 600KHz	dB	20	44	-
Out of Gain ± 1MHz	dB	45	60	-
Out of Gain ± 5MHz	dB	50	60	-



Frequency Response

Bandwidth at -1.0 dB

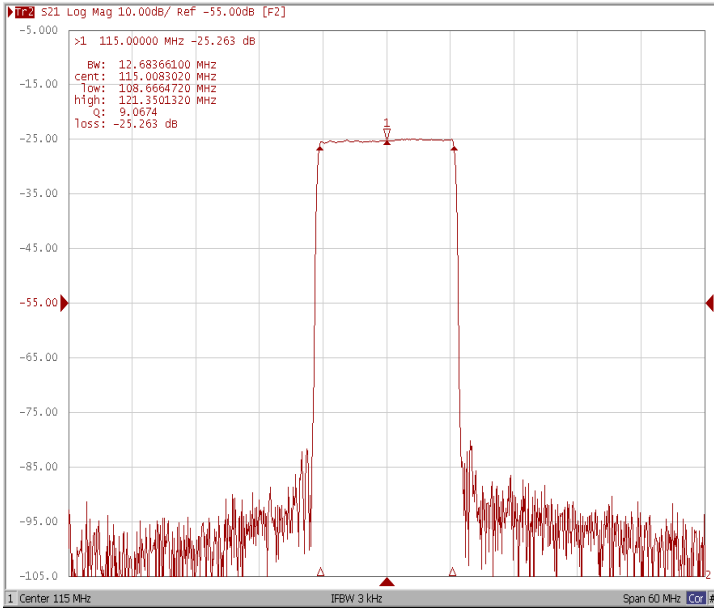

Bandwidth at -3.0 dB

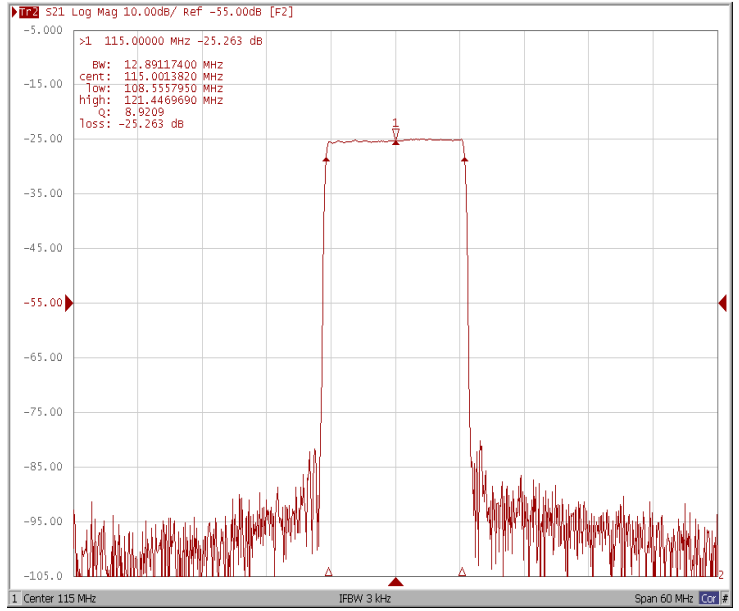

Bandwidth at -10.0 dB

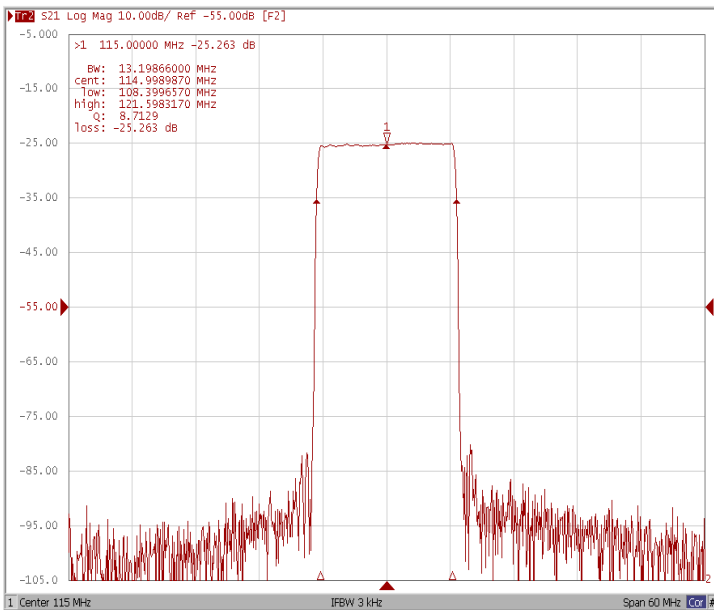

Relative Attenuation

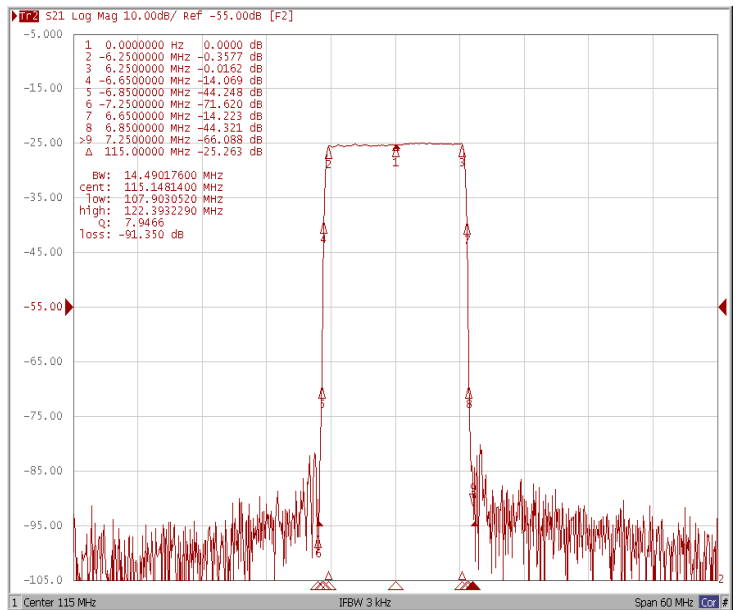



Ripple Variation Fo±6.25MHz

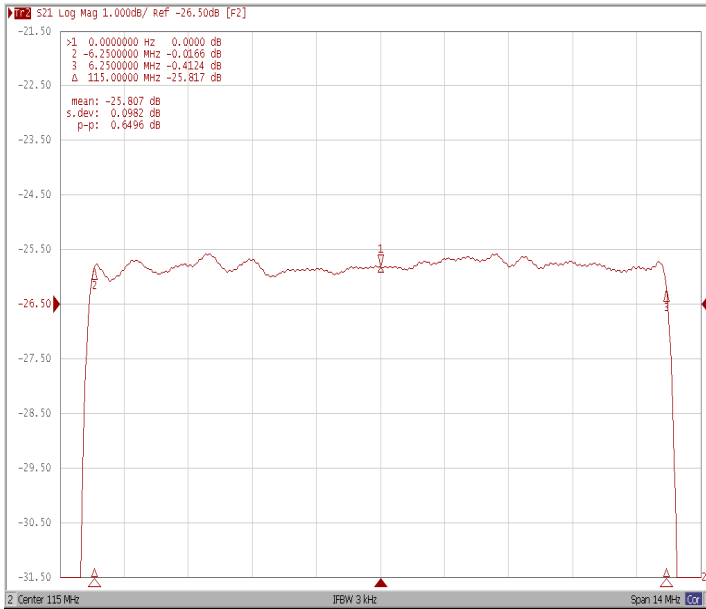

Group Delay Variation Fo±6.25MHz

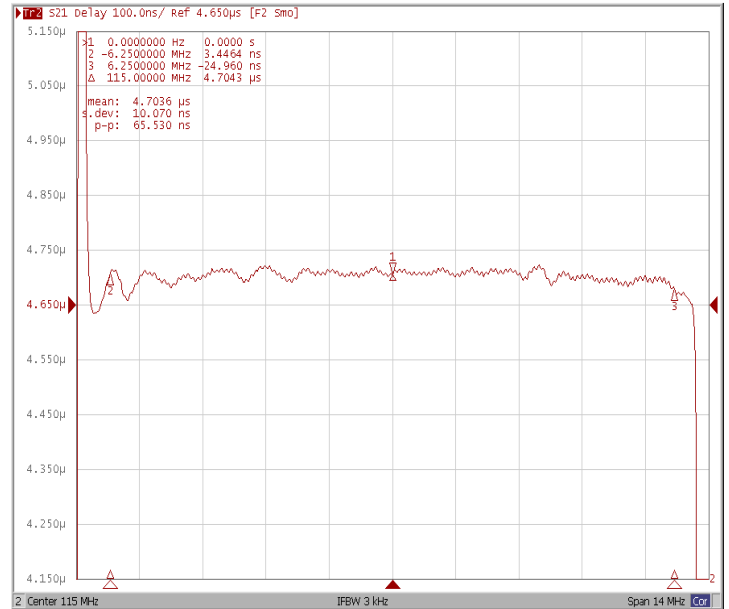

Smith Chart

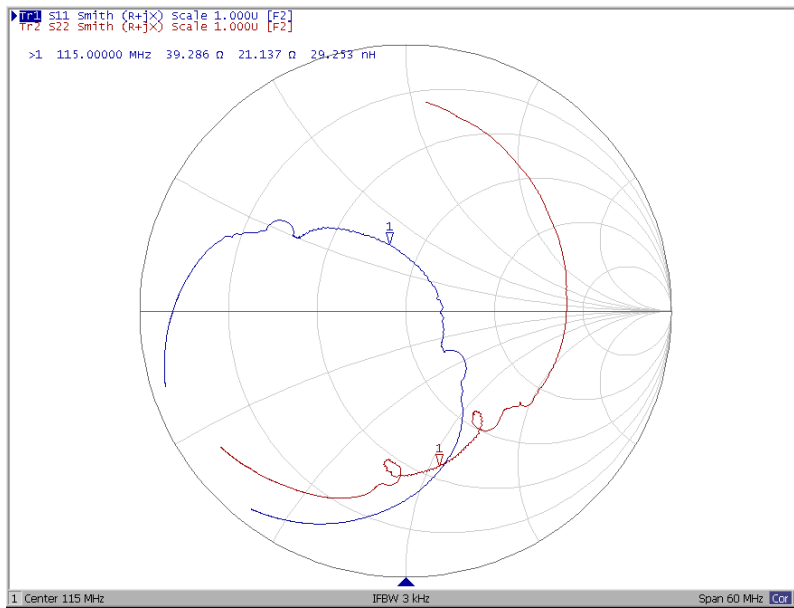



VSWR

