

218 Series, 5x20 mm, Time-Lag Fuse



Agency Approvals

| Agency | Agency File Number | Ampere Range |
|--------|--|--|
| | Cartridge: NBK090205-E10480A NBK120802-E10480C | 1A – 5A 6.3A – 15A |
| | Leaded: NBK090205-E10480B NBK120802-E10480D | 1A – 5A 6.3A – 15A |
| | 2005010207145715 | 0.032A – 6.3A |
| | SU05001-3005 SU05001-2008 SU05001-2009 | 0.032A – 0.040A 0.050A – 0.800A 1A – 10A |
| | E10480 | 0.032A – 16A |
| | 29862 | 0.032A - 10A; 15A |
| | 1620064 | 0.032A – 6.3A |
| | 40013496 | 0.032A – 10A |
| | 40016604 | 15A* |
| | KM41462 | 0.080A – 6.3A |
| | N/A | 0.032A – 16A |

* Approval for Cartridge versions only

Description

The 218 series fuse is a 5x20mm time-lag glass body cartridge fuse designed to IEC specification.

Features

- Designed to International IEC Standards for use globally
- Meets the IEC 60127-2, Sheet 3 specification for Time-Lag fuses
- Available in cartridge and axial lead form
- RoHS compliant and lead-free

Applications

Used as supplementary protection in appliance or utilization equipment to provide individual protection for components or internal circuits.

Additional Information



Datasheet



Resources



Samples



Accessories

For recommended fuse accessories for this product series, see '[Recommended Accessories](#)' section.

Electrical Characteristics

| % of Ampere Rating | Ampere Rating | Opening Time |
|--------------------|---------------|-----------------------------|
| 150% | 0.032A-0.100A | 60 minutes, Minimum |
| | 0.125A-6.3A | 60 minutes, Minimum |
| | 8A-15A | 30 minutes, Minimum |
| 210% | 0.032A-0.100A | 120 sec., Maximum |
| | 0.125A-6.3A | 120 sec., Maximum |
| | 8A-16A | 120 sec., Maximum |
| 275% | 0.032A-0.100A | 200 ms., Min.; 10 sec. Max. |
| | 0.125A-6.3A | 600 ms., Min.; 10 sec. Max. |
| | 8A-16A | 600 ms., Min.; 10 sec. Max. |
| 400% | 0.032A-0.100A | 40 ms., Min.; 3 sec. Max. |
| | 0.125A-6.3A | 150 ms., Min.; 3 sec. Max. |
| | 8A-15A | 150 ms., Min.; 3 sec. Max. |
| 1000% | 0.032A-0.100A | 10 ms., Min.; 300 ms. Max. |
| | 0.125A-6.3A | 20 ms., Min.; 300 ms. Max. |
| | 8A-15A | 20 ms., Min.; 300 ms. Max. |

Electrical Characteristics

| Amp Code | Amp Rating (A) | Voltage Rating (V) | Interrupting Rating | Nominal Cold Resistance (Ohms) | Nominal Melting I ² t (A ² sec) | Maximum Voltage Drop at Rated Current (mV) | Maximum Power Dissipation At 1.5In(W) | Agency Approvals | | | | | | | | | |
|----------|----------------|--------------------|---------------------|--------------------------------|---|--|---------------------------------------|------------------|-----|------|--------|----|----|----|-----|----|---|
| | | | | | | | | UL | CCC | PS E | RU | SF | CS | CE | D'E | | |
| .032 | 0.032 | 250 | 35 A @ 250 VAC | 48.2580 | 0.01100 | 5000 | 1.6 | | x | x | | x | x | x | x | x | |
| .040 | 0.04 | 250 | | 31.8620 | 0.01100 | 4000 | 1.6 | | x | x | | x | x | x | x | x | x |
| .050 | 0.05 | 250 | | 21.2920 | 0.02700 | 3500 | 1.6 | | x | x | | x | x | x | x | x | x |
| .063 | 0.063 | 250 | | 14.2680 | 0.04600 | 3000 | 1.6 | | x | x | | x | x | x | x | x | x |
| .080 | 0.08 | 250 | | 9.0700 | 0.07500 | 2500 | 1.6 | x | x | x | | x | x | x | x | x | x |
| .100 | 0.1 | 250 | | 6.0180 | 0.07900 | 2000 | 1.6 | x | x | x | | x | x | x | x | x | x |
| .125 | 0.125 | 250 | | 4.2000 | 0.1465 | 1900 | 1.6 | x | x | x | | x | x | x | x | x | x |
| .160 | 0.16 | 250 | | 3.7000 | 0.14400 | 1500 | 1.6 | x | x | x | | x | x | x | x | x | x |
| .200 | 0.2 | 250 | | 1.6000 | 0.3410 | 1300 | 1.6 | x | x | x | | x | x | x | x | x | x |
| .250 | 0.25 | 250 | | 1.0495 | 0.5405 | 1100 | 1.6 | x | x | x | | x | x | x | x | x | x |
| .315 | 0.315 | 250 | | 0.8475 | 1.1100 | 1000 | 1.6 | x | x | x | 1.1100 | x | x | x | x | x | x |
| .400 | 0.4 | 250 | | 0.5350 | 1.3250 | 900 | 1.6 | x | x | x | | x | x | x | x | x | x |
| .500 | 0.5 | 250 | | 0.3700 | 2.8250 | 300 | 1.6 | x | x | x | | x | x | x | x | x | x |
| .630 | 0.63 | 250 | | 0.2750 | 4.6750 | 250 | 1.6 | x | x | x | | x | x | x | x | x | x |
| .800 | 0.8 | 250 | | 0.0813 | 3.370 | 150 | 1.6 | x | x | x | | x | x | x | x | x | x |
| 001. | 1 | 250 | | | 0.0613 | 6.730 | 150 | 1.6 | x | x | x | x | x | x | x | x | x |
| 1.25 | 1.25 | 250 | | 0.0446 | 12.650 | 150 | 1.6 | x | x | x | x | x | x | x | x | x | |
| 01.6 | 1.6 | 250 | | 0.0336 | 23.350 | 150 | 1.6 | x | x | x | x | x | x | x | x | x | |
| 002. | 2 | 250 | | 0.0293 | 14.450 | 150 | 1.6 | x | x | x | x | x | x | x | x | x | |
| 02.5 | 2.5 | 250 | | 0.0219 | 23.250 | 120 | 1.6 | x | x | x | x | x | x | x | x | x | |
| 3.15 | 3.15 | 250 | | 0.0173 | 38.150 | 100 | 1.6 | x | x | x | x | x | x | x | x | x | |
| 004. | 4 | 250 | 40 A @ 250 VAC | 0.0129 | 69.10 | 100 | 1.6 | x | x | x | x | x | x | x | x | x | |
| 005. | 5 | 250 | 50 A @ 250 VAC | 0.0104 | 111.00 | 100 | 1.6 | x | x | x | x | x | x | x | x | x | |
| 06.3 | 6.3 | 250 | 63 A @ 250 VAC | 0.0076 | 198.50 | 100 | 1.6 | x | x | x | x | x | x | x | x | x | |
| 008. | 8 | 250 | 80 A @ 250 VAC | 0.0059 | 341.50 | 100 | 4 | | x | | x | x | x | | x | x | |
| 010. | 10 | 250 | 100 A @ 250 VAC | 0.0045 | 568.00 | 100 | 4 | | x | | x | x | x | | x | x | |
| 12.5 | 12.5 | 250 | 63 A @ 250 VAC | 0.0034 | 889.00 | 100 | 4 | | | | x | x | | | x | | |
| 015. | 15 | 250 | 100 A @ 250 VAC | 0.0028 | 1405.00 | 100 | 4 | | | | x | x | x | | x | x* | |
| 016. | 16 | 250 | 63 A @ 250 VAC | 0.0021 | 1955.00 | 100 | 4 | | | | x | | | | x | | |

* Approval for cartridge versions only

Temperature Re-rating Curve

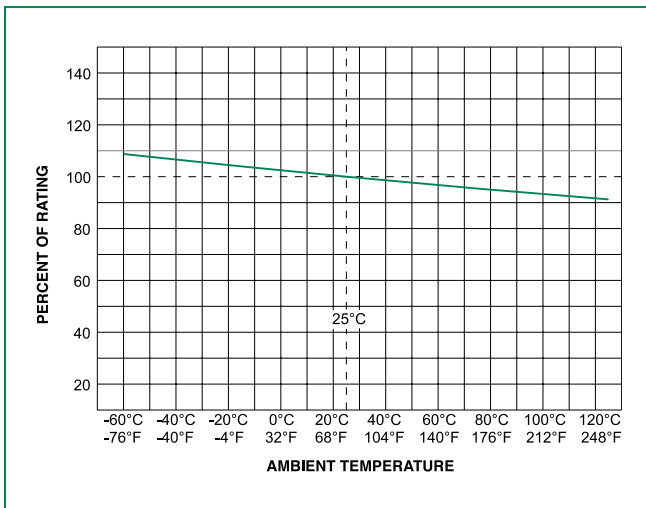

Note:
Re-rating depicted in this curve is in addition to the standard derating of 25% for continuous operation.

Average Time Current Curves

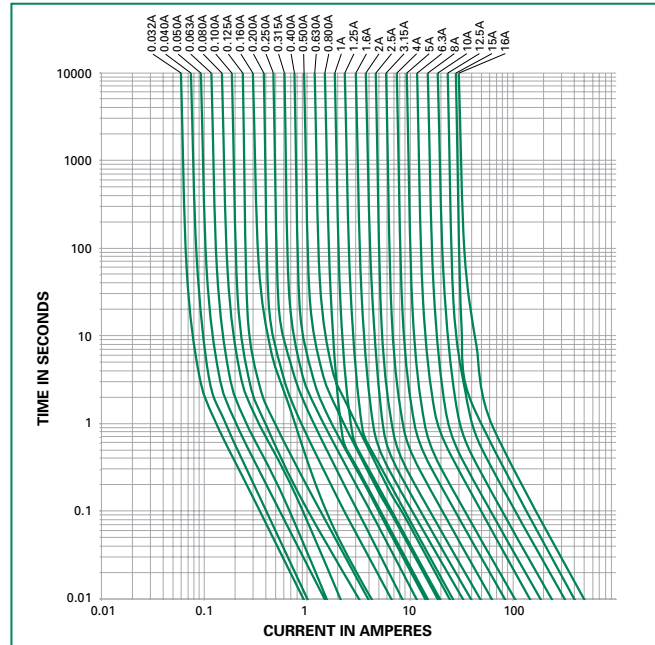

Soldering Parameters - Wave Soldering

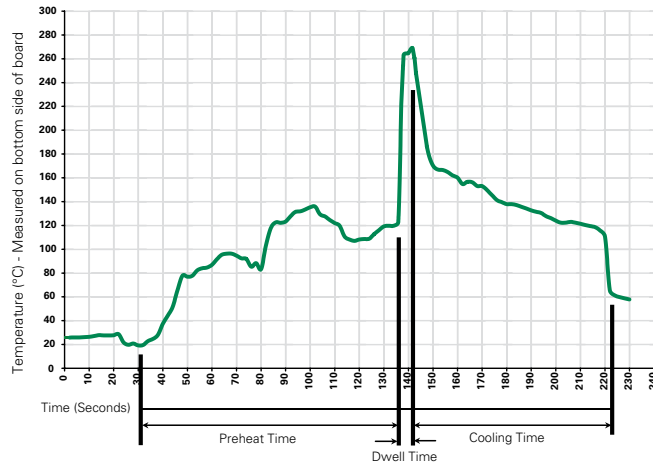

Recommended Process Parameters:

| Wave Parameter | Lead-Free Recommendation |
|---|-----------------------------------|
| Preheat: (Depends on Flux Activation Temperature) | (Typical Industry Recommendation) |
| Temperature Minimum: | 100°C |
| Temperature Maximum: | 150°C |
| Preheat Time: | 60-180 seconds |
| Solder Pot Temperature: | 260°C Maximum |
| Solder Dwell Time: | 2-5 seconds |

Recommended Hand-Solder Parameters:

Solder Iron Temperature: 350°C +/- 5°C
 Heating Time: 5 seconds max.

Note: These devices are not recommended for IR or Convection Reflow process.

Product Characteristics

| | |
|--------------------------|--|
| Material | Body: Glass Cap: Nickel-plated Brass Leads: Tin-plated Copper |
| Terminal Strength | MIL-STD-202, Method 211, Test Condition A |
| Solderability | MIL-STD-202, Method 208 |
| Product Marking | Cap1: Brand logo, current and voltage ratings Cap2: Agency approval marks |
| Packaging | Available in Bulk (M=1000 pcs/pkg) or on Tape/Reel (MRET1=1000 pcs/reel) |

| | |
|------------------------------|---|
| Operating Temperature | -55°C to +125°C |
| Thermal Shock | MIL-STD-202, Method 107, Test Condition B (5 cycles, -65°C to +125°C) |
| Vibration | MIL-STD-202, Method 201 |
| Humidity | MIL-STD-202, Method 103, Test Condition A (High RH (95%) and elevated temperature (40°C) for 240 hours) |
| Salt Spray | MIL-STD-202, Method 101, Test Condition B |

Dimensions

0218 000P

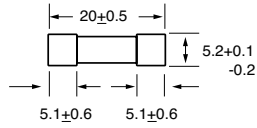

0218.032 XEP
to
0218.100XEP

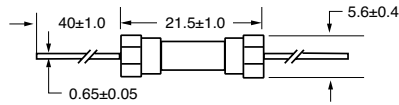

0218.125 XEP
to
0218016. XEP

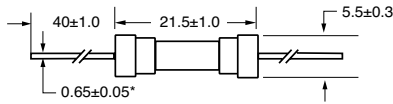

All dimensions in mm

Notes:

* Ratings above 6.3A have 0.8±0.05 diameter lead.

Part Numbering System

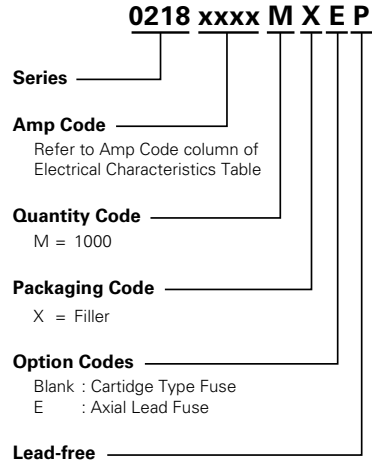

Packaging

| Packaging Option | Packaging Specification | Quantity | Quantity & Packaging Code | Taping Width |
|-------------------|-------------------------|----------|---------------------------|------------------|
| 218 Series | | | | |
| Bulk | N/A | 1000 | MX | N/A |
| Bulk | N/A | 1000 | MXE | N/A |
| Reel and Tape | EIA 296-E | 1000 | MRET1 | T1=53mm (2.087") |
| Bulk | N/A | 1000 | MXG | N/A |
| Bulk | N/A | 1000 | MXB | N/A |
| Bulk | N/A | 100 | HX | N/A |

Recommended Accessories

| Accessory Type | Series | Description | Max Application Voltage | Max Application Amperage |
|----------------|-------------------------|---|-------------------------|--------------------------|
| Holder | 345_ISF | Panel Mount Shock-Safe Fuseholder | 250 | 10 |
| | 345 | Shock-Safe Fuseholder with PC Mount, Solder Mount and Panel Mount options | | 20 |
| | 830 | PC Mount Shock-Safe Miniature Fuseholder | | 16 |
| Block | 520 | Metric OMNI-BLOK® Fuse Block | | 10 |
| | 646 | PC Mount Miniature Fuse Block | | 6.3 |
| | 658 | Surface Mount Miniature Fuse Block | | 10 |
| Clip | 520_W | PC Mount Miniature Fuse Clip | | 6.3 |
| | 111 | PC Board Mount Fuse Clip | | 10 |
| | 445 | PC Board Mount Fuse Clip | | 10 |

Notes:

- Do not use in applications above rating.
- Please refer to fuseholder data sheet for specific re-rating information.
- Please contact factory for applications greater than the max voltage and amperage shown.

Disclaimer Notice - Information furnished is believed to be accurate and reliable. However, users should independently evaluate the suitability of and test each product selected for their own applications. Littelfuse products are not designed for, and may not be used in, all applications. Read complete Disclaimer Notice at: www.littelfuse.com/disclaimer-electronics.