

PLEASE CHECK WWW.MOLEX.COM FOR LATEST PART INFORMATION

Part Number: [0050361744](#)
Status: **Active**
Overview: [minifit_jr](#)
Description: 4.20mm (.165") Pitch Mini-Fit Jr.™ Header, Dual Row, Right Angle, with PCB Mounting Pegs, 8 Circuits, PA Polyamide Nylon 6/6, 94V-0, Bright Tin (Sn) over Nickel (Ni) Plating, Glow Wire Compatible

Documents:

[3D Model](#) [Product Specification PS-5556-001 \(PDF\)](#)
[Drawing \(PDF\)](#) [RoHS Certificate of Compliance \(PDF\)](#)

Agency Certification

CSA	LR19980
TUV	R72081037
UL	E29179

General

Product Family	PCB Headers
Series	5569
Application	Wire-to-Board
Comments	Current = 13A max. per circuit when header is mated to a receptacle loaded with 45750 Mini-Fit Plus HCS™ Crimp Terminal Crimped to to 16 AWG wire. . See Molex Product specification PS-5556-001 for additional current de-rating information.

Overview [minifit_jr](#)
Product Name Mini-Fit Jr.™

Physical

Breakaway	No
Circuits (Loaded)	8
Circuits (maximum)	8
Circuits Detail	8
Color - Resin	Black
Durability (mating cycles max)	30
First Mate / Last Break	No
Flammability	94V-0
Glow-Wire Compliant	Yes
Guide to Mating Part	No
Keying to Mating Part	None
Lock to Mating Part	Yes
Material - Metal	Brass
Material - Plating Mating	Nickel
Material - Plating Termination	Tin
Material - Resin	Nylon
Number of Rows	2
Orientation	Right Angle
PC Tail Length (in)	0.142 In
PC Tail Length (mm)	3.60 mm
PCB Locator	Yes
PCB Retention	Yes
PCB Thickness Recommended (in)	0.070 In
PCB Thickness Recommended (mm)	1.78 mm
Packaging Type	Bag
Pitch - Mating Interface (in)	0.165 In
Pitch - Mating Interface (mm)	4.20 mm

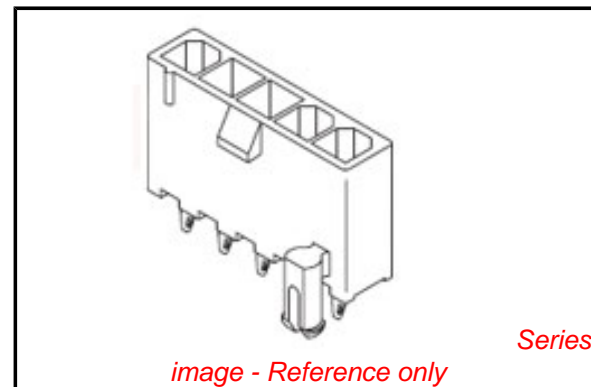

EU RoHS

ELV and RoHS Compliant
REACH SVHC Contains SVHC: No
Halogen-Free Status
Not Reviewed

China RoHS



Need more information on product environmental compliance?

Email productcompliance@molex.com
For a multiple part number RoHS Certificate of Compliance, [click here](#)

Please visit the [Contact Us](#) section for any non-product compliance questions.

Search Parts in this Series

[5569Series](#)

Mates With

[5557](#) Mini-Fit Jr.™ Receptacle

Pitch - Term. Interface (in)	0.165 In
Pitch - Term. Interface (mm)	4.20 mm
Plating min: Mating (µin)	50
Plating min: Mating (µm)	1.27
Plating min: Termination (µin)	100
Plating min: Termination (µm)	2.54
Polarized to Mating Part	Yes
Polarized to PCB	Yes
Shrouded	Fully
Stackable	No
Surface Mount Compatible (SMC)	No
Temperature Range - Operating	-40°C to +105°C
Termination Interface: Style	Through Hole

Electrical

Current - Maximum per Contact	13A
Voltage - Maximum	600V

Solder Process Data

Duration at Max. Process Temperature (seconds)	5
Lead-free Process Capability	Wave Capable (TH only)
Max. Cycles at Max. Process Temperature	1
Process Temperature max. C	235

Material Info

Old Part Number	5569-08A2S-225
-----------------	----------------

Reference - Drawing Numbers

Packaging Specification	PK-5569-002
Product Specification	PS-5556-001
Sales Drawing	SD-5569-NA2*-225
Test Summary	TS-5556-002

This document was generated on 05/21/2010

PLEASE CHECK WWW.MOLEX.COM FOR LATEST PART INFORMATION

LEGEND:

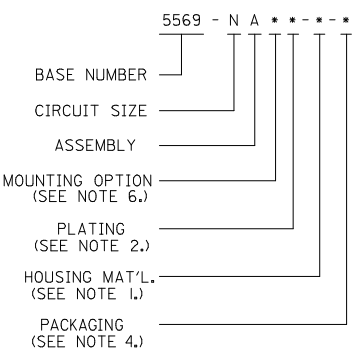

CIRCUIT SIZE	DIM. "A"	DIM. "B"
6	.54 (13.8)	.33 (8.4)
8	.71 (18.0)	.50 (12.6)
10	.87 (22.2)	.66 (16.8)
12	1.04 (26.4)	.83 (21.0)
14	1.20 (30.6)	.99 (25.2)
16	1.37 (34.8)	1.16 (29.4)
18	1.54 (39.0)	1.32 (33.6)
20	1.70 (43.2)	1.49 (37.8)
22	1.87 (47.4)	1.65 (42.0)
24	2.03 (51.6)	1.82 (46.2)

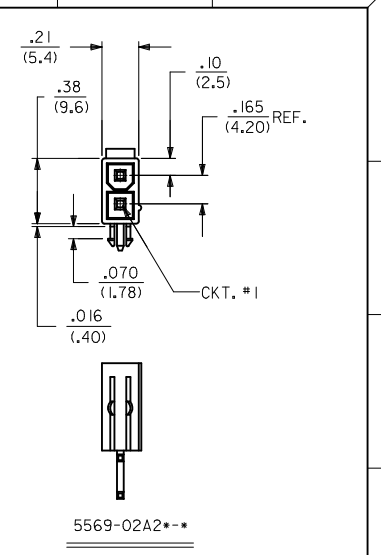
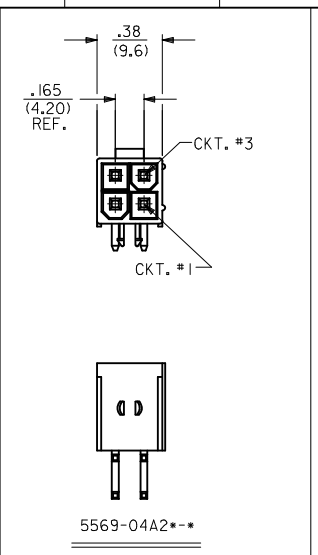
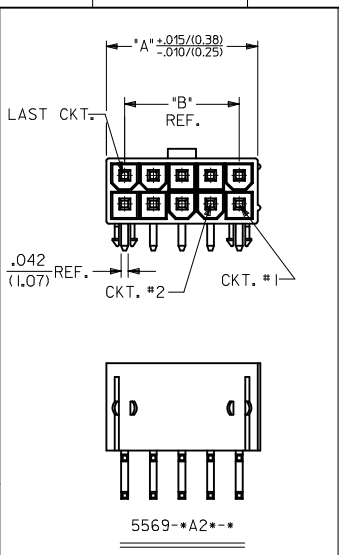
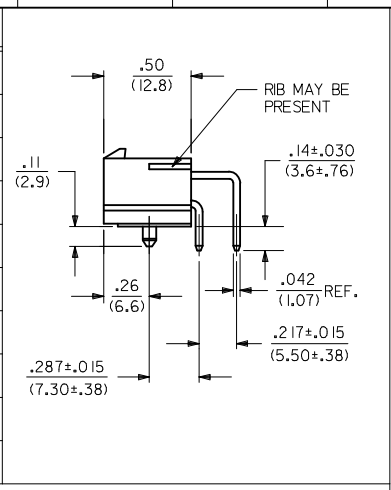

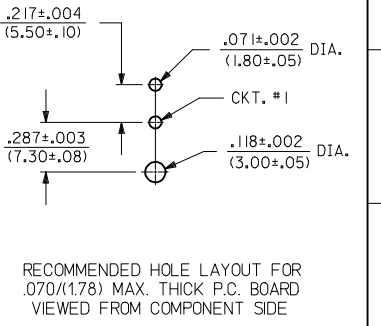
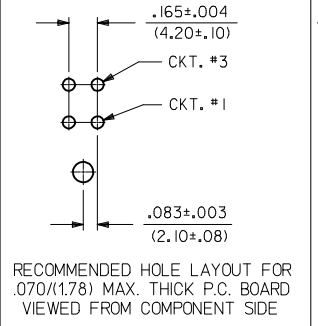
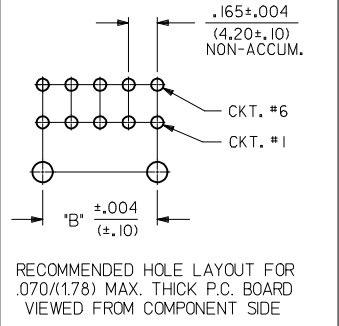

NOTES:

- MATERIAL:
 - HOUSING:
 - *225 = UNFILLED NYLON 6, UL94V-0, IEC 60335-1, 4TH EDITION GLOW WIRE CAPABLE, COLOR - BLACK.
 - TERMINAL:
 - BRASS ALLOY
- FINISH (PLATING):
 - *G = .000030/(0.00076) MIN. GOLD OVER .000050/(0.00127) MIN. NICKEL
 - *G2 = .000015/(0.00038) MIN. GOLD OVER .000030/(0.00076) MIN. NICKEL
 - *G3 = .000050/(0.00127) MIN. GOLD OVER .000050/(0.00127) MIN. NICKEL
 - *GS = .000030/(0.00076) MIN. SELECT GOLD OVER .000100/(0.00254) MIN. SELECT MATTE TIN OVER .000050/(0.00127) MIN. NICKEL OVERALL
 - *GS2 = .000015/(0.00038) MIN. SELECT GOLD OVER .000100/(0.00254) MIN. SELECT MATTE TIN OVER .000050/(0.00127) MIN. NICKEL OVERALL
 - *GS3 = .000050/(0.00127) MIN. SELECT GOLD OVER .000100/(0.00254) MIN. SELECT MATTE TIN OVER .000050/(0.00127) MIN. NICKEL OVERALL
 - *S = .000100/(0.00254) MIN. BRIGHT TIN OVER .000050/(0.00127) MIN. NICKEL
- PRODUCT SPECIFICATION: PS-5569-001
- PACKAGING:
 - *BLANK = BULK PACKED PER PK-5569-002
 - *T = TRAY PACKED PER PK-5569-003
- PART MATES WITH MINI-FIT JR. RECEPTACLE SERIES 5557.
- MOUNTING OPTIONS:
 - 2 = PEG MOUNT
- DISCOLORATION IN THE BANDOLIER CARRIER AREA OF THE PIN IS INHERENT TO THE PLATING PROCESS AND IS DUE TO THE MASKING EFFECT OF THE CARRIER. THIS DISCOLORATION IS IN A NON-FUNCTIONAL AREA OF THE PIN AND WILL NOT AFFECT THE PERFORMANCE OF THE HEADER ASSEMBLY.
- PART CONFORMS TO CLASS "B" REQUIREMENTS OF COSMETIC SPECIFICATION PS-45499-002.
- CONNECTORS ARE NOT TO BE MATED AND UNMATED WHILE CIRCUITS ARE LIVE.
- PARTS ARE NOT DESIGNED FOR CURRENT SHARING.



RELEASE 50362375 IEC NO: UCP2009-1486 DRW: JALOSTER/ER 2008/12/19 CHKD: JBEL 2008/12/22 APPR: FSMITH 2009/01/05	QUALITY SYMBOLS ▽=0 ▽=0	GENERAL TOLERANCES (UNLESS SPECIFIED)		DIMENSION STYLE IN/MM		SCALE 1:1	DESIGN UNITS METRIC	THIRD ANGLE PROJECTION		
		mm INCH		DRAWN BY GAVERRILL	DATE 2008/07/23	TITLE MINI-FIT JR RIGHT ANGLE HEADER ASSEMBLIES WITH MOUNTING PEGS				
		4 PLACES ± --- ± --- 3 PLACES ± --- ± .010 2 PLACES ± .25 ± .015 1 PLACE ± .38 ± ---		CHECKED BY SSOUSEK	DATE 2008/07/23	MOLEX INCORPORATED				
		ANGULAR ±1/2°		APPROVED BY FSMITH	DATE 2008/07/23	DOCUMENT NO. SD-5569-NA2*-225		SHEET NO. 1 OF 2		
DRAFT WHERE APPLICABLE MUST REMAIN WITHIN DIMENSIONS		SEE CHART		THIS DRAWING CONTAINS INFORMATION THAT IS PROPRIETARY TO MOLEX INCORPORATED AND SHOULD NOT BE USED WITHOUT WRITTEN PERMISSION						

13	12	11	10	9	8	7	6	5	4	3	2	1
TOOLED	PART NO.	ENG. NO.	CKT. SIZE	MOUNTING OPTION	PLATING (SEE NOTE 2)	HOUSING MATERIAL (SEE NOTE 1)	PACKAGING					
YES	50-36-2375	5569-02A2S-225	2	PEGS	TIN/NICKEL	94V-0	BULK PACKAGED PER PK-5569-002					
YES	50-36-2306	5569-04A2S-225	4	PEGS	TIN/NICKEL	94V-0						
YES	50-36-2377	5569-06A2S-225	6	PEGS	TIN/NICKEL	94V-0						
YES	50-36-1744	5569-08A2S-225	8	PEGS	TIN/NICKEL	94V-0						
NO	50-36-2294	5569-10A2S-225	10	PEGS	TIN/NICKEL	94V-0						
YES	50-36-2317	5569-12A2S-225	12	PEGS	TIN/NICKEL	94V-0						
	50-36-2298	5569-14A2S-225	14	PEGS	TIN/NICKEL	94V-0						
NO	NOT ASSIGNED	5569-16A2S-225	16	PEGS	TIN/NICKEL	94V-0						
	NOT ASSIGNED	5569-18A2S-225	18	PEGS	TIN/NICKEL	94V-0						
	NOT ASSIGNED	5569-20A2S-225	20	PEGS	TIN/NICKEL	94V-0						
	NOT ASSIGNED	5569-22A2S-225	22	PEGS	TIN/NICKEL	94V-0						
	NOT ASSIGNED	5569-24A2S-225	24	PEGS	TIN/NICKEL	94V-0						

RELEASE 50362375 EC NO: UCP2009-1486 DRWN:JKLOSTEMEIER 2008/12/19 CHKD:JBELL 2008/12/22 APPR:FSMITH 2009/01/05	QUALITY SYMBOLS  =0  =0	GENERAL TOLERANCES (UNLESS SPECIFIED)		DIMENSION STYLE IN/MM		SCALE 1:1	DESIGN UNITS METRIC	THIRD ANGLE PROJECTION			
				mm	INCH	DRAWN BY GAVERILL	DATE 2008/07/23	MINI-FIT JR RIGHT ANGLE HEADER ASSEMBLIES WITH MOUNTING PEGS			
		4 PLACES ± --- ± ---				CHECKED BY SSOUSEK	DATE 2008/07/23				
		3 PLACES ± --- ±.010				APPROVED BY FSMITH	DATE 2008/07/23				
2 PLACES ±.25 ±.015				MATERIAL NO. SEE CHART		DOCUMENT NO. SD-5569-NA2*-225		SHEET NO. 2 OF 2			
1 PLACE ±.38 ± ---		ANGULAR ±1/2°		DRAFT WHERE APPLICABLE MUST REMAIN WITHIN DIMENSIONS		THIS DRAWING CONTAINS INFORMATION THAT IS PROPRIETARY TO MOLEX INCORPORATED AND SHOULD NOT BE USED WITHOUT WRITTEN PERMISSION					