

Solid State Relays

G3RV-C1D2

Slimmest Industrial Plug-in SSR for Use in Class I Division 2 Hazardous Areas

- Rated UL Class I Div 2 for use in hazardous environments
- Save panel space: Measures just 6.2 mm wide, allows gang mounting of 8 relays for a compact output block
- Direct connection with PLC adapter and pre-terminated cables to Omron PLCs and slice I/O
- Long electrical life and high speed switching
- G3RV Socket - Robust plug-in terminals for reliable connection
- G3RV-D (DC load) models can manage resistive loads of 100 μ A to 3.0 A
- Monitor operation status with built-in LED indicator

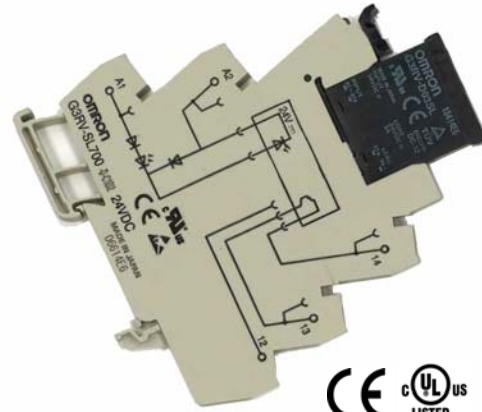

Model Number Structure

Model Number Legend

G3RV-SL -

1 2 3 4 5

- | | |
|---|--|
| <ol style="list-style-type: none"> Basic Model Name
G3RV: Solid State Relay Auxiliary Type Designation
SL: Slim Solid State Relay and socket combination Wire Connection
700: Screw Terminals
500: Spring Terminals | <ol style="list-style-type: none"> Output voltage specifications
A(L): AC Output...TRIAC
 * A: with Zero cross function AL: without Zero cross function
D: DC Output...MOS FET Special UL Rating
C1CD2: Class 1 Div 2 |
|---|--|

Class I, Division 2 Rating

Use in Hazardous Environments

Products with this rating are not capable of causing an ignition within a specified flammable gasses or vapor-air mixture due to arcing.

One of the following three situations must exist in order for an area to be considered a Class I, Division 2 location.

- An area where flammable liquids and gases are handled, but not expected to be in explosive concentrations. However, the possibility for these concentrations to exist might occur if there was an accidental rupture or other unexpected incident.
- An area where ignitable gases or vapors are normally prevented from accumulating by positive mechanical ventilation, yet could exist in ignitable quantities if there was a failure in the ventilation systems.
- Areas adjacent to Class I, Division 1 locations where the atmosphere is expected to contain explosive mixtures of gases, vapors, or liquids during normal working operations. It is possible for ignitable concentrations of gas/vapors to come into the Class I, Division 2 area if there is not proper ventilation.



Ordering Information

■ List of Models

SSR and Socket Combinations

Input Voltage	Screw Termination Model Number	Spring Termination Model Number
12 VDC	G3RV-SL700-D-C1D2 DC12	G3RV-SL500-D-C1D2 DC12
	G3RV-SL700-A-C1D2 DC12	G3RV-SL500-A-C1D2 DC12
	G3RV-SL700-AL-C1D2 DC12	G3RV-SL500-AL-C1D2 DC12
24 VDC	G3RV-SL700-D-C1D2 DC24	G3RV-SL500-D-C1D2 DC24
	G3RV-SL700-A-C1D2 DC24	G3RV-SL500-A-C1D2 DC24
	G3RV-SL700-AL-C1D2 DC24	G3RV-SL500-AL-C1D2 DC24
24 VAC/DC	G3RV-SL700-D-C1D2 AC/DC24	G3RV-SL500-D-C1D2 AC/DC24
	G3RV-SL700-A-C1D2 AC/DC24	G3RV-SL500-A-C1D2 AC/DC24
	G3RV-SL700-AL-C1D2 AC/DC24	G3RV-SL500-AL-C1D2 AC/DC24
48 VAC/DC	G3RV-SL700-D-C1D2 AC/DC48	G3RV-SL500-D-C1D2 AC/DC48
	G3RV-SL700-A-C1D2 AC/DC48	G3RV-SL500-A-C1D2 AC/DC48
	G3RV-SL700-AL-C1D2 AC/DC48	G3RV-SL500-AL-C1D2 AC/DC48
110 VAC	G3RV-SL700-D-C1D2 AC110	G3RV-SL500-D-C1D2 AC110
	G3RV-SL700-A-C1D2 AC110	G3RV-SL500-A-C1D2 AC110
	G3RV-SL700-AL-C1D2 AC110	G3RV-SL500-AL-C1D2 AC110
230 VAC	G3RV-SL700-D-C1D2 AC230	G3RV-SL500-D-C1D2 AC230
	G3RV-SL700-A-C1D2 AC230	G3RV-SL500-A-C1D2 AC230
	G3RV-SL700-AL-C1D2 AC230	G3RV-SL500-AL-C1D2 AC230

Replacement SSR

Classification		Enclosure rating	Input voltage	Contact form	Type of connection	Model number
Plug-in terminals	General-purpose	Unsealed	AC/DC	SPST	Screw terminals	G3RV-SL700
					Spring terminals	G3RV-SL500

■ Accessories

PLC Interface Unit

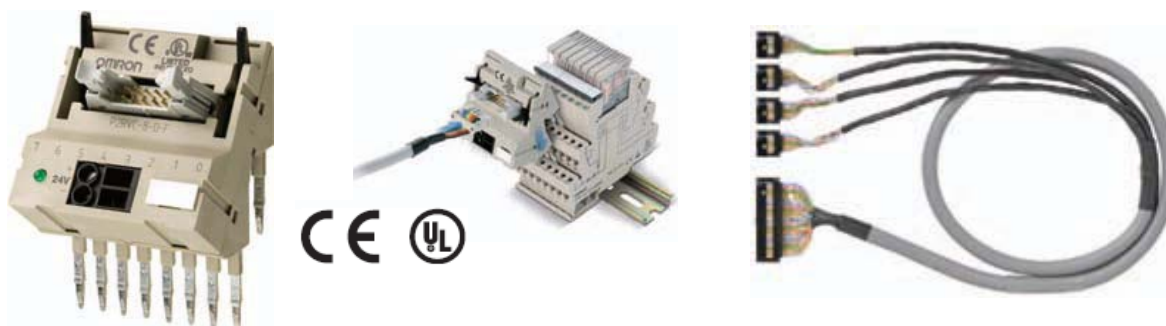

Description	Connection	Model number
PLC Output Interface for 8x G2RV-SL700 series relays; PNP type	Ribbon cable connector 10 pole, IEC603/1	P2RVC-8-O-F

Cables for PLC Interface

Compatible units	Connectors	Cable length	Model number
CJ1 output units-MIL connectors: CJ1W-OD232, CJ1W-OD262	MIL10-MIL40	1.0 m	P2RV-4-100C
		2.0 m	P2RV-4-200C
		3.0 m	P2RV-4-300C
		5.0 m	P2RV-4-500C
Universal output units	MIL10-Flying leads	1.0 m	P2RV-4-A100C
		2.0 m	P2RV-4-A200C
		3.0 m	P2RV-4-A300C
		5.0 m	P2RV-4-A500C
NX Slice I/O series output units: NX-OD2258, NX-OD3256, NX-OD3257, NX-OD4256, NX-OD5256	MIL10-XW7F 16-pole	0.5 m	P2RV-A050C-OMR NX
		1.0 m	P2RV-A100C-OMR NX
GRT1 Slice I/O series output units: GRT1-OD4-1, GRT1-OD4G-1, GRT1-OD4G-3, GRT1-OD8-1, GRT1-OD8G-1	MIL10-XW7F 12-pole	0.5 m	P2RV-A050C-OMR GRT1
		1.0 m	P2RV-A100C-OMR GRT1

Cross Bars

Specifications

Item	Remarks	Rating
Max. current	EN60947-7-1 section 8.3.3/1991	32 A
Max. voltage	--	400 VAC
	When cutting cross bar without using a separation plate or end bracket	250 VAC



Number of Poles	Model number		
	Red	Blue	Black
2	P2RVM-020R	P2RVM-020S	P2RVM-020B
3	P2RVM-030R	P2RVM-030S	P2RVM-030B
4	P2RVM-040R	P2RVM-040S	P2RVM-040B
10	P2RVM-100R	P2RVM-100S	P2RVM-100B
20	P2RVM-200R	P2RVM-200S	P2RVM-200B

Labels (Stickers) for G2RV/G3RV Sockets

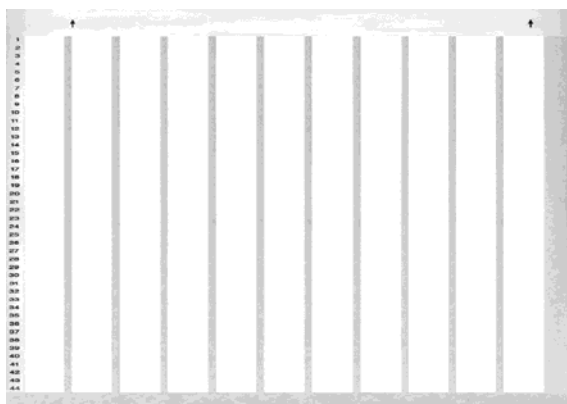

Color	Box quantity	Model number
White	1 piece = 1 sheet = 484 labels (stickers)	R99-16 for G2RV

Plastic Labels for G2RV/G3RV Sockets

Color	Box quantity	Model number
White	5 sheets x 120 labels = 600 labels (minimum order)	R99-15 for G2RV



Separating Plate

Description	Model number
Plate provides isolation between adjacent relays to achieve 400 V isolation.	P2RV-S

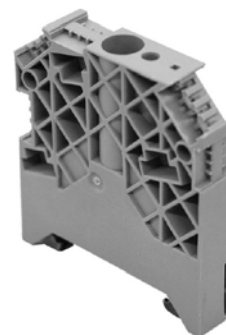

Specifications

■ Ratings (at an Ambient Temperature of 25°C)

Input

G3RV-SL700/500-A Series

Rated voltage	Rated current			Must operate voltage	Must release voltage	Input voltage
	AC		DC			% of rated voltage
	50 Hz	60 Hz				
12 VDC	--	--	15 mA	10.8 V	1 V	±10%
24 VDC	--	--	12 mA	21.6 V		
24 VAC/DC	20 mA	21 mA	11 mA	21.6 V		
48 VAC/DC	10 mA	11 mA	6 mA	43.2 V		
110 VAC	7.5 mA	8.2 mA	--	99 V		
230 VAC	7.3 mA	8.6 mA	--	207 V		

G3RV-SL700/500-AL Series

Rated voltage	Rated current			Must operate voltage	Must release voltage	Input voltage
	AC		DC			% of rated voltage
	50 Hz	60 Hz				
12 VDC	--	--	15 mA	10.8 V	1 V	±10%
24 VDC	--	--	12 mA	21.6 V		
24 VAC/DC	20 mA	21 mA	11 mA	21.6 V		
48 VAC/DC	10 mA	11 mA	6 mA	43.2 V		
110 VAC	7.5 mA	8.2 mA	--	99 V		
230 VAC	7.3 mA	8.6 mA	--	207 V		

G3RV-SL700/500-D Series

Rated voltage	Rated current			Must operate voltage	Must release voltage	Input voltage
	AC		DC			% of rated voltage
	50 Hz	60 Hz				
12 VDC	--	--	8 mA	10.8 V	1 V	±10%
24 VDC	--	--	4.5 mA	21.6 V		
24 VAC/DC	10.7 mA	11.1 mA	4.3 mA	21.6 V		
48 VAC/DC	9.6 mA	10.2 mA	6 mA	43.2 V		
110 VAC	6.8 mA	7.5 mA	--	99 V		
230 VAC	6.8 mA	8.1 mA	--	207 V		

Output

Item	G3RV-SL700/500-A(L)	G3RV-SL700/500-D
Rated load voltage	100 to 240 VAC, 50/60 Hz	5 to 24 VDC
Load voltage range	75 to 264 VAC, 50/60 Hz	3 to 26.5 VDC
Load current	0.1 to 2 A (Ta=40°C)	100 µA to 3 A (Ta=40°C)
Inrush current	30 A (60 Hz/1 cycle)	30 A (60 Hz/1 cycle)
Permissible I ² t; Joule Integral (Reference value)	15 A ² s	9 A ² s
Application load capacity	400 W (Output voltage: 200 VAC)	72 W (Output voltage: 24 VDC)

■ Characteristics

Item	G3RV-SL700/500-A	G3RV-SL700/500-AL	G3RV-SL700/500-D
Operate time	½ of load power source cycle + 1 ms max.	1 ms max.	6 ms max.
Release time	40 ms max.	20 ms max.	60 ms max.
Output ON voltage drop	1.6 V rms max.		0.9 V max.
Leakage current	5 mA max. (at 200 VAC 50/60Hz)		10 µA max. (at 24 VDC)
Insulation resistance	100 MΩ min. (at 500 VDC)		
Dielectric strength	2500VAC, 50/60 Hz for 1 minute between input and output		
Vibration resistance	Malfunction: 10 to 55 to 10 Hz, 0.7-mm single amplitude		
Shock resistance	300 m/s ²		
Ambient temperature	Storage: -30~+100°C (with no icing or condensation) Operating: -30~+55°C (with no icing or condensation)		
Ambient humidity	45~85% RH		
Weight	Approx. 38 g		
Pollution degree	2		
Degree of protection according to IEC 60529	IP20		
Rated Impulse Withstand Voltage	4.0kV / III		
Load category	LC-A		DC-12
Overload Current Profile	1.5Ie 1.1Ie 5s ON, 10s OFF, 10 cycles		
Rated insulation Voltage	240		

■ Approved Standards

UL 508 (File No. E64562)

Model	Input ratings	Contact ratings
G3RV-SL700/500-D Series	12, 24 VDC 24, 48 VAC/DC 110, 230 VAC	24 VDC 3 A (Resistive Load) at 25°C
G3RV-SL700/500-A(L) Series	12, 24 VDC 24, 48 VAC/DC 110, 230 VAC	240 VAC 2 A (Resistive Load) at 25°C

IEC/TUV (EN 62314)

Input ratings	Contact ratings
12, 24 VDC 24, 48 VAC/DC 110, 230 VAC	24 VDC 3 A (Resistive Load)
12, 24 VDC 24, 48 VAC/DC 110, 230 VAC	240 VAC 2 A (Resistive Load)

Approved Standards for Class 1 Div 2

ANSI/ISA 12.12.01 (File No. E467446), CSA22.2 No.213 (File No. E467446)

Model	Input Ratings	Contact Ratings
G3RV-SL700/500-D-CD12 Series	12, 24 VDC 24, 48 VAC/DC 110, 230 VAC	5 to 24 VDC 3 A (General use, Resistive load) at 25°C 5 to 24 VDC 2 A (General use, Resistive load) at 55°C
G3RV-SL700/500-A(L)-CD12 Series	12, 24 VDC 24, 48 VAC/DC 110, 230 VAC	100 to 240 VAC 2 A (General use, Resistive load) at 25°C 100 to 240 VAC 1 A (General use, Resistive load) at 55°C

Engineering Data

■ **Load current derating curves**

G3RV-SL700/500-A(L) Series

Mounting Distance 10mm

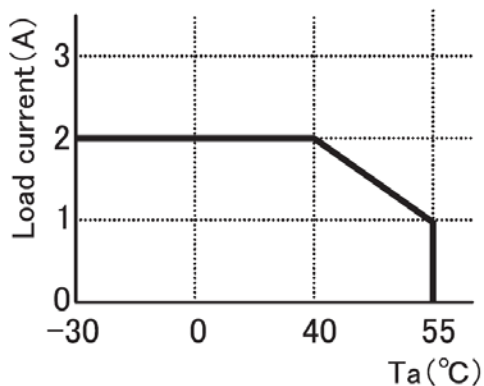

Mounting Distance 0mm

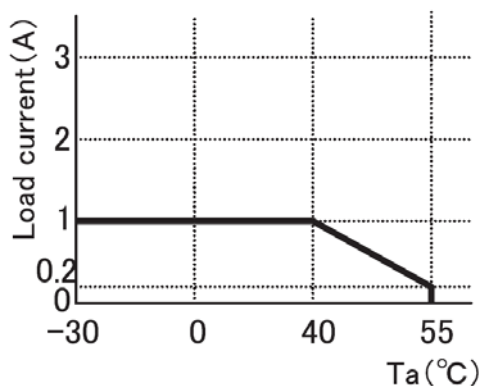

G3RV-SL700/500-D Series

Mounting Distance 10mm

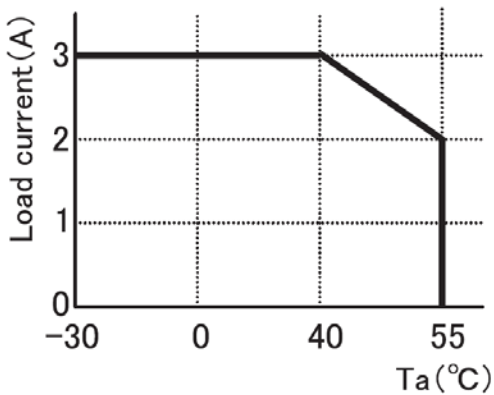

Mounting Distance 0mm

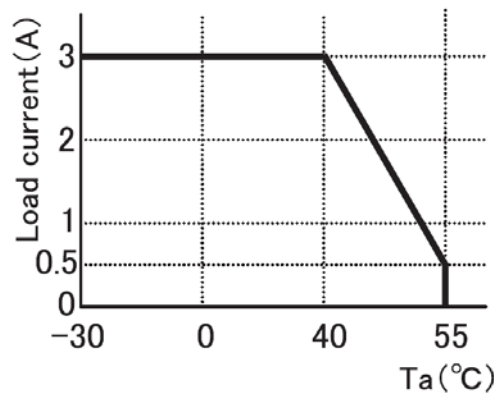

■ One Cycle Surge Current: Non-repetitive

The values shown by the solid line are for non-repetitive inrush currents. Values shown by the broken line are for repetitive inrush currents. Keep the inrush current to half the rated value if it occurs repetitively.

G3RV-SL700/500-A(L) Series

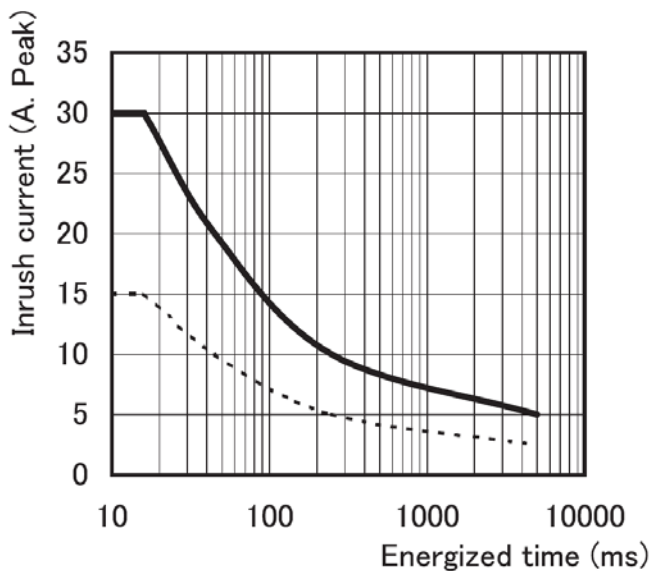

G3RV-SL700/500-D Series

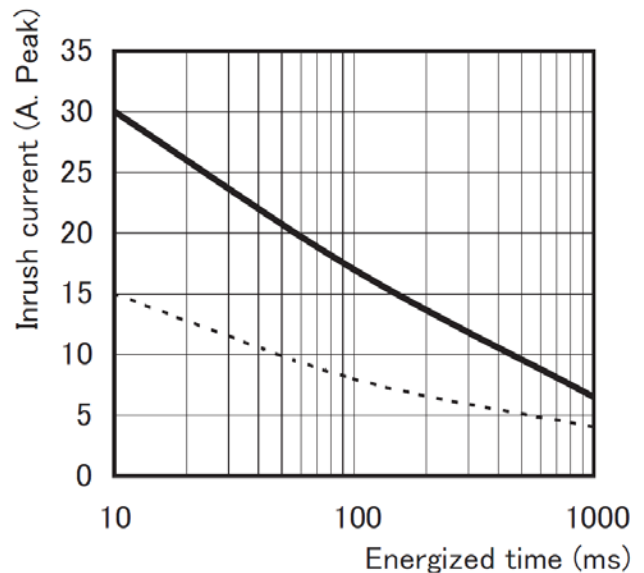

Dimensions

Note: All units are in millimeters unless otherwise indicated.

■ Complete Unit

G3RV-SL700

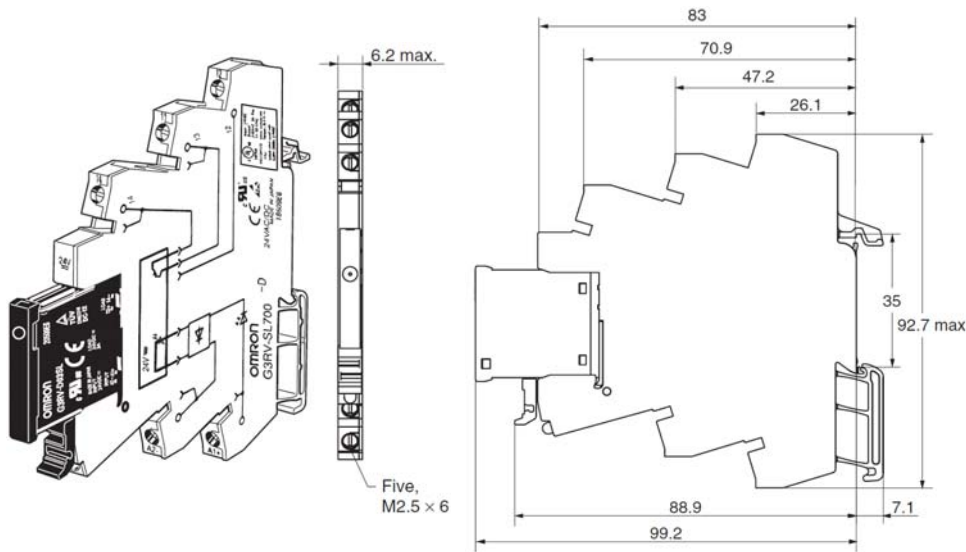

Input circuit

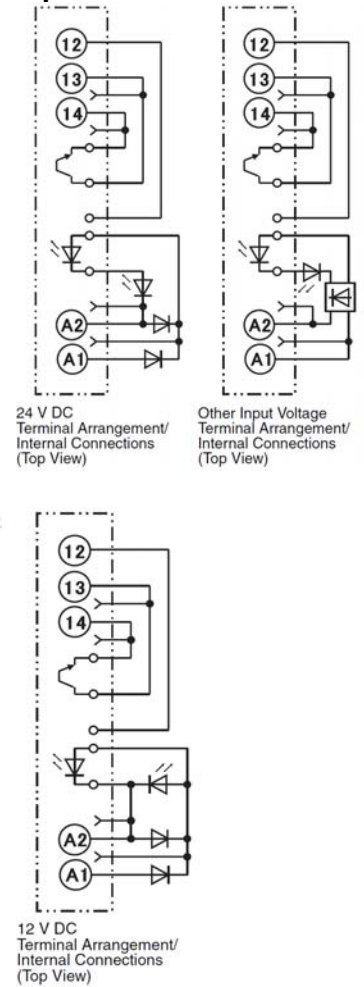

G3RV-SL500

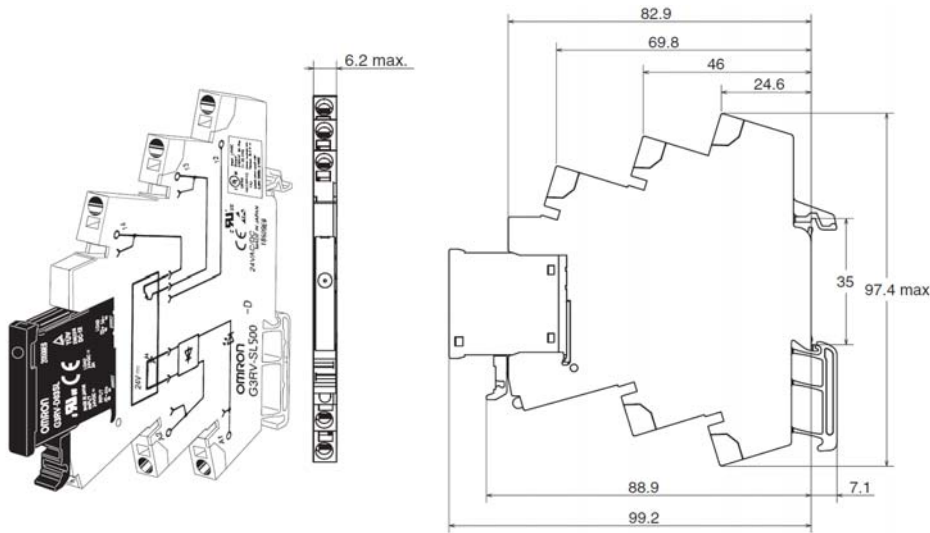

Input circuit

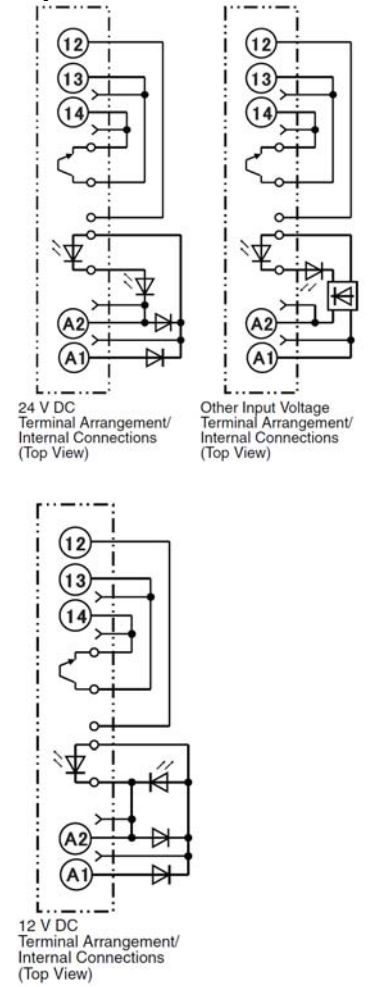

■ **Solid State Relay**

G3RV-D03SL
G3RV-202S(L)

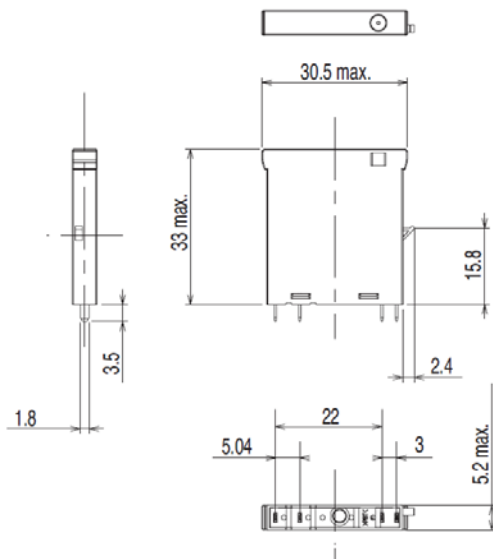

Input Circuit
G3RV-D03SL

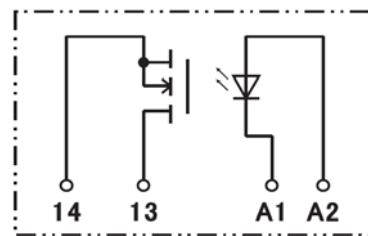

G3RV-202S(L)

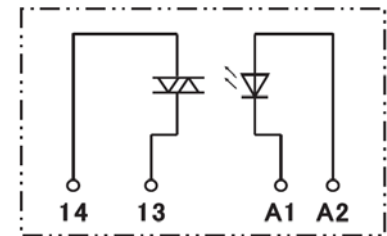

Terminal Arrangement/
Internal Connections
(Bottom View)

Installation

■ Tools

G3RV-SL700 series: Flat-Blade screwdriver should be used for mounting and / or releasing cables.

G3RV-SL500 series: Flat-Blade screwdriver should be used for mounting stranded wires without ferrules and / or releasing cables.

Applicable Screwdriver

- Flat-blade, Parallel-tip, 2.5 mm diameter (3.0 mm max.)

- Flat-blade, Parallel-tip



2.5 dia. (3.0 mm max.)

- Flat-blade, Flared-tip

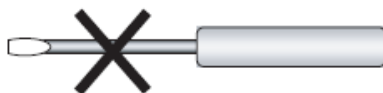

Cannot be used.

Examples: FACOM AEF.2.5 × 75E (AEF. 3 × 75E)
 VESSEL No. 9900-(-)2.5 × 75 (No. 9900-(-)3 × 100)
 WAGO 210-119
 WIHA 260/2.5 × 40 (260/3 × 50)

*Chamfering the tip of the driver improves insertion when used as an exclusive tool.

■ Applicable Wires

Applicable Wire Sizes

G3RV-SL700 Series

Box clamp technology

Wire type	Applicable wire size	Stripping length
Stranded without ferrules	0.5 - 1.5 mm ²	7 mm
Stranded with ferrules and plastic collar	0.5 - 1.5 mm ²	7 mm
Stranded with ferrules without plastic collar	0.5 - 1.5 mm ²	7 mm
Solid	0.5 - 1.5 mm ²	7 mm

G3RV-SL500 Series

Push-in technology

Wire type	Applicable wire size	Stripping length
Stranded without ferrules	0.5 - 1.5 mm ²	12 mm
Stranded with ferrules and plastic collar	0.5 - 1.5 mm ²	12 mm
Stranded with ferrules without plastic collar	0.5 - 1.5 mm ²	12 mm
Solid	0.5 - 1.5 mm ²	12 mm

Tightening torque

G3RV-SL700 Series: 0.4Nm

■ Wiring

Use wires of the applicable sizes specified above. The length of the exposed conductor should be 7 mm for a G3RV-SL700 series, 12 mm for a G3RV-SL500 series.

G3RV-SL700



G3RV-SL500

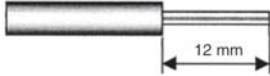
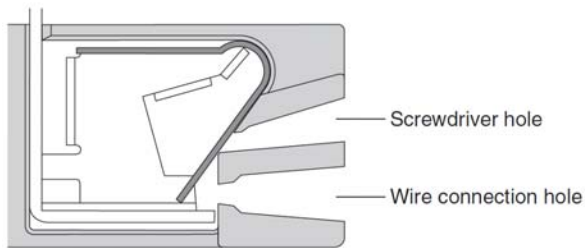
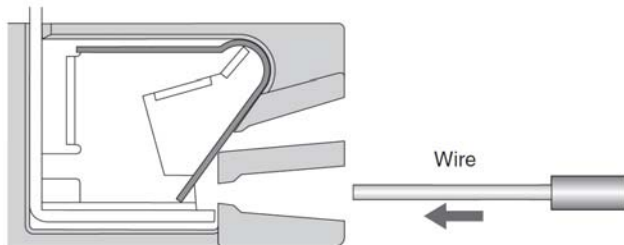

Fig. 1 Exposed Conductor Length

Wiring Procedure for G3RV-SL500 series



● Wiring



Insert the exposed conductor into the connection hole.

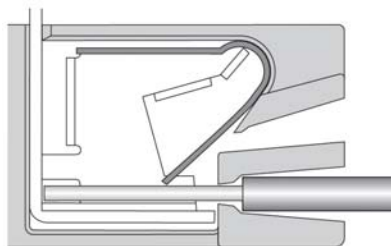

No other tools are required.

Note: In case of wiring stranded wires without ferrules screwdriver should be inserted before inserting the wire.
Screwdriver should be removed after fully inserting the wire.

● Removing

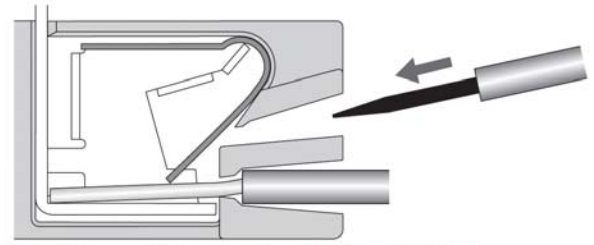

Insert the specified screwdriver into the release hole.

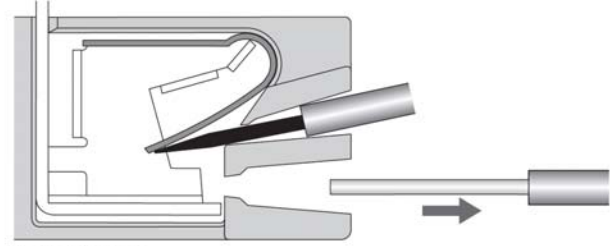

Removing wire.

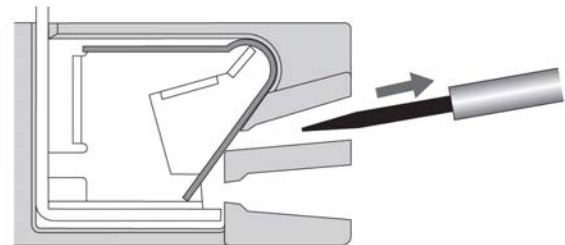

Removing screwdriver.

Precautions

Precautions for Connection

- Do not move the screwdriver up, down, or from side to side while it is inserted in the hole. Doing so may cause damage to internal components (e.g., deformation of the clamp spring or cracks in the housing) or cause deterioration of insulation.
- Do not insert the screwdriver at an angle. Doing so may break the side of socket and result in a short-circuit.

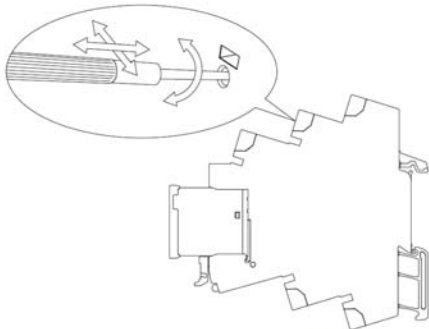

- Do not insert two or more wires in the hole. Wires may come in contact with the spring causing a temperature rise or be subject to sparks.



- Insert the screwdriver along the hole wall as shown below.

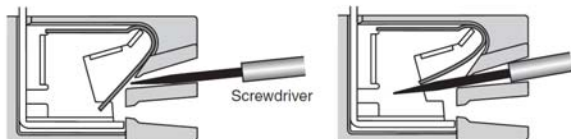

- If lubricating liquid, such as oil, is present on the tip of screwdriver, the screwdriver may fall out resulting in injury to the operator.
- Insert the screwdriver into the bottom of the hole. It may not be possible to connect cables properly if the screwdriver is inserted incorrectly.

General Precautions

- Do not use the product if it has been dropped on the ground. Dropping the product may adversely affect performance.
- Confirm that the socket is securely attached to the mounting track before wiring. If the socket is mounted insecurely it may fall and injure the operator.
- Ensure that the socket is not charged during wiring and maintenance. Not doing so may result in electric shock.
- Do not pour water or cleansing agents on the product. Doing so may result in electric shock.
- Do not use the socket in locations subject to solvents or alkaline chemicals.
- Do not use the socket in locations subject to ultraviolet light (e.g., direct sunlight). Doing so may result in markings fading, rust, corrosion, or resin deterioration.
- Do not dispose the product in fire.

Removing from Mounting Rail



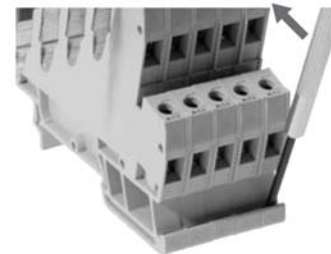

To remove the socket from the mounting rail, insert the tip of screwdriver in the fixture rail, and move it in the direction shown below.



Definition of Precautionary Information

⚠ WARNING	Indicates a potentially hazardous situation which, if not avoided, will result in minor or moderate injury, or may result in serious injury or death. Additionally there may be significant property damage.
------------------	--

⚠ CAUTION	A potentially hazardous situation by misuse, may result in property damage only accident.
------------------	---

⚠ CAUTION	
Minor hazard by electric shock may occasionally occur. Do not touch the G3RV's terminal (Charging part) while the power supply turned on.	
The G3RV may occasionally rupture in case of a short circuit. To protect against short-circuit accident, install a protective device, such as a quick-burning fuse or a circuit breaker or the like, on the power supply.	
Minor hazard by electric shock may occasionally occur. Do not touch the G3RV's main circuit terminals immediately after the power is turned OFF. The internal snubber circuit is charged. * 202S,SL,G3RV-A(L) Type only	
Minor hazard by burns may occasionally occur. Do not touch the G3RV or the heat sink either while the power supply is ON, or immediately after the power is turned OFF. The G3RV and the heat sink will be hot.	

Precautions for Safe Use

● Shipping

When shipping the G3RV, be sure to avoid the following:

- Conditions where the G3RV is exposed to water.
- High ambient temperatures and humidity.
- Inadequate packaging

Failure to avoid these conditions while shipping G3RV will lead to damage, malfunction, or deterioration.

● Operating and Storage Locations

Do not use or store the G3RV in the locations listed below. Failure to do so may result in damage, malfunction, or deterioration of performance characteristics.

- Locations subject to rain or water drops.
- Locations subject to exposure to water, or oil, or chemicals.
- Locations subject to high temperatures or high humidity.
- Locations subject to ambient temperatures outside the range from -30 to +100 centigrade.
- Locations subject to relative humidity outside the range 45% to 85%.
- Locations subject to corrosive or flammable gases.
- Locations subject to dust (especially iron dust) or salts.
- Locations subject to barrier.
- Locations subject to static electricity or other forms of noise.
- Locations subject to strong electromagnetic fields.
- Locations subject to possible exposure to radioactivity.

● Handling

- Be sure to provide adequate air flow to G3RV. Failure to do so can cause the G3RV to overheat leading to short circuit and burning.
- Do not install G3RV Relay with bent terminals into the socket. Doing so could lead to poor electrical connection and hazardous conditions.
- Be sure to mount G3RV's with clean hands. Performing mounting with oil stained hands or coated with metal powder could result in hazardous outcomes.

● Mounting

- Be sure to mount the G3RV in the specified orientation. Mounting the G3RV in a different orientation could lead to abnormal heat generation causing output elements to short leading to burning.
- G3RV's are SSR's and generate heat. Be sure to control ambient temperature in setting where G3RV is used. If mounted in an enclosed space, install a fan to insure G3RV is properly ventilated.
- Be sure that the G3RV clicks into place when mounting it to DIN Track. The G3RV may fall if it is not mounted correctly.

● Wiring

- Use a wire an adequate size for current to be applied. Abnormal heating of wire may cause burning.
- Do not use any wires with damaged sheaths. These may cause electric shock.
- Confirm that wiring to G3RV Socket is not used in pipe or duct for high voltage power supply. Using a wire in pipe or duct connected to high voltage power supply will generate induction causing malfunction or damage.
- Be sure to conduct wiring with the power supply turned OFF. Touching the terminals when they are charged may occasionally result in minor electric shock.

● Using

- Select a load within the rated range. Inappropriate load may cause misoperation, trouble or burning.
- Select the power supply within the rated frequency range. Inappropriate power frequency may cause misoperation, trouble or burning.

Precautions for Correct Use

- G3RV uses electronics parts inside, so that any dropping, vibration, and physical shock beyond the standard level should be prevented. Failure to do so may result in damage, malfunction, or deterioration of performance characteristics.
- Be sure to use tightening torque of 0.4 N·m for screw terminal G3RV. Failure to do so could result in short circuit failure and burning.
- Be sure to use proper voltage/current to G3RV input and output terminals. Failure to do so could result in short circuit failure and burning.

● Mounting

<SSR Mounting Pitch (Panel Mounting)>

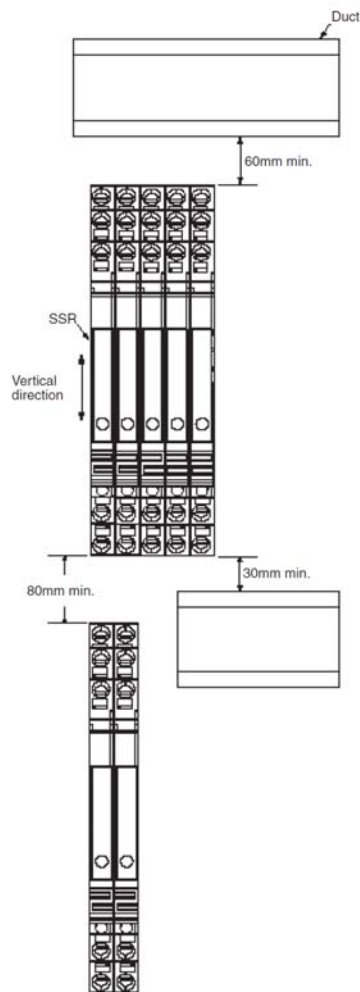

<Relations between SSR and duct (Depth of duct)>

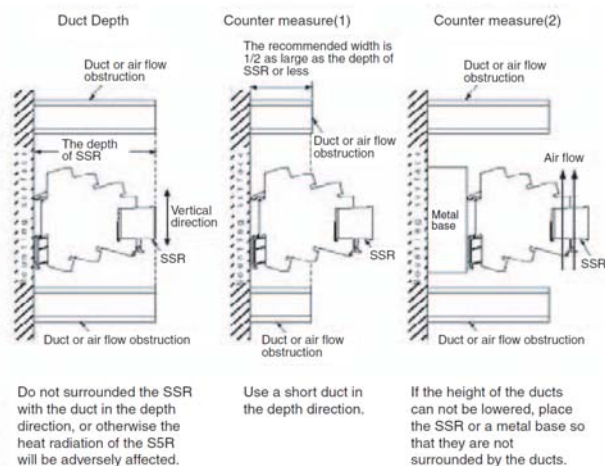

<Ventilation Outside the Control Panel>

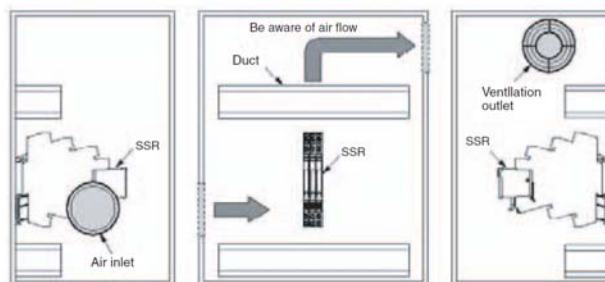

- * If the air inlet or outlet has a filter, clean the filter regularly to prevent it from clogging and ensuring efficient flow of air.
- * Do not locate any objects around the air inlet or air outlet, otherwise the objects may obstruct the proper ventilation of the control panel.
- * A heat exchanger, if used, should be located in front of the G2RVs to ensure the efficiency of the heat exchanger.
- * Please monitor the ambient temperature of the G3RV's. The rated load current is measured at 25°C ambient temperature.
- * A G3RV uses semiconductor in the output element. This causes the temperature inside the control panel to increase due to heating resulting from the passage of electrical current through the load. To restrict heating, attach a fan to the ventilation outlet or air inlet of the control panel to ventilate the panel. This will reduce the ambient temperature of the G3RVs and thus increase reliability. (Generally, each 10°C reduction in temperature will double the expected life.)

● EMI

- This is a class A product. In residential areas it may cause radio interference, in which case the user may be required to take adequate measures to reduce interference.

Suitability for Use

OMRON shall not be responsible for conformity with any standards, codes, or regulations that apply to the combination of the products in the customer's application or use of the product.

Take all necessary steps to determine the suitability of the product for the systems, machines, and equipment with which it will be used.

Know and observe all prohibitions of use applicable to this product.

NEVER USE THE PRODUCTS FOR AN APPLICATION INVOLVING SERIOUS RISK TO LIFE OR PROPERTY WITHOUT ENSURING THAT THE SYSTEM AS A WHOLE HAS BEEN DESIGNED TO ADDRESS THE RISKS, AND THAT THE OMRON PRODUCT IS PROPERLY RATED AND INSTALLED FOR THE INTENDED USE WITHIN THE OVERALL EQUIPMENT OR SYSTEM.

See also Product catalog for Warranty and Limitation of Liability.

ALL DIMENSIONS SHOWN ARE IN MILLIMETERS.
To convert millimeters into inches, multiply by 0.03937. To convert grams into ounces, multiply by 0.03527.

Terms and Conditions of Sale

1. **Offer; Acceptance.** These terms and conditions (these "Terms") are deemed part of all quotes, agreements, purchase orders, acknowledgments, price lists, catalogs, manuals, brochures and other documents, whether electronic or in writing, relating to the sale of products or services (collectively, the "Products") by Omron Electronics LLC and its subsidiary companies ("Omron"). Omron objects to any terms or conditions proposed in Buyer's purchase order or other documents which are inconsistent with, or in addition to, these Terms.
2. **Prices; Payment Terms.** All prices stated are current, subject to change without notice by Omron. Omron reserves the right to increase or decrease prices on any unshipped portions of outstanding orders. Payments for Products are due net 30 days unless otherwise stated in the invoice.
3. **Discounts.** Cash discounts, if any, will apply only on the net amount of invoices sent to Buyer after deducting transportation charges, taxes and duties, and will be allowed only if (i) the invoice is paid according to Omron's payment terms and (ii) Buyer has no past due amounts.
4. **Interest.** Omron, at its option, may charge Buyer 1-1/2% interest per month or the maximum legal rate, whichever is less, on any balance not paid within the stated terms.
5. **Orders.** Omron will accept no order less than \$200 net billing.
6. **Governmental Approvals.** Buyer shall be responsible for, and shall bear all costs involved in, obtaining any government approvals required for the importation or sale of the Products.
7. **Taxes.** All taxes, duties and other governmental charges (other than general real property and income taxes), including any interest or penalties thereon, imposed directly or indirectly on Omron or required to be collected directly or indirectly by Omron for the manufacture, production, sale, delivery, importation, consumption or use of the Products sold hereunder (including customs duties and sales, excise, use, turnover and license taxes) shall be charged to and remitted by Buyer to Omron.
8. **Financial.** If the financial position of Buyer at any time becomes unsatisfactory to Omron, Omron reserves the right to stop shipments or require satisfactory security or payment in advance. If Buyer fails to make payment or otherwise comply with these Terms or any related agreement, Omron may (without liability and in addition to other remedies) cancel any unshipped portion of Products sold hereunder and stop any Products in transit until Buyer pays all amounts, including amounts payable hereunder, whether or not then due, which are owing to it by Buyer. Buyer shall in any event remain liable for all unpaid accounts.
9. **Cancellation; Etc.** Orders are not subject to rescheduling or cancellation unless Buyer indemnifies Omron against all related costs or expenses.
10. **Force Majeure.** Omron shall not be liable for any delay or failure in delivery resulting from causes beyond its control, including earthquakes, fires, floods, strikes or other labor disputes, shortage of labor or materials, accidents to machinery, acts of sabotage, riots, delay in or lack of transportation or the requirements of any government authority.
11. **Shipping; Delivery.** Unless otherwise expressly agreed in writing by Omron:
 - a. Shipments shall be by a carrier selected by Omron; Omron will not drop ship except in "break down" situations.
 - b. Such carrier shall act as the agent of Buyer and delivery to such carrier shall constitute delivery to Buyer;
 - c. All sales and shipments of Products shall be FOB shipping point (unless otherwise stated in writing by Omron), at which point title and risk of loss shall pass from Omron to Buyer; provided that Omron shall retain a security interest in the Products until the full purchase price is paid;
 - d. Delivery and shipping dates are estimates only; and
 - e. Omron will package Products as it deems proper for protection against normal handling and extra charges apply to special conditions.
12. **Claims.** Any claim by Buyer against Omron for shortage or damage to the Products occurring before delivery to the carrier must be presented in writing to Omron within 30 days of receipt of shipment and include the original transportation bill signed by the carrier noting that the carrier received the Products from Omron in the condition claimed.
13. **Warranties.** (a) **Exclusive Warranty.** Omron's exclusive warranty is that the Products will be free from defects in materials and workmanship for a period of twelve months from the date of sale by Omron (or such other period expressed in writing by Omron). Omron disclaims all other warranties, express or implied. (b) **Limitations.** OMRON MAKES NO WARRANTY OR REPRESENTATION, EXPRESS OR IMPLIED, ABOUT NON-INFRINGEMENT, MERCHANTABILITY OR FITNESS FOR A PARTICULAR PURPOSE OF THE PRODUCTS. BUYER ACKNOWLEDGES THAT IT ALONE HAS DETERMINED THAT THE PRODUCTS WILL SUITABLY MEET THE REQUIREMENTS OF THEIR INTENDED USE. Omron further disclaims all warranties and responsibility of any type for claims or expenses based on infringement by the Products or otherwise of any intellectual property right. (c) **Buyer Remedy.** Omron's sole obligation hereunder shall be, at Omron's election, to (i) replace (in the form originally shipped with Buyer responsible for labor charges for removal or replacement thereof) the non-complying Product, (ii) repair the non-complying Product, or (iii) repay or credit Buyer an amount equal to the purchase price of the non-complying Product; provided that in no event shall Omron be responsible for warranty, repair, indemnity or any other claims or expenses regarding the Products unless Omron's analysis confirms that the Products were properly handled, stored, installed and maintained and not subject to contamination, abuse, misuse or inappropriate modification. Return of any Products by Buyer must be approved in writing by Omron before shipment. Omron Companies shall not be liable for the suitability or unsuitability or the results from the use of Products in combination with any electrical or electronic components, circuits, system assemblies or any other materials or substances or environments. Any advice, recommendations or information given orally or in writing, are not to be construed as an amendment or addition to the above warranty. See <http://www.omron247.com> or contact your Omron representative for published information.
14. **Limitation on Liability; Etc.** OMRON COMPANIES SHALL NOT BE LIABLE FOR SPECIAL, INDIRECT, INCIDENTAL, OR CONSEQUENTIAL DAMAGES, LOSS OF PROFITS OR PRODUCTION OR COMMERCIAL LOSS IN ANY WAY CONNECTED WITH THE PRODUCTS, WHETHER SUCH CLAIM IS BASED IN CONTRACT, WARRANTY, NEGLIGENCE OR STRICT LIABILITY. Further, in no event shall liability of Omron Companies exceed the individual price of the Product on which liability is asserted.
15. **Indemnities.** Buyer shall indemnify and hold harmless Omron Companies and their employees from and against all liabilities, losses, claims, costs and expenses (including attorney's fees and expenses) related to any claim, investigation, litigation or proceeding (whether or not Omron is a party) which arises or is alleged to arise from Buyer's acts or omissions under these Terms or in any way with respect to the Products. Without limiting the foregoing, Buyer (at its own expense) shall indemnify and hold harmless Omron and defend or settle any action brought against such Companies to the extent based on a claim that any Product made to Buyer specifications infringed intellectual property rights of another party.
16. **Property; Confidentiality.** Any intellectual property in the Products is the exclusive property of Omron Companies and Buyer shall not attempt to duplicate it in any way without the written permission of Omron. Notwithstanding any charges to Buyer for engineering or tooling, all engineering and tooling shall remain the exclusive property of Omron. All information and materials supplied by Omron to Buyer relating to the Products are confidential and proprietary, and Buyer shall limit distribution thereof to its trusted employees and strictly prevent disclosure to any third party.
17. **Export Controls.** Buyer shall comply with all applicable laws, regulations and licenses regarding (i) export of products or information; (iii) sale of products to "forbidden" or other proscribed persons; and (ii) disclosure to non-citizens of regulated technology or information.
18. **Miscellaneous.** (a) **Waiver.** No failure or delay by Omron in exercising any right and no course of dealing between Buyer and Omron shall operate as a waiver of rights by Omron. (b) **Assignment.** Buyer may not assign its rights hereunder without Omron's written consent. (c) **Law.** These Terms are governed by the law of the jurisdiction of the home office of the Omron company from which Buyer is purchasing the Products (without regard to conflict of law principles). (d) **Amendment.** These Terms constitute the entire agreement between Buyer and Omron relating to the Products, and no provision may be changed or waived unless in writing signed by the parties. (e) **Severability.** If any provision hereof is rendered ineffective or invalid, such provision shall not invalidate any other provision. (f) **Setoff.** Buyer shall have no right to set off any amounts against the amount owing in respect of this invoice. (g) **Definitions.** As used herein, "including" means "including without limitation"; and "Omron Companies" (or similar words) mean Omron Corporation and any direct or indirect subsidiary or affiliate thereof.

Certain Precautions on Specifications and Use

1. **Suitability of Use.** Omron Companies shall not be responsible for conformity with any standards, codes or regulations which apply to the combination of the Product in the Buyer's application or use of the Product. At Buyer's request, Omron will provide applicable third party certification documents identifying ratings and limitations of use which apply to the Product. This information by itself is not sufficient for a complete determination of the suitability of the Product in combination with the end product, machine, system, or other application or use. Buyer shall be solely responsible for determining appropriateness of the particular Product with respect to Buyer's application, product or system. Buyer shall take application responsibility in all cases but the following is a non-exhaustive list of applications for which particular attention must be given:
 - (i) Outdoor use, uses involving potential chemical contamination or electrical interference, or conditions or uses not described in this document.
 - (ii) Use in consumer products or any use in significant quantities.
 - (iii) Energy control systems, combustion systems, railroad systems, aviation systems, medical equipment, amusement machines, vehicles, safety equipment, and installations subject to separate industry or government regulations.
 - (iv) Systems, machines and equipment that could present a risk to life or property. Please know and observe all prohibitions of use applicable to this Product.

NEVER USE THE PRODUCT FOR AN APPLICATION INVOLVING SERIOUS RISK TO LIFE OR PROPERTY OR IN LARGE QUANTITIES WITHOUT ENSURING THAT THE SYSTEM AS A WHOLE HAS BEEN DESIGNED TO ADDRESS THE RISKS, AND THAT THE OMRON'S PRODUCT IS PROPERLY RATED AND INSTALLED FOR THE INTENDED USE WITHIN THE OVERALL EQUIPMENT OR SYSTEM.
2. **Programmable Products.** Omron Companies shall not be responsible for the user's programming of a programmable Product, or any consequence thereof.
3. **Performance Data.** Data presented in Omron Company websites, catalogs and other materials is provided as a guide for the user in determining suitability and does not constitute a warranty. It may represent the result of Omron's test conditions, and the user must correlate it to actual application requirements. Actual performance is subject to the Omron's Warranty and Limitations of Liability.
4. **Change in Specifications.** Product specifications and accessories may be changed at any time based on improvements and other reasons. It is our practice to change part numbers when published ratings or features are changed, or when significant construction changes are made. However, some specifications of the Product may be changed without any notice. When in doubt, special part numbers may be assigned to fix or establish key specifications for your application. Please consult with your Omron's representative at any time to confirm actual specifications of purchased Product.
5. **Errors and Omissions.** Information presented by Omron Companies has been checked and is believed to be accurate; however, no responsibility is assumed for clerical, typographical or proofreading errors or omissions.

OMRON AUTOMATION AND SAFETY • THE AMERICAS HEADQUARTERS • Hoffman Estates, IL USA • 847.843.7900 • 800.556.6766 • www.omron247.com

OMRON CANADA, INC. • HEAD OFFICE

Toronto, ON, Canada • 416.286.6465 • 866.986.6766 • www.omron247.com

OMRON ELECTRONICS DE MEXICO • HEAD OFFICE

México DF • 52.55.59.01.43.00 • 01-800-226-6766 • mela@omron.com

OMRON ELECTRONICS DE MEXICO • SALES OFFICE

Apodaca, N.L. • 52.81.11.56.99.20 • 01-800-226-6766 • mela@omron.com

OMRON ELETRÔNICA DO BRASIL LTDA • HEAD OFFICE

São Paulo, SP, Brasil • 55.11.2101.6300 • www.omron.com.br

OMRON ARGENTINA • SALES OFFICE

Cono Sur • 54.11.4783.5300

OMRON CHILE • SALES OFFICE

Santiago • 56.9.9917.3920

OTHER OMRON LATIN AMERICA SALES

54.11.4783.5300

OMRON EUROPE B.V. • Wegalaan 67-69, NL-2132 JD, Hoofddorp, The Netherlands. • +31 (0) 23 568 13 00 • www.industrial.omron.eu

Authorized Distributor:

Automation Control Systems

- Machine Automation Controllers (MAC) • Programmable Controllers (PLC)
- Operator interfaces (HMI) • Distributed I/O • Software

Drives & Motion Controls

- Servo & AC Drives • Motion Controllers & Encoders

Temperature & Process Controllers

- Single and Multi-loop Controllers

Sensors & Vision

- Proximity Sensors • Photoelectric Sensors • Fiber-Optic Sensors
- Amplified Photomicrosensors • Measurement Sensors
- Ultrasonic Sensors • Vision Sensors

Industrial Components

- RFID/Code Readers • Relays • Pushbuttons & Indicators
- Limit and Basic Switches • Timers • Counters • Metering Devices
- Power Supplies

Safety

- Laser Scanners • Safety Mats • Edges and Bumpers • Programmable Safety Controllers • Light Curtains • Safety Relays • Safety Interlock Switches