

20W, wide input isolated & regulated dual / single output DC/DC converter

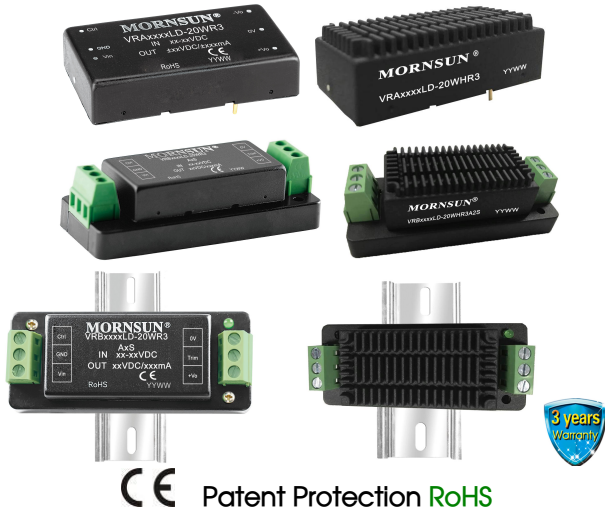

FEATURES

- wide input voltage rang (2:1)
- High efficiency up to 90%
- No-load power consumption as low as 0.15W
- Isolation voltage :1.5KVDC
- output short circuit protection, over-voltage protection, over-current protection
- Operating temperature range: -40°C to +85°C
- Meet CISPR32/EN55032 CLASS A, without external components
- Six-sided metal shielding package
- Reverse voltage protection available with A2S(Chassis mounting) or A4S(35mm DIN-Rail mounting)
- EN60950 approval

VRA_LD-20WR3 & VRB_LD-20WR3 series are isolated 20W DC-DC products with 2:1 input voltage. They feature efficiency up to 90%, 1500VDC isolation, operating temperature of -40°C to +85°C, output short circuit protection, over-voltage protection, over-current protection and EMI meets CISPR32/EN55032 CLASS A, without external components which make them widely applied in data transmission device, battery power supplies, Tele-communication device, distributed power supply system, remote control system, industrial robot system fields. And extension package A2S and A4S also enable them with reverse voltage protection.

Selection Guide

Certification	Part No. ①	Input Voltage (VDC)		Output		Efficiency ^③ (%,Min./Typ.) @ Full Load	Max. Capacitive Load ^④ (μF)		
		Nominal (Range)	Max. ②	Output Voltage (VDC)	Output Current (mA)(Max./Min.)				
--	VRB121DLD-20WR3	12 (9-18)	20	110	182/9	86/88	66		
CE	VRA2405LD-20WR3	24 (18-36)	40	±5	±2000/0	84/86	4800		
	VRA2409LD-20WR3			±9	±1111/0	86/88	1000		
	VRA2412LD-20WR3			±12	±834/0	86/88	800		
	VRA2415LD-20WR3			±15	±667/0	86/88	625		
--	VRA2424LD-20WR3					±24	±417/0	86/88	500
CE	VRB2403LD-20WR3					3.3	5000/0	84/86	10000
	VRB2405LD-20WR3					5	4000/0	88/90	10000
	VRB2409LD-20WR3					9	2222/0	87/89	4700
	VRB2412LD-20WR3					12	1667/0	87/89	1600
	VRB2415LD-20WR3					15	1333/0	88/90	1000
	VRB2424LD-20WR3			24	834/0	88/90	500		
	VRA4805LD-20WR3	48 (36-75)	80	±5	±2000/0	84/86	4800		
	VRA4812LD-20WR3			±12	±834/0	86/88	800		
	VRA4815LD-20WR3			±15	±667/0	87/89	625		
	VRB4803LD-20WR3			3.3	5000/0	84/86	10000		
	VRB4805LD-20WR3			5	4000/0	88/90	10000		
	VRB4809LD-20WR3			9	2222/0	87/89	4700		
	VRB4812LD-20WR3			12	1667/0	87/89	1600		
	VRB4815LD-20WR3			15	1333/0	88/90	1000		
VRB4824LD-20WR3	24			834/0	88/90	500			

Notes: ①Series with suffix "H" are heat sink mounting; series with suffix "A2S" are chassis mounting, with suffix "A4S" are DIN-Rail mounting, for example VRB2405LD-20WHR3A2S is chassis mounting of with heat sink, VRB2405LD-20WR3A4S is DIN-Rail mounting of without heat sink; If the application has a higher requirement for heat dissipation, you can choose modules with heat sink;
 ②Absolute maximum rating without damage on the converter, but it isn't recommended;
 ③Efficiency is measured in nominal input voltage and rated output load; A2S (wiring) and A4S (rail) Model due to input reverse polarity protection, minimum efficiency greater than Min.-2 is qualified;
 ④ The capacitive loads of positive and negative outputs are identical.

Input Specifications

Item	Operating Conditions	Min.	Typ.	Max.	Unit	
Input Current (full load / no-load)	12VDC input	--	1894/35	1938/--	mA	
	24VDC input	3.3V output	--	799/40		818/45
		5V output	--	969/40		993/45
		Others	--	947/6		969/10
	48VDC input	3.3V output	--	400/20		409/25
		5V output	--	485/20		497/25
Others		--	474/5	485/9		
Reflected Ripple Current	12VDC input	--	20	--		
	24VDC / 48VDC input	--	30	--		
Surge Voltage (1sec. max.)	12VDC input	-0.7	--	25	VDC	
	24VDC input	-0.7	--	50		
	48VDC input	-0.7	--	100		
Starting Voltage	12VDC input	--	--	9		
	24VDC input	--	--	18		
	48VDC input	--	--	36		
Starting Time	Nominal input voltage & constant resistance load	--	10	--	ms	
Input Filter		Pi filter				
Ctrl ^①	Module switch on	Ctrl suspended or connected to TTL high level (3.5-12VDC)				
	Module switch off	Ctrl pin connected to GND or low level (0-1.2VDC)				
	Input current when switched off	VRB121DLD-20WR3	--	5	--	mA
Others		--	4	7		
Hot Plug		Unavailable				

Note: ①The voltage of Ctrl pin is relative to input pin GND.

Output Specifications

Item	Operating Conditions	Min.	Typ.	Max.	Unit	
Output Voltage Accuracy ^①	0%-100% load	--	±1	±3	%	
Line Regulation	Full load,the input voltage is from low voltage to high voltage	Positive output	--	±0.2		±0.5
		Negative output	--	±0.5		±1
Load Regulation ^②	5%-100% load	Positive output	--	±0.5		±1
		Negative output	--	±0.5		±1.5
Cross Regulation	Dual output, main output 50% load, Supplement output from 10%-100% load	--	--	±5		
Transient Recovery Time	25% load step change, Nominal input voltage		--	300	500	μs
Transient Response Deviation		3.3V/5V/±5V output	--	±5	±8	%
		Others	--	±3	±5	
Temperature Coefficient	Full load	--	--	±0.03	%/°C	
Ripple & Noise ^③	20MHz bandwidth, 5%-100% load	VRB121DLD-20WR3	--	--	250	mVp-p
		Others	--	50	100	
Trim	Input voltage range(24V/48V input)		--	±10	--	%Vo
Over-voltage Protection			110	--	160	
Over-current Protection		Input voltage range	VRB121DLD-20WR3	--	130	
	Others		110	--	190	
Short circuit Protection		Hiccup, Continuous, self-recovery				

Note:
 ①At 0%~5% load, the Max. output voltage accuracy of ±5VDC/±9VDC output converter is ±5%;
 ②When testing from 0% to 100%load working conditions, load regulation index of ±5%;
 ③0%-5% load ripple&Noise is no more than 5%Vo.Ripple and noise are measured by "parallel cable" method, please see DC-DC Converter Application Notes for specific operation.

General Specifications

Item	Operating Conditions	Min.	Typ.	Max.	Unit	
Insulation Voltage	Input-output, with the test time of 1 minute and the leak current lower than 1mA	1500	--	--	VDC	
Insulation Resistance	Input-output, insulation voltage 500VDC	1000	--	--	MΩ	
Isolation Capacitance	Input-output, 100KHz/0.1V	VRB2424LD-20W(H)R3 (A2S/A4S)	--	2050	--	pF
		VRB121DLD-20WR3	--	2000	--	
		Others	--	1050	--	
Operating Temperature	see Fig. 1	-40	--	+85	℃	
Storage Temperature		-55	--	+125		
Storage Humidity	Non-condensing	5	--	95	%RH	
Pin Welding Resistance Temperature	Welding spot is 1.5mm away from the casing, 10 seconds	--	--	+300	℃	
Max. Casing Temperature	Refer to temperature derating curve (VRB121DLD-20WR3)	--	--	105		
Vibration		10-55Hz, 10G, 30 Min. along X, Y and Z				
Switching Frequency ^①	PWM mode	VRB121DLD-20WR3	--	300	--	KHz
		Others	--	270	--	
MTBF	MIL-HDBK-217F@25℃	1000	--	--	K hours	

Note: ① This series of products using reduced frequency technology, the switching frequency is test value of full load. When the load is reduced to below 50%, the switching frequency decreases with decreasing load.

Physical Specifications

Casing Material			Aluminum alloy
Dimension	Horizontal package(without heat sink)		50.80*25.40*11.80 mm
	Horizontal package(with heat sink)		51.40*26.20*16.50 mm
	A2S wiring package (without heat sink)		76.00*31.50*21.20 mm
	A2S wiring package(with heat sink)		76.00*31.50*25.30 mm
	A4S rail package(without heat sink)		76.00*31.50*25.80 mm
	A4S rail package(with heat sink)		76.00*31.50*29.90 mm
Weight	without heat sink	Horizontal package/A2S wiring package/A4S rail package	26g/48g/68g(Typ.)
	with heat sink	Horizontal package/A2S wiring package/A4S rail package	34g/56g/76g(Typ.)
Cooling Method			Free air convection

EMC Specifications

EMI	CE	CISPR32/EN55032	CLASS A (without external component)/ CLASS B (see Fig.3-① for recommended circuit)
	RE	CISPR32/EN55032	CLASS A (without external component)/ CLASS B (see Fig.3-① for recommended circuit) (except VRB121DLD-20WR3)
EMS	ESD	IEC/EN61000-4-2	Contact ±4KV perf. Criteria B
	RS	IEC/EN61000-4-3	10V/m perf. Criteria A
	EFT	IEC/EN61000-4-4	±2KV (see Fig.3-② for recommended circuit) perf. Criteria B
	Surge	IEC/EN61000-4-5	line to line ±2KV (see Fig.3-② for recommended circuit) perf. Criteria B
	CS	IEC/EN61000-4-6	3 Vr.m.s perf. Criteria A
	Voltage dips, short interruptions and voltage variations immunity	IEC/EN61000-4-29	0%, 70% perf. Criteria B

Product Characteristic Curve

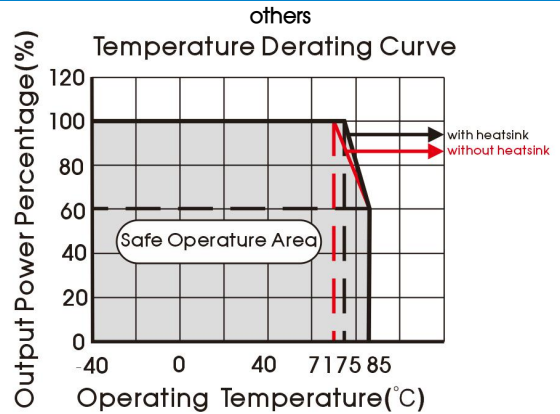
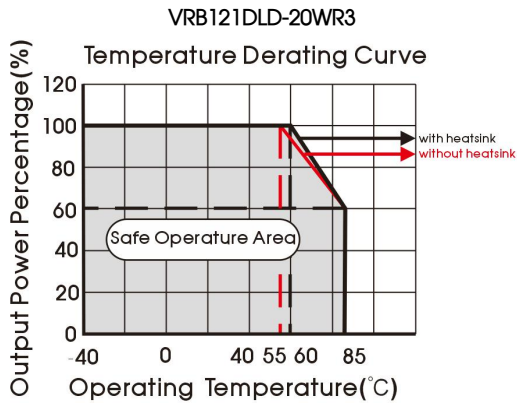
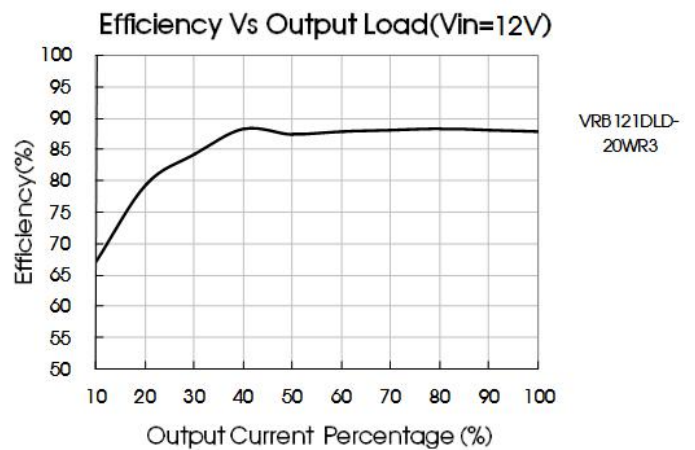
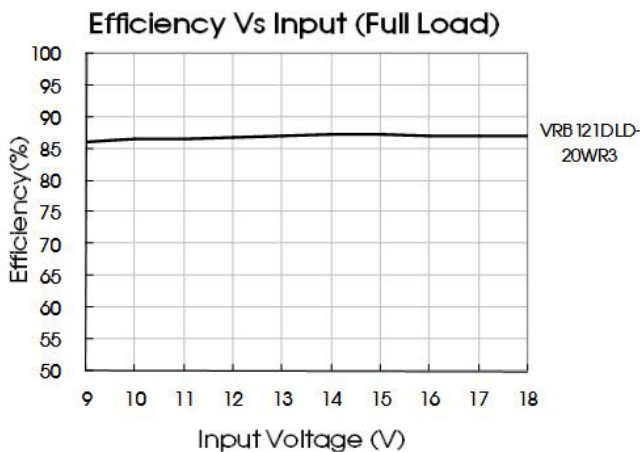
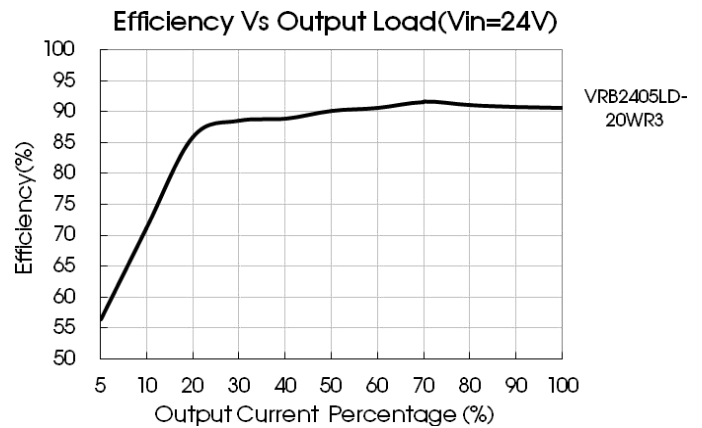
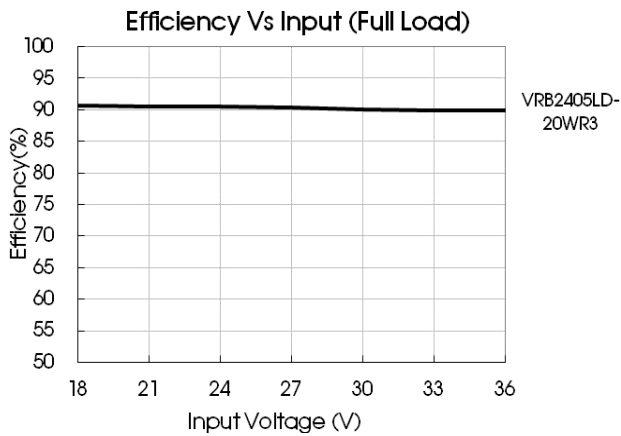
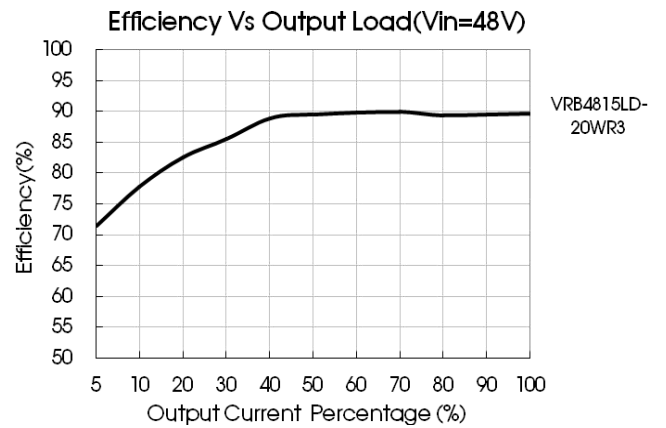
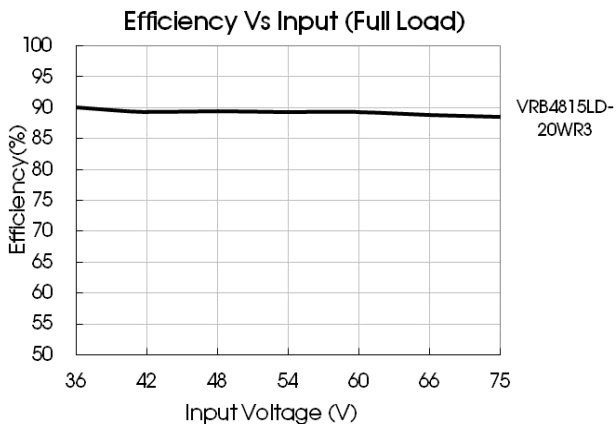

Fig. 1



Design Reference

1. Typical application

All the DC/DC converters of this series are tested according to the recommended circuit (see Fig. 2) before delivery. If it is required to further reduce input and output ripple, properly increase the input & output of additional capacitors Cin and Cout or select capacitors of low equivalent impedance provided that the capacitance is no larger than the max. capacitive load of the product.

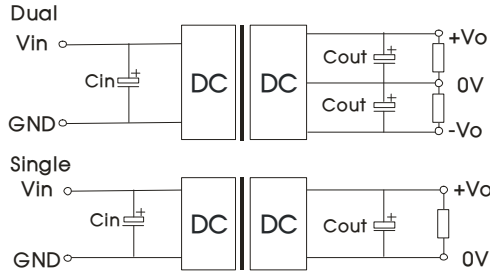
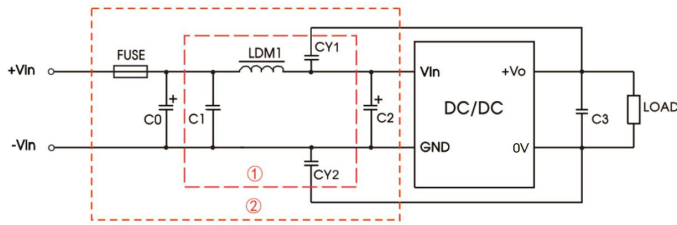

Fig. 2

Single Vout (VDC)	Cout (μF)	Cin (μF)	Dual Vout (VDC)	Cout (μF)	Cin (μF)
3.3/5	470	100	±5	220	100
9/12/15	220		±9/±12/±15	100	
24/110	100		±24	100	

2. EMC solution-recommended circuit

Single:



Dual:

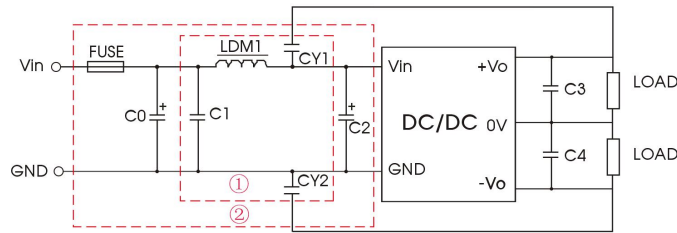

Fig. 3

Notes: Part ① in the Fig. 3 is used for EMI test and part ② for EMC filtering; selected based on needs.

Parameter description

Model	Vin:12V/24V	Vin:48V
FUSE	Choose according to actual input current	
C0	680μF/100V	680μF/100V
C1	1μF/50V	1μF/100V
C2	330μF/50V	330μF/100V
C3 / C4	Refer to the Cout in Fig.2	
LDM1	4.7μH	
CY1/ CY2	1nF/2KV	

3. Application of Trim and calculation of Trim resistance

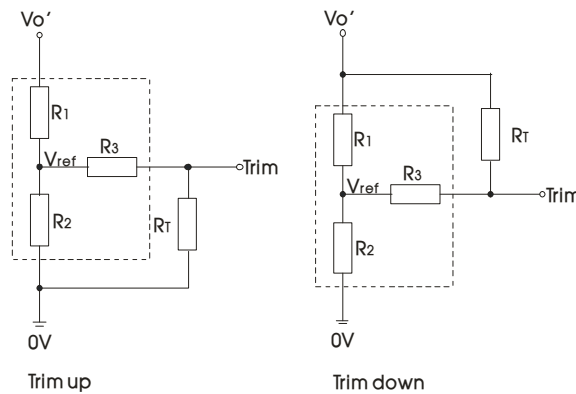

Applied circuits of Trim (Part in broken line is the interior of models)

Calculation formula of Trim resistance:

$$\begin{aligned} \text{up: } R_T &= \frac{aR_2}{R_2-a} - R_3 & a &= \frac{V_{ref}}{V_{o'} - V_{ref}} \cdot R_1 \\ \text{down: } R_T &= \frac{aR_1}{R_1-a} - R_3 & a &= \frac{V_{o'} - V_{ref}}{V_{ref}} \cdot R_2 \end{aligned}$$

RT is Trim resistance
a is a self-defined parameter, with no real meaning.

Vout(V)	R1(KΩ)	R2(KΩ)	R3(KΩ)	Vref(V)
3.3	4.801	2.87	12.4	1.24
5	2.883	2.87	10	2.5
9	7.500	2.87	15	2.5
12	11.000	2.87	15	2.5
15	14.494	2.87	15	2.5
24	24.872	2.87	17.8	2.5

- It is not allowed to connect modules output in parallel to enlarge the power
- For more information please find DC-DC converter application notes on www.mornsun-power.com

Horizontal Package (without heat sink) Dimensions and Recommended Layout

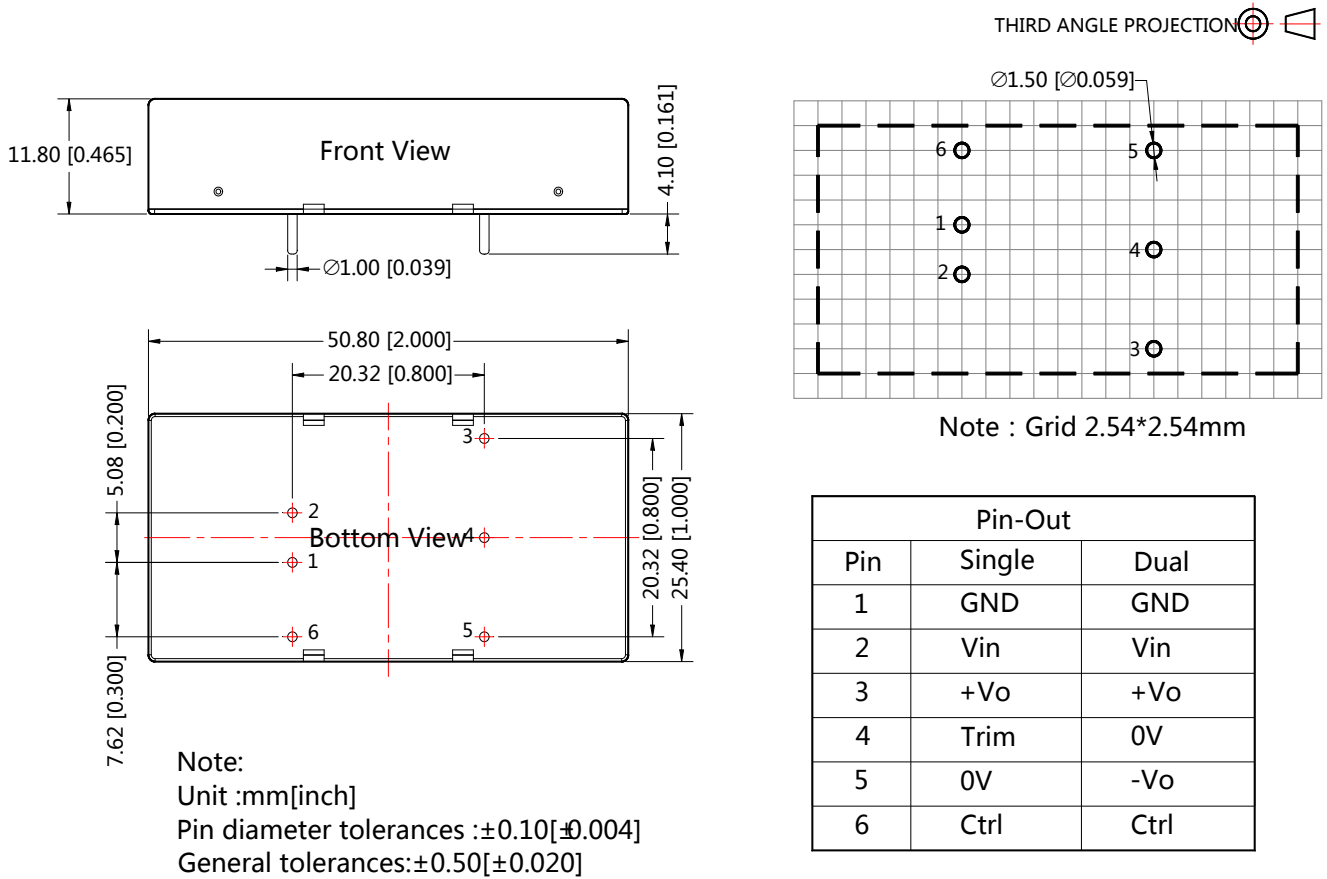

Horizontal Package (with heat sink) Dimensions

THIRD ANGLE PROJECTION 

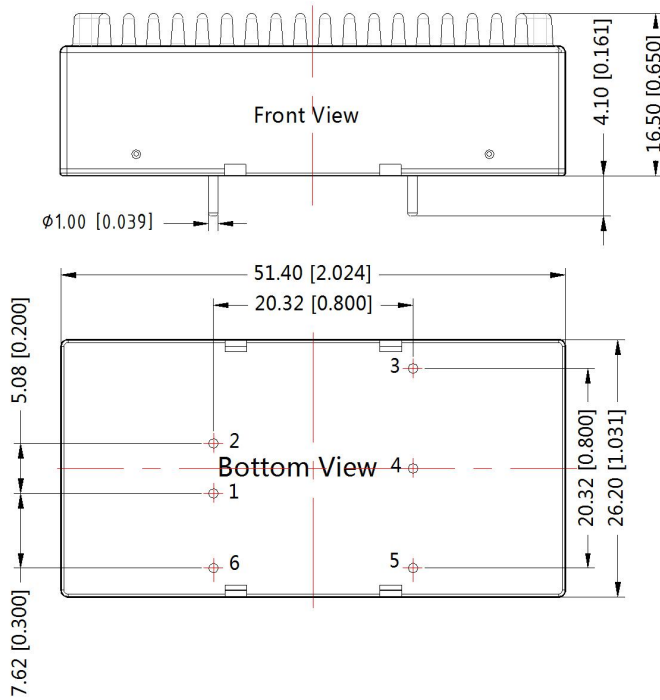

Pin-Out		
Pin	Single	Dual
1	GND	GND
2	Vin	Vin
3	+Vo	+Vo
4	Trim	0V
5	0V	-Vo
6	Ctrl	Ctrl

Note:
Unit: mm[inch]
General tolerances: $\pm 0.50[\pm 0.020]$

VRA_LD-20WR3A2S & VRB_LD-20WR3A2S(without heat sink) Dimensions

THIRD ANGLE PROJECTION 

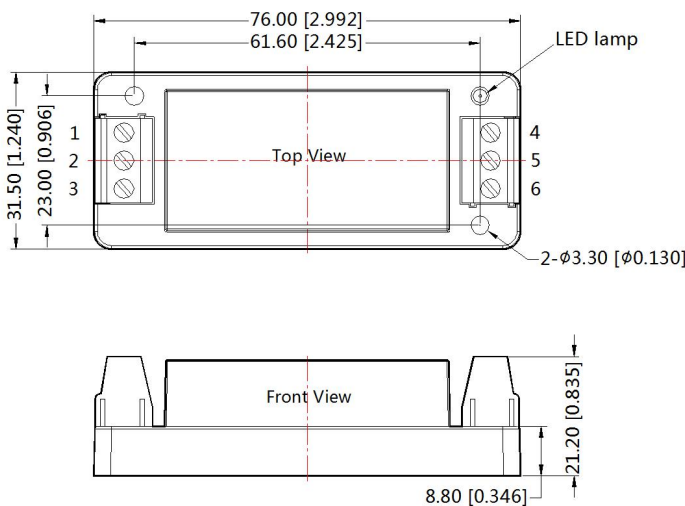

Pin-Out						
Pin	1	2	3	4	5	6
Dual	Ctrl	GND	Vin	-Vo	0V	+Vo
Single	Ctrl	GND	Vin	0V	Trim	+Vo

Note:
Unit: mm[inch]
Wire range: 24-12 AWG
Tightening torque: Max 0.4 N·m
General tolerances: $\pm 0.50[\pm 0.020]$

VRA_LD-20WHR3A2S & VRB_LD-20WHR3A2S(with heat sink) Dimensions

THIRD ANGLE PROJECTION 

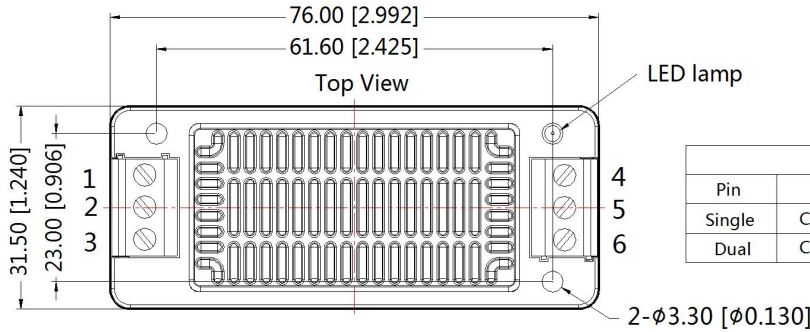

Pin-Out						
Pin	1	2	3	4	5	6
Single	Ctrl	GND	Vin	0V	Trim	+Vo
Dual	Ctrl	GND	Vin	-Vo	0V	+Vo

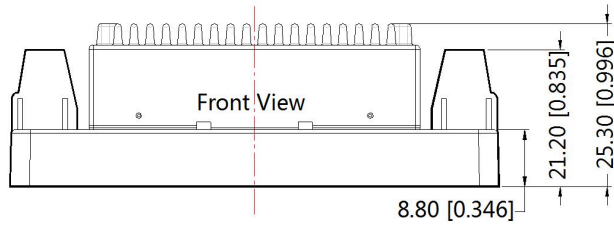

Note:
 Unit: mm[inch]
 Wire range: 24-12 AWG
 Tightening torque: Max 0.4 N·m
 General tolerances: ±0.50[±0.020]

VRA_LD-20WR3A4S & VRB_LD-20WR3A4S(without heat sink) Dimensions

THIRD ANGLE PROJECTION 

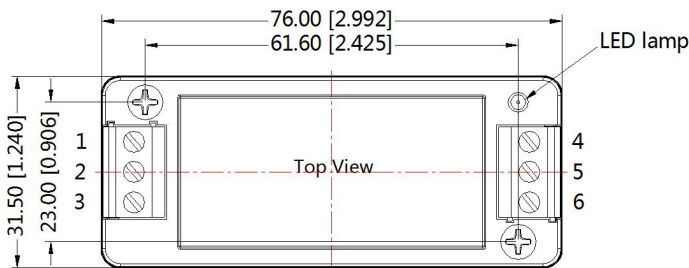

Pin-Out						
Pin	1	2	3	4	5	6
Dual	Ctrl	GND	Vin	-Vo	0V	+Vo
Single	Ctrl	GND	Vin	0V	Trim	+Vo

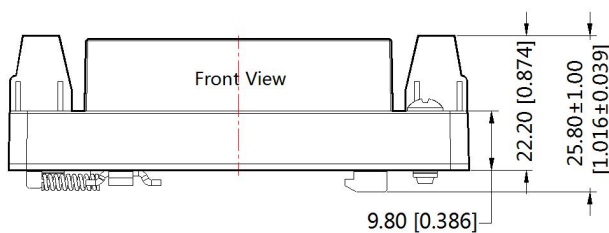

Note:
 Unit: mm[inch]
 Wire range: 24-12 AWG
 Tightening torque: Max 0.4 N·m
 General tolerances: ±0.50[±0.020]

VRA_LD-20WHR3A4S & VRB_LD-20WHR3A4S(with heat sink) Dimensions

THIRD ANGLE PROJECTION 

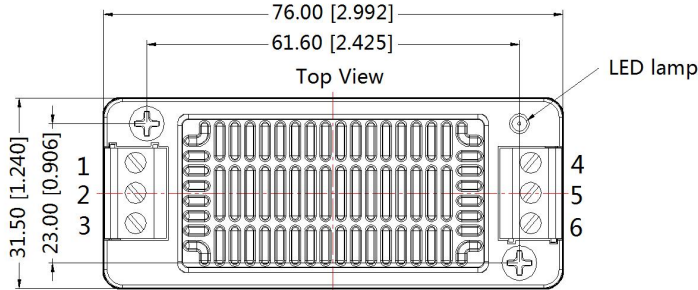

Pin-Out						
Pin	1	2	3	4	5	6
Single	Ctrl	GND	Vin	0V	Trim	+Vo
Dual	Ctrl	GND	Vin	-Vo	0V	+Vo

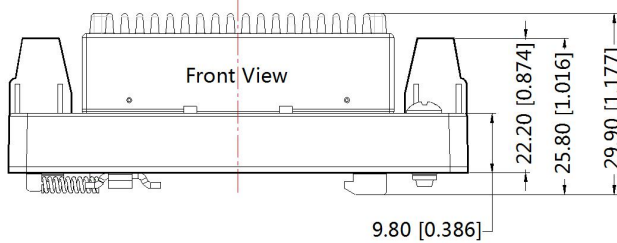

Note:
Unit: mm[inch]
Mounting rail: TS35
Wire range: 24-12 AWG
Tightening torque: Max 0.4 N·m
General tolerances: $\pm 1.00[\pm 0.039]$

Notes:

1. Packing information please refer to Product Packing Information which can be downloaded from www.mornsun-power.com. The Packing bag number of Horizontal package :58200035(without heat sink), 58200051(with heat sink, A2S/ A4S package number: 58220022;
2. The maximum capacitive load offered were tested at input voltage range and full load;
3. Unless otherwise specified, parameters in this datasheet were measured under the conditions of $T_a=25^\circ\text{C}$, humidity<75%RH with nominal input voltage and rated output load;
4. All index testing methods in this datasheet are based on Company's corporate standards;
5. We can provide product customization service, please contact our technicians directly for specific information;
6. Products are related to laws and regulations: see "Features" and "EMC";
7. Our products shall be classified according to ISO14001 and related environmental laws and regulations, and shall be handled by qualified units.

Mornsun Guangzhou Science & Technology Co., Ltd.

Address: No. 5, Kehui St. 1, Kehui Development Center, Science Ave., Guangzhou Science City, Luogang District, Guangzhou, P. R. China
Tel: 86-20-38601850 Fax: 86-20-38601272 E-mail: sales@mornsun.cn www.mornsun-power.com