



CHENMKO ENTERPRISE CO.,LTD

Lead free devices

**SURFACE MOUNT
SWITCHING DIODE ARRAY**

VOLTAGE 80 Volts CURRENT 500 mAmpere

CH004SDWPT

APPLICATION

- * Ultra high speed switching
- * For general purpose switching application

FEATURE

- * Small surface mounting type. (SC-88/SOT-363)
- * High speed. ($T_{RR}=1.5nSec$ Typ.)
- * Suitable for high packing density.
- * Maximum total power dissipation is 300mW.
- * Peak forward current is 350mA.

CONSTRUCTION

- * Silicon epitaxial planar

MARKING

- * DD

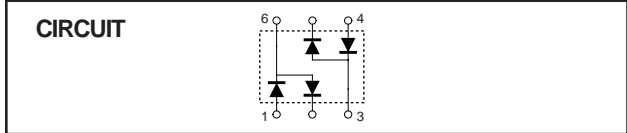
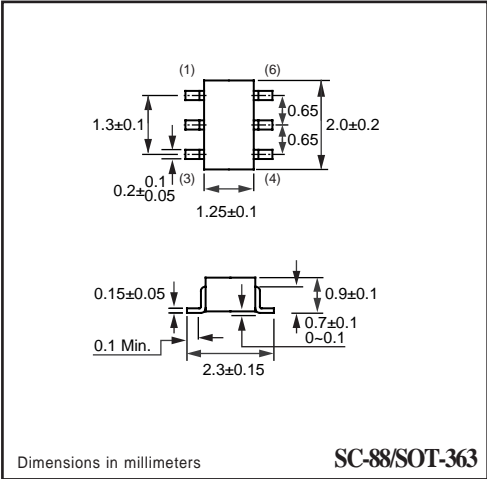
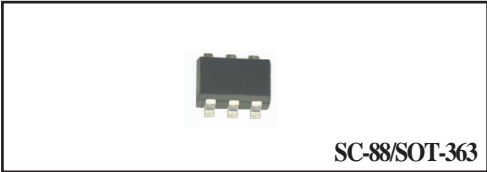

MAXIMUM RATINGS (At $T_A = 25^\circ C$ unless otherwise noted)

RATINGS	SYMBOL	CH004SDWPT	UNITS
Maximum Non-Repetitive Peak Reverse Voltage	V_{RM}	100	Volts
Maximum RMS Voltage	V_{RMS}	80	Volts
Maximum Repetitive Peak Reverse and DC Blocking Voltage	$V_{RRM, VDC}$	80	Volts
Maximum Average Forward Rectified Current	I_O	500	mAmps
Non-Repetitive Peak Forward Surge Current	@ $t=1.0\mu Sec$	20	Amps
	@ $t=1.0Sec$	2.0	
Typical Junction Capacitance between Terminal (Note 1)	C_J	4.0	pF
Maximum Reverse Recovery Time (Note 2)	T_{RR}	4.0	nSec
Thermal Resistance Junction to Ambient (Note 3)	$R_{\theta JA}$	625	$^\circ C/W$
Maximum Operating and Storage Temperature Range	$T_{J, TSTG}$	-65 to +150	$^\circ C$

ELECTRICAL CHARACTERISTICS (At $T_A = 25^\circ C$ unless otherwise noted)

CHARACTERISTICS	SYMBOL	CH004SDWPT	UNITS
Maximum Instantaneous Forward Voltage	V_F	@ $I_F=5.0mA$	0.72
		@ $I_F=20mA$	0.93
		@ $I_F=100mA$	1.00
		@ $I_F=150mA$	1.25
Maximum Average Reverse Current	I_R	@ $V_R=20V$	25
		@ $V_R=70V$	0.1
		@ $V_R=25V, T_J=150^\circ C$	30
		@ $V_R=75V, T_J=150^\circ C$	50

- NOTES :
1. Measured at 1.0 MHz and applied reverse voltage of 0 volts.
 2. Measured at applied forward current of 10mA and reverse current of 10mA.
 3. Device mounted on FR-4 by 1 inch X 0.85 inch X 0.062 inch
 4. ESD sensitive product handling required.

2004-10

RATING CHARACTERISTIC CURVES (CH004SDWPT)

FIG. 1 - TYPICAL FORWARD CURRENT DERATING CURVE

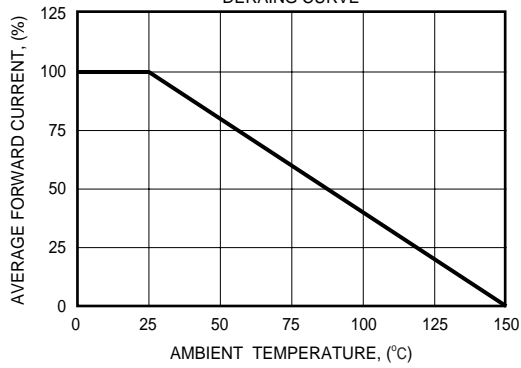

FIG. 2 - FORWARD CHARACTERISTICS

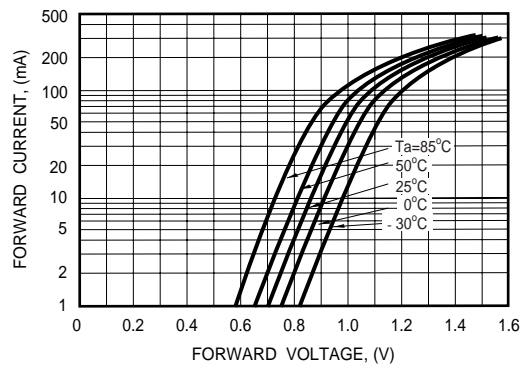

FIG. 3 - TYPICAL JUNCTION CAPACITANCE

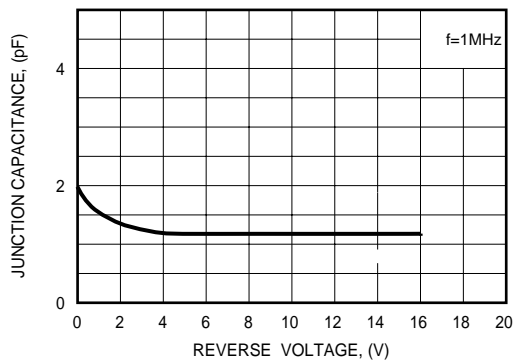

FIG. 4 - REVERSE CHARACTERISTICS

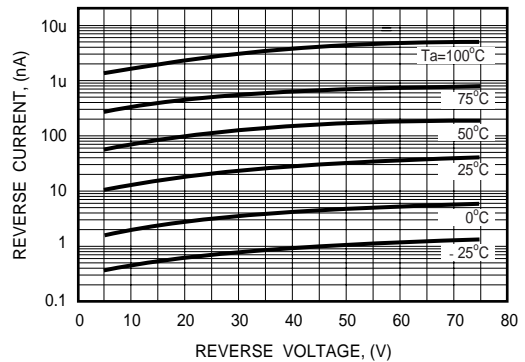

FIG. 5 - REVERSE RECOVERY TIME

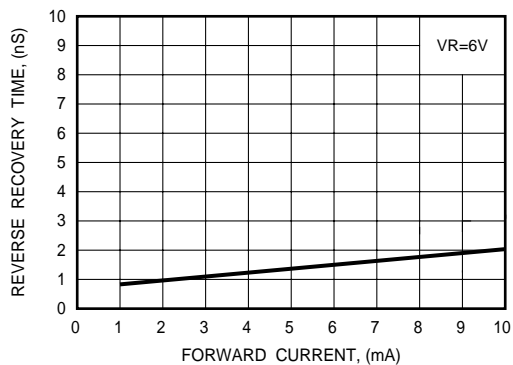

FIG. 6 - REVERSE RECOVERY TIME MEASUREMENT CIRCUIT

