



## L1119

CMOS IC

### 1.5A LOW DROPOUT REGULATORS

#### DESCRIPTION

The UTC **L1119** is a fast ultra low-dropout linear regulator that developed in CMOS process which allows low quiescent current operation independent of output load current. This CMOS process also allows the device to operate under extremely low dropout conditions.

The UTC **L1119** allows to operate from a 2.5V~7.0V input supply. Wide range of preset output voltage options are available and respond very fast to step changes in load which makes them suitable for low voltage microprocessor applications.

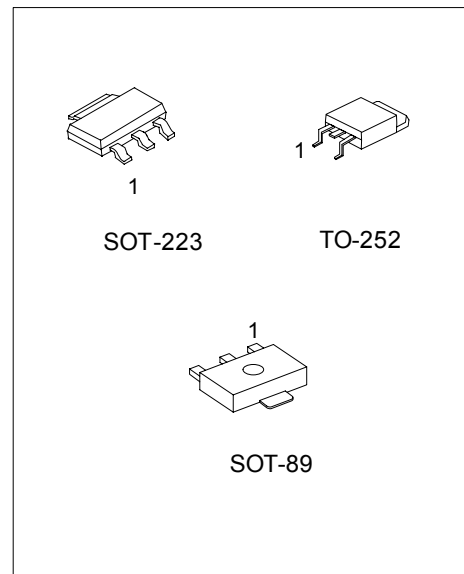

\*Pb-free plating product number: L1119L-xx

#### FEATURES

- \* Low ground current
- \* Load regulation of 0.04%
- \* Output current of 1.5A DC is guaranteed
- \* Accurate output voltage.(± 1.5%)
- \* Extremely low output capacitor requirements
- \* Over temperature/ Over current protection

#### ORDERING INFORMATION

Order Number		Package	Pin Assignment			Packing
Normal	Lead Free Plating		1	2	3	
L1119-xx-AA3-A-R	L1119L-xx-AA3-A-R	SOT-223	G	O	I	Tape Reel
L1119-xx-AA3-C-R	L1119L-xx-AA3-C-R	SOT-223	G	I	O	Tape Reel
L1119-xx-AB3-A-R	L1119L-xx-AB3-A-R	SOT-89	G	O	I	Tape Reel
L1119-xx-AB3-B-R	L1119L-xx-AB3-B-R	SOT-89	O	G	I	Tape Reel
L1119-xx-AB3-C-R	L1119L-xx-AB3-C-R	SOT-89	G	I	O	Tape Reel
L1119-xx-AB3-D-R	L1119L-xx-AB3-D-R	SOT-89	I	G	O	Tape Reel
L1119-xx-TN3-D-R	L1119L-xx-TN3-D-R	TO-252	I	G	O	Tape Reel
L1119-xx-TN3-D-T	L1119L-xx-TN3-D-T	TO-252	I	G	O	Tube

Note: Pin assignment: I: V<sub>IN</sub> O: V<sub>OUT</sub> G:GND

<p>L1119L-xx-AA3-A-R</p> <p>(1)Packing Type (2)Pin Assignment (3)Package Type (4)Output Voltage Code (5)Lead Plating</p>	<p>(1) R: Tape Reel, T: Tube (2) refer to Pin Assignment (3) AA3: SOT-223, AB3: SOT-89, TN3: TO-252 (4) xx: refer to Marking Information (5) L: Lead Free Plating, Blank: Pb/Sn</p>
--	---

■ MARKING INFORMATION

PACKAGE	VOLTAGE CODE	MARKING
SOT-223	12 :1.2V 15 :1.5V 18 :1.8V 25 :2.5V 33 :3.3V 50 :5.0V	
SOT-89		
TO-252		

■ BLOCK DIAGRAM

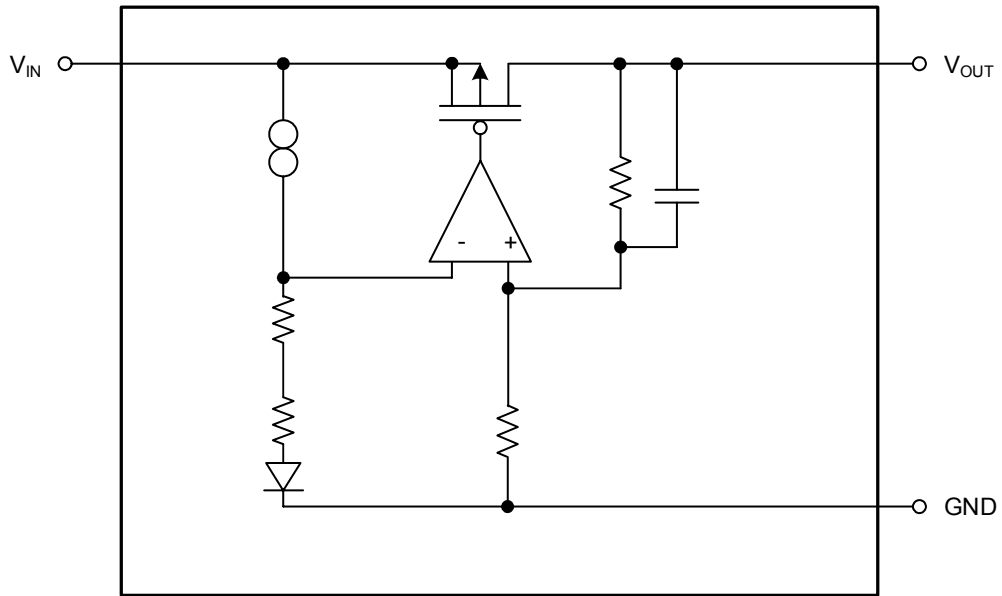

### ■ ABSOLUTE MAXIMUM RATINGS

PARAMETER	SYMBOL	RATINGS	UNIT
Input Supply Voltage	$V_{IN}$	-0.3 ~ +7.5	V
Output Voltage	$V_{OUT}$	-0.3 ~ +7.5	V
Output Current	$I_{OUT}$	Short Circuit Protected	
Power Dissipation	$P_D$	Internally Limited	
Operating Junction Temperature	$T_{OPR}$	-40 ~ +125	
Storage Temperature	$T_{STG}$	-65 ~ +150	

Note Absolute maximum ratings are those values beyond which the device could be permanently damaged.

Absolute maximum ratings are stress ratings only and functional device operation is not implied.

### ■ RECOMMENDED OPERATING RATINGS

PARAMETER	SYMBOL	RATINGS	UNIT
Input Supply Voltage	$V_{IN}$	2.5 ~ 7.0	V
Maximum Operating Current (DC)	$I_{OPR(MAX)}$	1.5	A
Operating Junction Temperature	$T_J$	-40 ~ +125	

Note: Absolute maximum ratings are those values beyond which the device could be permanently damaged.

Absolute maximum ratings are stress ratings only and functional device operation is not implied.

### ■ ELECTRICAL CHARACTERISTICS

( $T_J=25^\circ\text{C}$ ,  $V_{IN}=V_{OUT}+1\text{V}$ ,  $I_L=10\text{mA}$ ,  $C_{OUT}=33\mu\text{F}$ , unless otherwise specified.)

PARAMETER	SYMBOL	TEST CONDITIONS	MIN	TYP	MAX	UNIT
Dropout Voltage (Note)	$V_D$	$I_L = 150\text{ mA}$		38	45	mV
		$I_L = 1.5\text{ A}$		870		
Peak Output Current	$I_{PEAK}$		2.0	2.5		A
Ground Pin Current	$I_{GND}$	$I_L = 150\text{ mA}$		4	9	mA
		$I_L = 1.5\text{ A}$		5	14	
Output Voltage Tolerance	$V_{OUT}$	$10\text{ mA} \leq I_L \leq 1.5\text{ A}$ $V_{OUT} + 1 \leq V_{IN} \leq 7.0\text{V}$	-1.5	0	+1.5	%
Line Regulation	$\Delta V_{OUT}$	$V_{OUT} + 1\text{V} < V_{IN} < 7.0\text{V}$		0.1		%
Load Regulation	$\Delta V_{OUT}$	$10\text{ mA} < I_L < 1.5\text{ A}$		1.5		%
<b>SHORT CIRCUIT PROTECTION</b>						
Short Circuit Current	$I_{SC}$			4.5		A
<b>AC PARAMETERS</b>						
Output Noise Density	$\rho_{N(f)}$	$f = 120\text{Hz}$		0.8		$\mu\text{V}$
Output Noise Voltage	eN	BW = 10Hz – 100kHz		150		$\mu\text{V(rms)}$
		BW = 300Hz – 300kHz		100		
Ripple Rejection	RR	$V_{IN} = V_{OUT} + 1.5\text{V}$ $C_{OUT} = 100\mu\text{F}$ , $V_{OUT} = 3.3\text{V}$		60		dB
		$V_{IN} = V_{OUT} + 0.3\text{V}$ $C_{OUT} = 100\mu\text{F}$ , $V_{OUT} = 3.3\text{V}$		40		
<b>OVER TEMPERATURE PROTECTION</b>						
Shutdown Threshold	$T_{SHDN}$			165		$^\circ\text{C}$
Thermal Shutdown Hysteresis	$T_{HYS}$			10		$^\circ\text{C}$

**Note:** Dropout voltage is defined as the minimum input to output differential voltage at which the output drops 2% below the nominal value. Dropout voltage specification applies only to output voltages of 2.5V and above. For output voltages below 2.5V, the drop-out voltage is nothing but the input to output differential, since the minimum input voltage is 2.5V.

## ■ TYPICAL CHARACTERISTICS

( $V_{IN}=V_{OUT}+1V$ ,  $V_{OUT}=2.5V$ ,  $C_{OUT}=33\mu F$ ,  $I_{OUT}=10mA$ ,  $C_{IN}=68\mu F$ ,  $T_a=25^\circ C$ .)

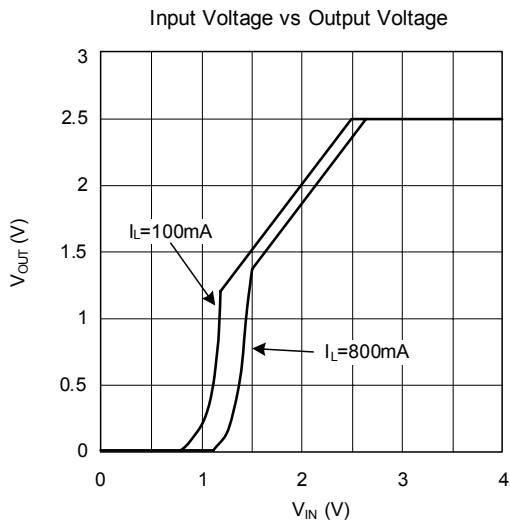
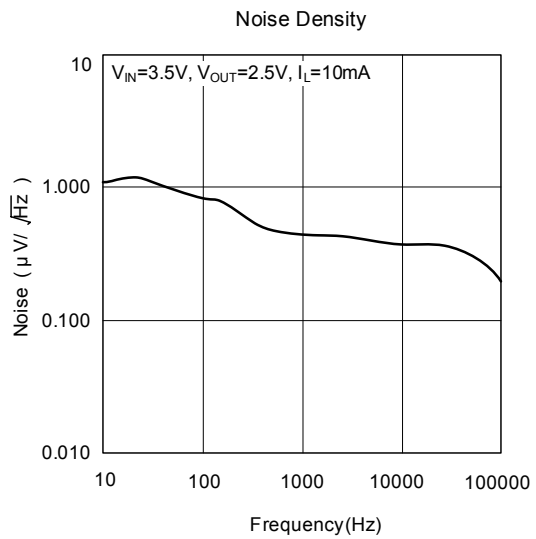
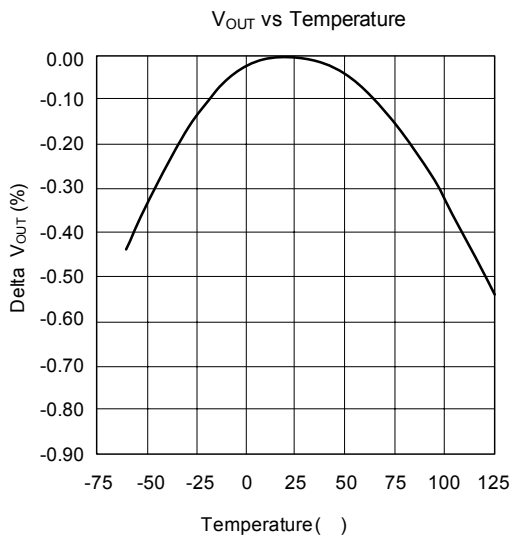
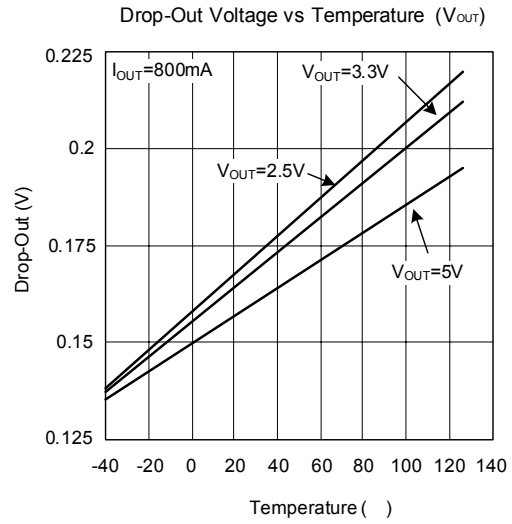
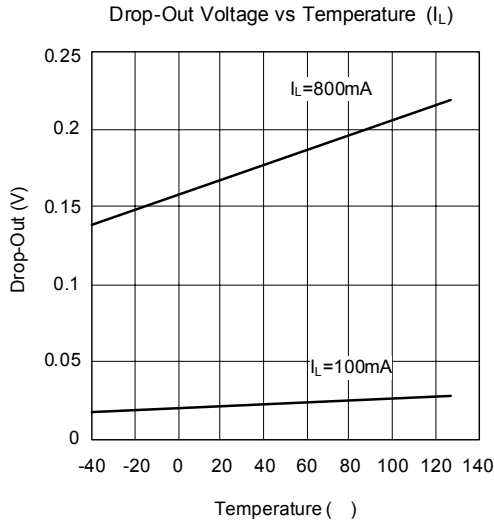

■ TYPICAL CHARACTERISTICS(Cont.)

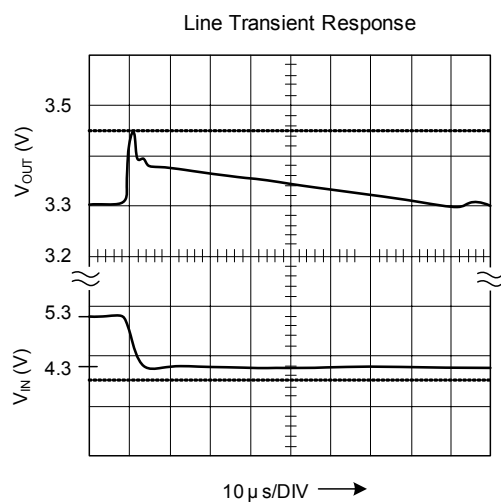
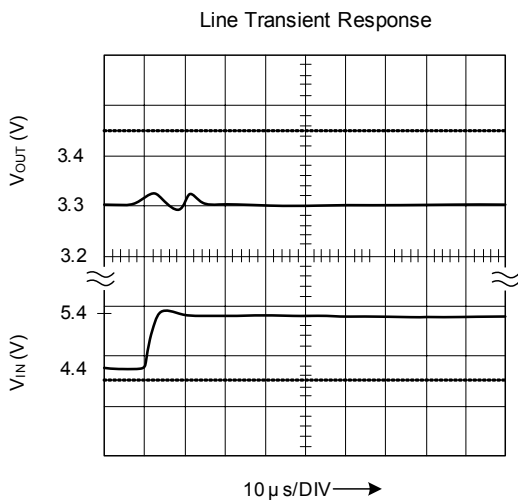
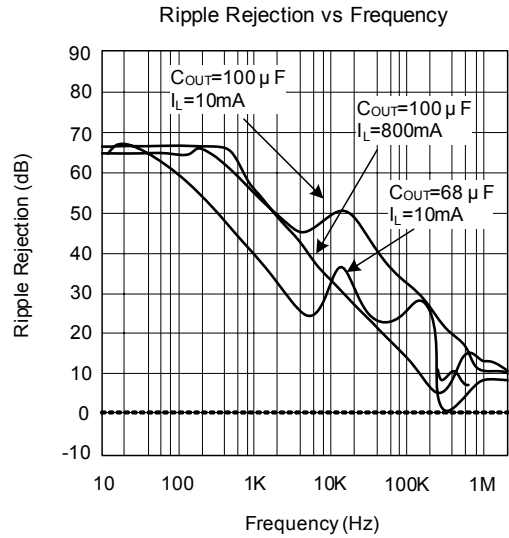
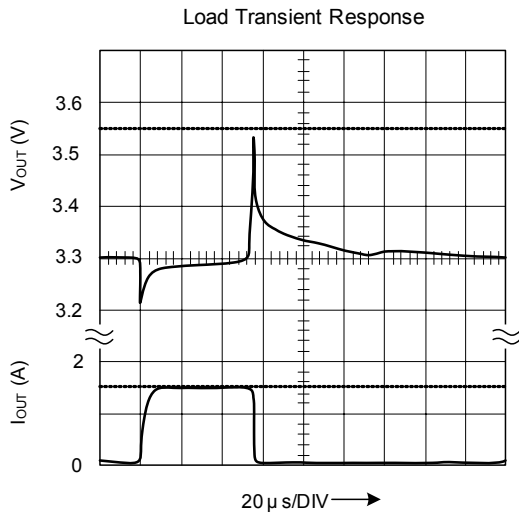
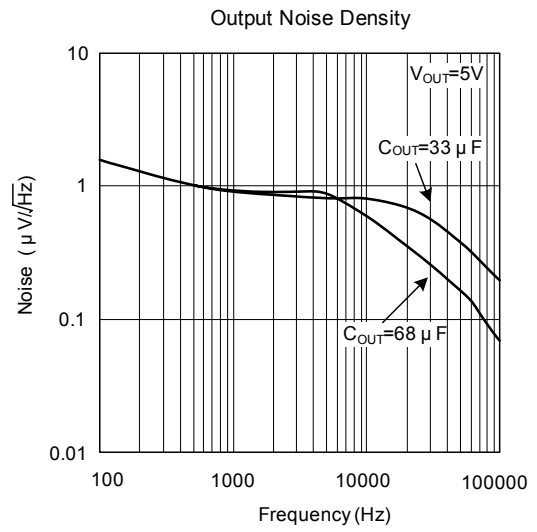
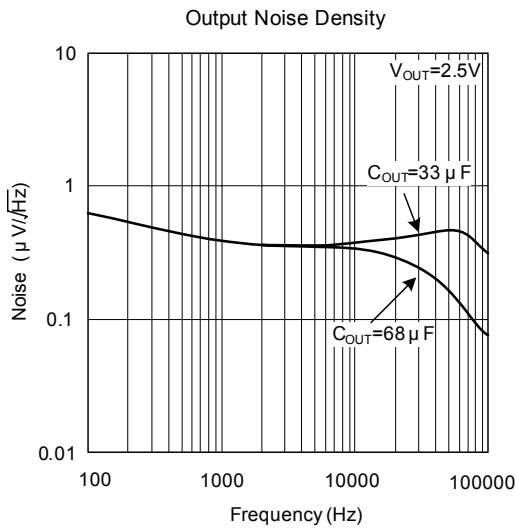

## ■ TYPICAL CHARACTERISTICS(Cont.)

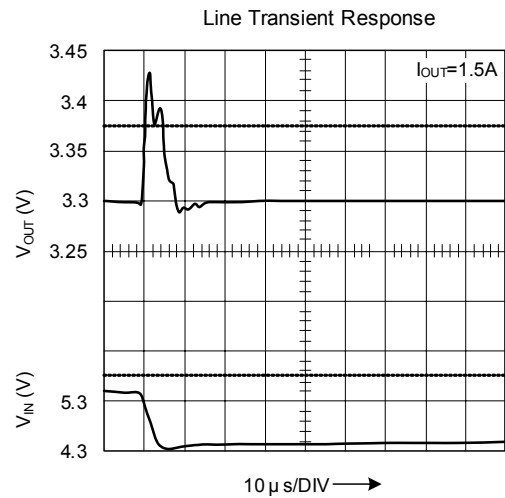
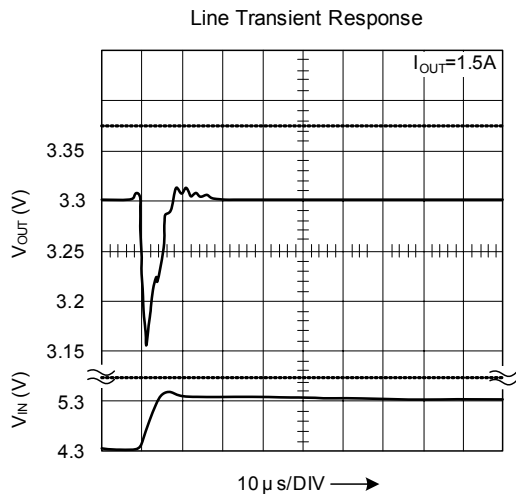

UTC assumes no responsibility for equipment failures that result from using products at values that exceed, even momentarily, rated values (such as maximum ratings, operating condition ranges, or other parameters) listed in products specifications of any and all UTC products described or contained herein. UTC products are not designed for use in life support appliances, devices or systems where malfunction of these products can be reasonably expected to result in personal injury. Reproduction in whole or in part is prohibited without the prior written consent of the copyright owner. The information presented in this document does not form part of any quotation or contract, is believed to be accurate and reliable and may be changed without notice.