

Electrical / Environmental

HM62-2610

Surface Mount Power Inductors

- Operating Temperature Range -40°C to +85°C
- Operating Frequency Up to 3MHz



Schematic



Specifications @ 25°C / Packaging

Part Number	Inductance 100kHz, 0.1Vrms @ 0 Adc		DCR Ω ± 20%	I _{rated} ⁽¹⁾ (Adc) Max.	I _{sat} ⁽²⁾ (Adc) Max.	Heating ⁽³⁾ Current (Adc) Max.	Marking Code	13" Reel Qty (Units)	Carton Box Qty (Units)
	μH	Tolerance							
HM62-26101R0NLF	1.0	± 30%	0.092	1.40	1.77	1.55	A	5,000	50,000
HM62-26102R2MLF	2.2	± 20%	0.179	1.00	1.30	1.28	D	5,000	50,000
HM62-26103R3MLF	3.3	± 20%	0.219	0.85	1.10	0.98	F	5,000	50,000
HM62-26104R7MLF	4.7	± 20%	0.282	0.70	0.95	0.86	H	5,000	50,000
HM62-26106R8MLF	6.8	± 20%	0.453	0.61	0.75	0.73	J	5,000	50,000
HM62-2610100MLF	10	± 20%	0.667	0.45	0.58	0.52	L	5,000	50,000
HM62-2610150MLF	15	± 20%	0.857	0.40	0.50	0.43	N	5,000	50,000
HM62-2610220MLF	22	± 20%	1.511	0.33	0.38	0.32	Q	5,000	50,000

- Notes: (1) The rated current (I_{rated}) is the current at which the inductance will be decreased by 10% from its initial (zero DC) value.
 (2) The saturation current (I_{sat}) is the current at which the inductance rolls off approximately 30% from its initial (zero DC) value.
 (3) The heating current is the DC current which causes the inductor temperature to increase by approximately 40°C.

Outline Dimensions (mm)

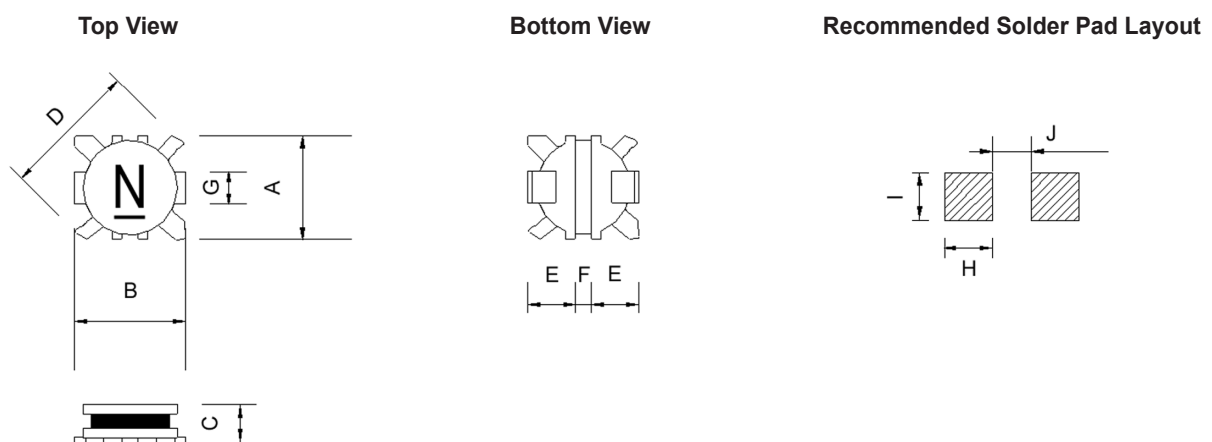

A	B	C	D	E	F	G	H	I	J
2.60 ± 0.20	2.80 ± 0.20	1.00 Max.	3.82 Max.	1.15 Ref.	0.50 Ref.	0.80 Ref.	1.2	1.2	1.0

Electrical Characteristics @ 25°C

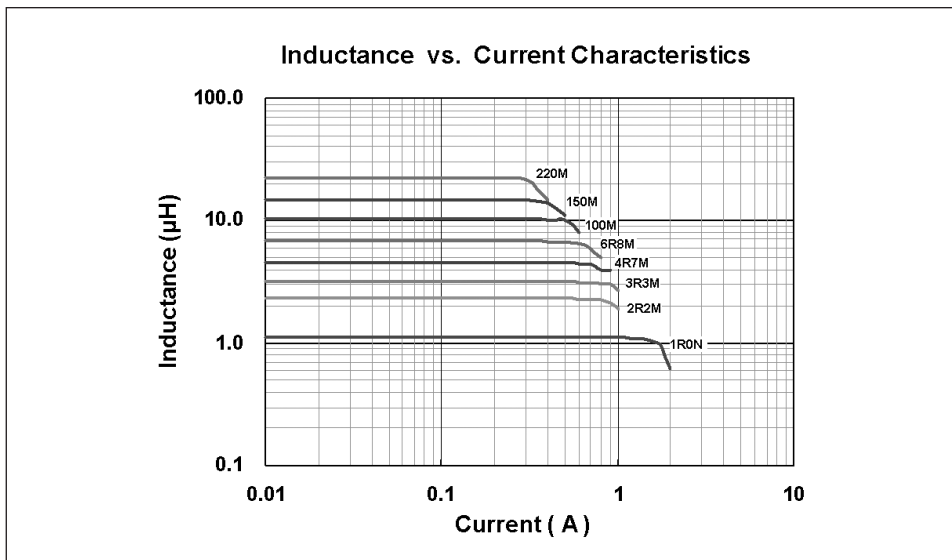
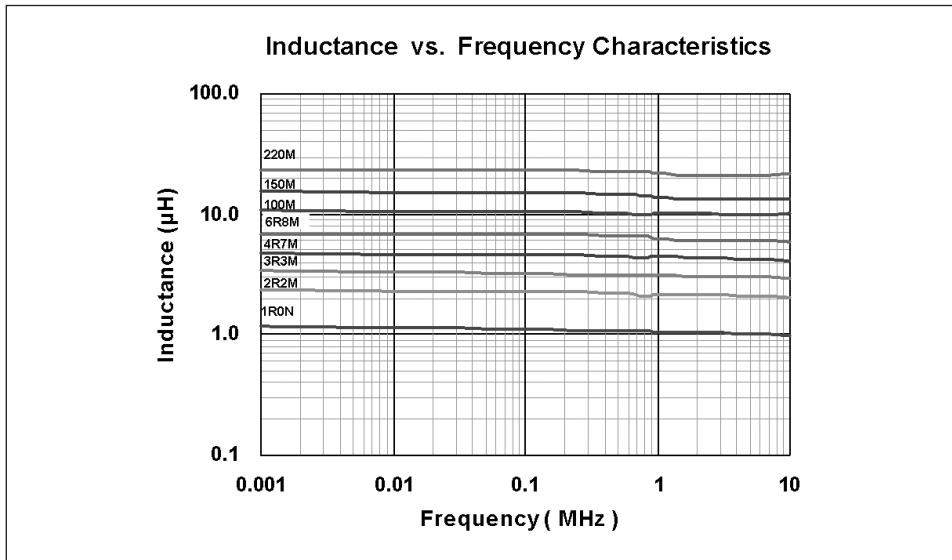

Ordering Information

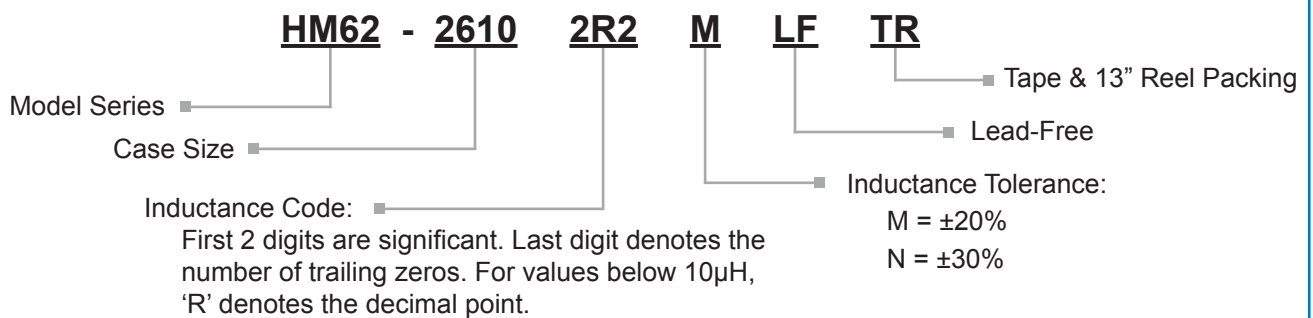

Electrical / Environmental

HM62-2815

Surface Mount Power Inductors

- Operating Temperature Range -40°C to +85°C
- Operating Frequency Up to 3MHz



Schematic



Specifications @ 25°C / Packaging

Part Number	Inductance 100kHz, 0.5Vrms @ 0 Adc		DCR Ω		I _{rated} ⁽¹⁾ (Adc)	I _{sat} ⁽²⁾ (Adc)	Heating ⁽³⁾ Current (Adc)	Marking Code	13" Reel Qty (Units)	Carton Box Qty (Units)
	μH	Tol.	Typ.	Max.	Max.	Max.	Max.			
HM62-28151R5NLF	1.5	± 30%	0.062	0.069	1.05	1.65	1.65	H1R5	4,000	40,000
HM62-28152R2MLF	2.2	± 20%	0.084	0.098	0.87	1.40	1.40	H2R2	4,000	40,000
HM62-28153R3MLF	3.3	± 20%	0.123	0.140	0.70	1.10	1.20	H3R3	4,000	40,000
HM62-28154R7MLF	4.7	± 20%	0.172	0.190	0.70	0.90	1.10	H4R7	4,000	40,000
HM62-28156R8MLF	6.8	± 20%	0.254	0.270	0.60	0.85	0.90	H6R8	4,000	40,000
HM62-2815100MLF	10	± 20%	0.386	0.410	0.42	0.68	0.75	H100	4,000	40,000
HM62-2815150MLF	15	± 20%	0.497	0.520	0.26	0.58	0.65	H150	4,000	40,000
HM62-2815220MLF	22	± 20%	0.709	0.740	0.26	0.48	0.50	H220	4,000	40,000
HM62-2815330MLF	33	± 20%	1.116	1.250	0.21	0.35	0.40	H330	4,000	40,000
HM62-2815470MLF	47	± 20%	1.835	1.980	0.20	0.30	0.30	H470	4,000	40,000

- Notes: (1) The rated current (I_{rated}) is the current at which the inductance will be decreased by 10% from its initial (zero DC) value.
 (2) The saturation current (I_{sat}) is the current at which the inductance rolls off approximately 35% from its initial (zero DC) value.
 (3) The heating current is the DC current which causes the inductor temperature to increase by approximately 40°C.

Outline Dimensions (mm)

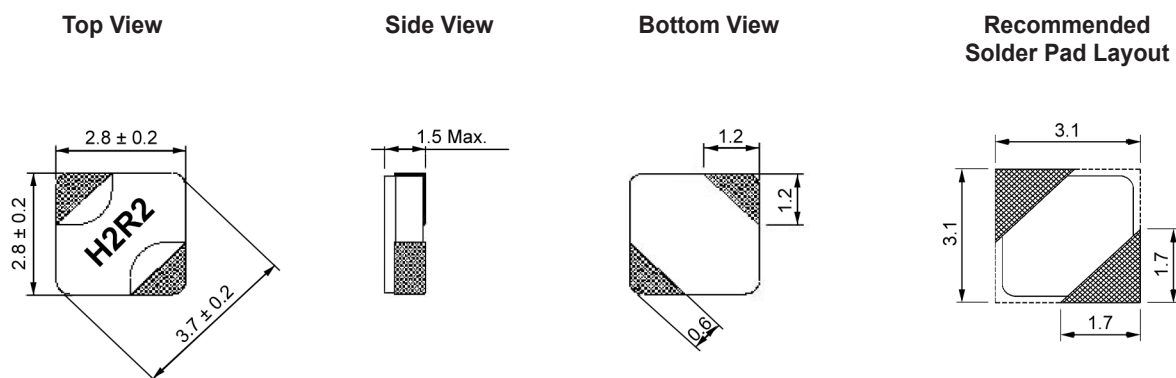

Electrical Characteristics @ 25°C

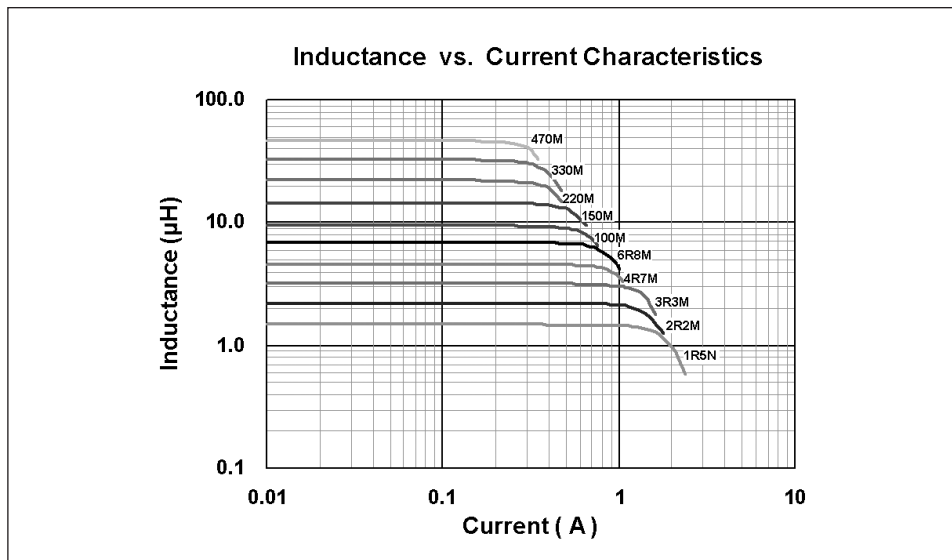
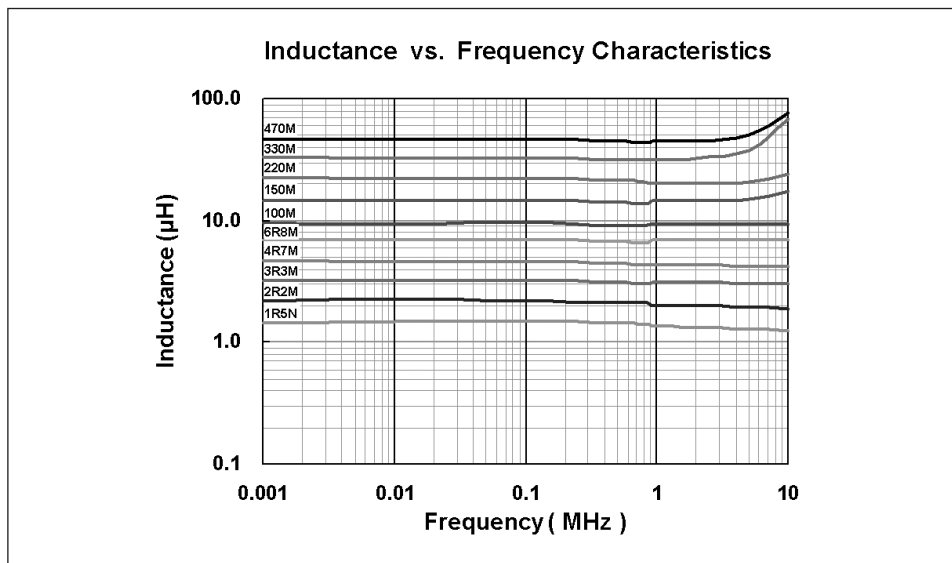

Ordering Information

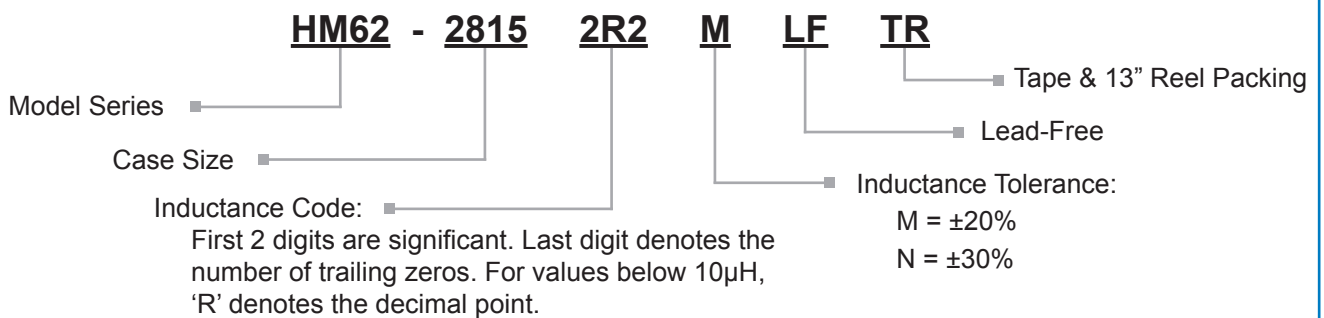

Electrical / Environmental

HM62-3214

Surface Mount Power Inductors

- Operating Temperature Range -40°C to +85°C
- Operating Frequency Up to 3MHz



Schematic



Specifications @ 25°C / Packaging

Part Number	Inductance 100kHz, 0.1Vrms @ 0 Adc		DCR Ω ±20%	I _{rated} ⁽¹⁾ (Adc) Max.	I _{sat} ⁽²⁾ (Adc) Max.	Heating ⁽³⁾ Current (Adc) Max.	Marking Code	13" Reel Qty (Units)	Carton Box Qty (Units)
	μH	Tolerance							
HM62-32141R0MLF	1.0	± 20%	0.088	2.10	3.35	1.70	A	4,000	40,000
HM62-32141R5MLF	1.5	± 20%	0.120	2.00	2.70	1.40	B	4,000	40,000
HM62-32142R2MLF	2.2	± 20%	0.153	1.60	2.30	1.30	D	4,000	40,000
HM62-32143R3MLF	3.3	± 20%	0.193	1.40	1.90	1.20	F	4,000	40,000
HM62-32144R7MLF	4.7	± 20%	0.290	1.20	1.60	0.90	H	4,000	40,000
HM62-32146R8MLF	6.8	± 20%	0.356	0.92	1.35	0.80	J	4,000	40,000
HM62-32148R2MLF	8.2	± 20%	0.495	0.90	1.20	0.65	K	4,000	40,000
HM62-3214100MLF	10	± 20%	0.547	0.80	1.05	0.60	L	4,000	40,000
HM62-3214150MLF	15	± 20%	0.696	0.68	0.92	0.55	N	4,000	40,000
HM62-3214220MLF	22	± 20%	0.942	0.56	0.75	0.45	Q	4,000	40,000
HM62-3214330MLF	33	± 20%	1.264	0.51	0.63	0.40	P	4,000	40,000
HM62-3214101MLF	100	± 20%	4.042	0.28	0.35	0.20	S	4,000	40,000

- Notes: (1) The rated current (I_{rated}) is the current at which the inductance will be decreased by 10% from its initial (zero DC) value.
 (2) The saturation current (I_{sat}) is the current at which the inductance rolls off approximately 30% from its initial (zero DC) value.
 (3) The heating current is the DC current which causes the inductor temperature to increase by approximately 40°C.

Outline Dimensions (mm)

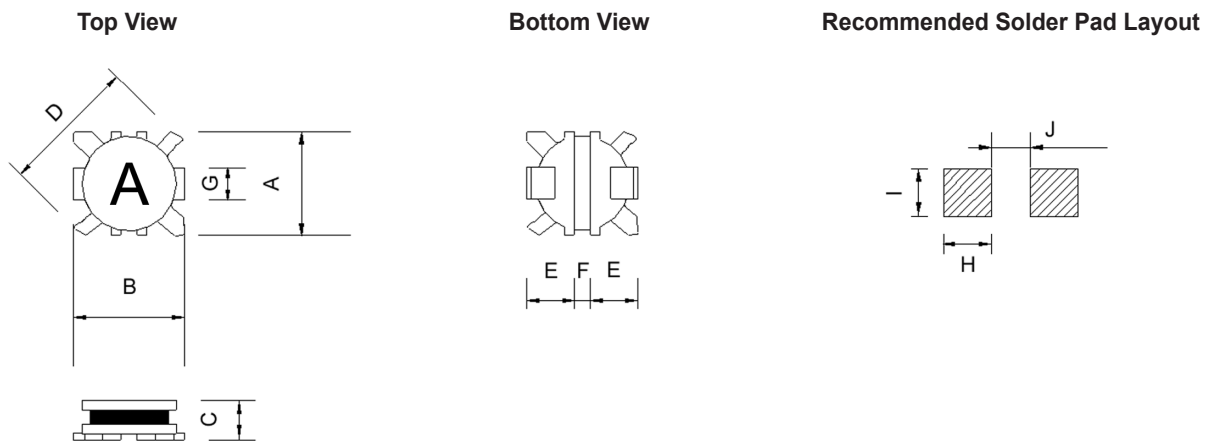

A	B	C	D	E	F	G	H	I	J
3.20 ± 0.30	3.20 ± 0.30	1.40 Max.	4.50 Max.	1.25 Ref.	0.70 Ref.	1.00 Ref.	1.2	1.4	1.4

Electrical Characteristics @ 25°C

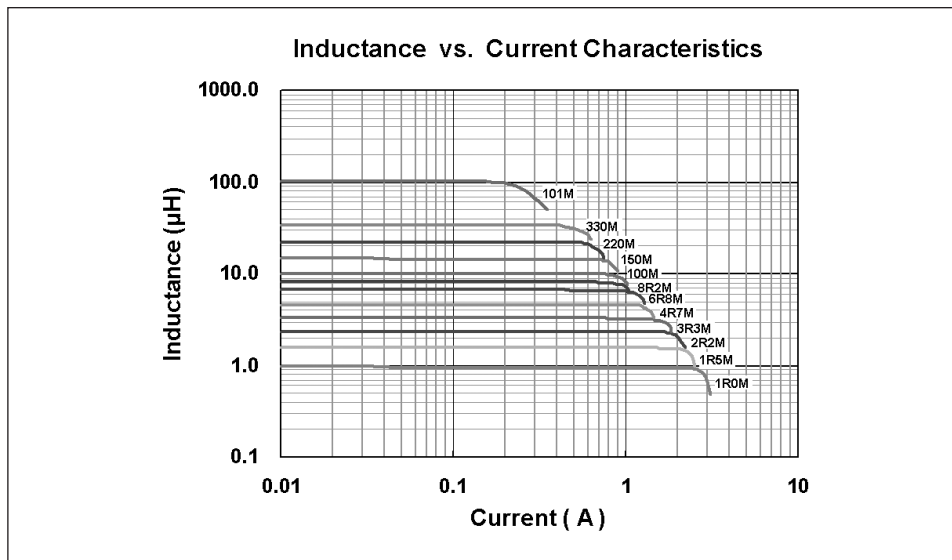
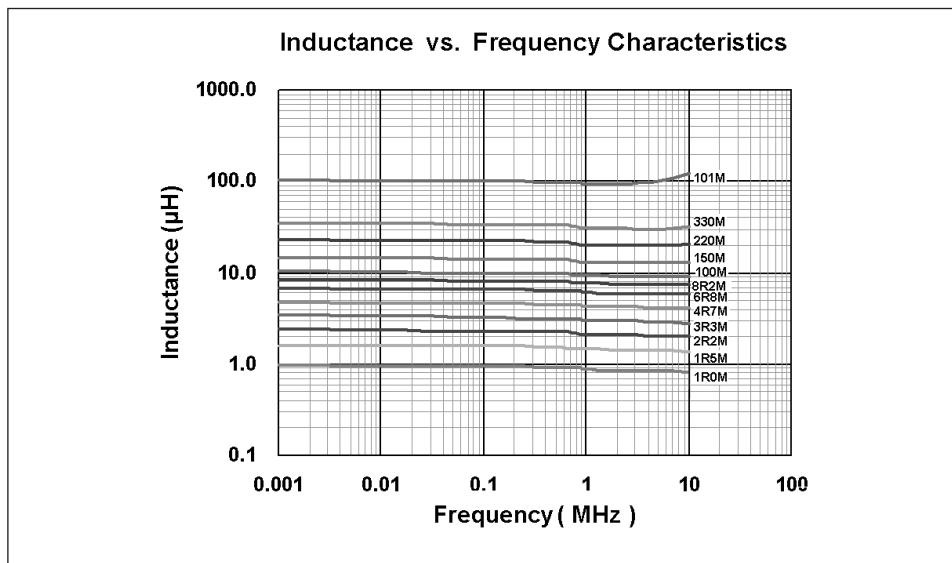

Ordering Information

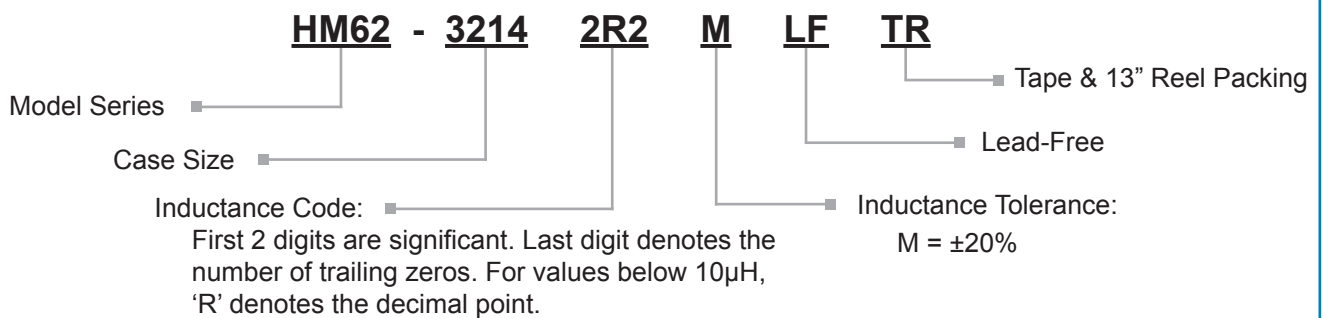

Electrical / Environmental

HM62-3715

Surface Mount Power Inductors

- Operating Temperature Range -40°C to +85°C
- Operating Frequency Up to 3MHz



Schematic



Specifications @ 25°C / Packaging

Part Number	Inductance 100kHz, 0.1Vrms @ 0 Adc		DCR Ω $\pm 20\%$	$I_{rated}^{(1)}$ (A dc) Max.	$I_{sat}^{(2)}$ (A dc) Max.	Heating ⁽³⁾ Current (A dc) Max.	Marking Code	13" Reel Qty (Units)	Carton Box Qty (Units)
	μH	Tolerance							
HM62-37152R2MLF	2.2	$\pm 20\%$	0.072	1.90	2.60	1.90	10	4,000	40,000
HM62-37153R3MLF	3.3	$\pm 20\%$	0.098	1.70	2.20	1.70	3.3	4,000	40,000
HM62-37154R7MLF	4.7	$\pm 20\%$	0.148	1.40	1.90	1.35	4.7	4,000	40,000
HM62-37156R8MLF	6.8	$\pm 20\%$	0.202	1.20	1.50	1.15	6.8	4,000	40,000
HM62-3715100MLF	10	$\pm 20\%$	0.286	0.90	1.25	0.88	10	4,000	40,000
HM62-3715150MLF	15	$\pm 20\%$	0.419	0.70	1.00	0.70	15	4,000	40,000
HM62-3715220MLF	22	$\pm 20\%$	0.622	0.60	0.85	0.60	22	4,000	40,000
HM62-3715330MLF	33	$\pm 20\%$	0.980	0.50	0.70	0.47	33	4,000	40,000
HM62-3715470MLF	47	$\pm 20\%$	1.456	0.40	0.52	0.38	47	4,000	40,000
HM62-3715221MLF	220	$\pm 20\%$	6.252	0.21	0.29	0.18	221	4,000	40,000

- Notes: (1) The rated current (I_{rated}) is the current at which the inductance will be decreased by 10% from its initial (zero DC) value.
 (2) The saturation current (I_{sat}) is the current at which the inductance rolls off approximately 30% from its initial (zero DC) value.
 (3) The heating current is the DC current which causes the inductor temperature to increase by approximately 40°C.

Outline Dimensions (mm)

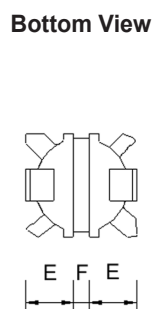
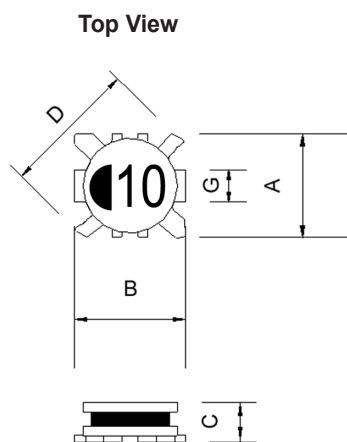

Recommended Solder Pad Layout

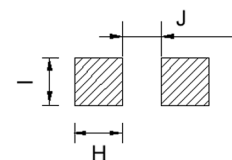

A	B	C	D	E	F	G	H	I	J
3.70 \pm 0.30	3.70 \pm 0.30	1.50 Max.	5.20 Max.	1.50 Ref.	0.70 Ref.	1.00 Ref.	1.45	1.2	1.0

Electrical Characteristics @ 25°C

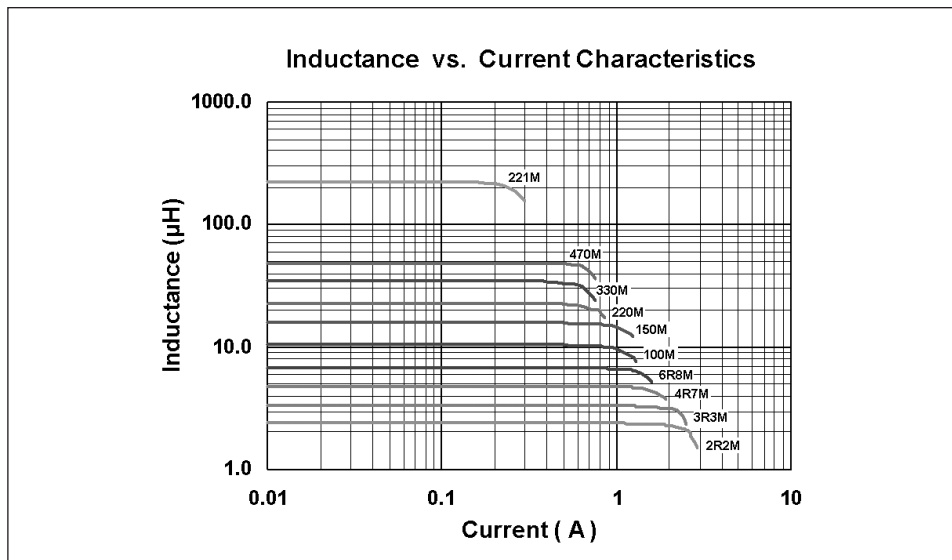
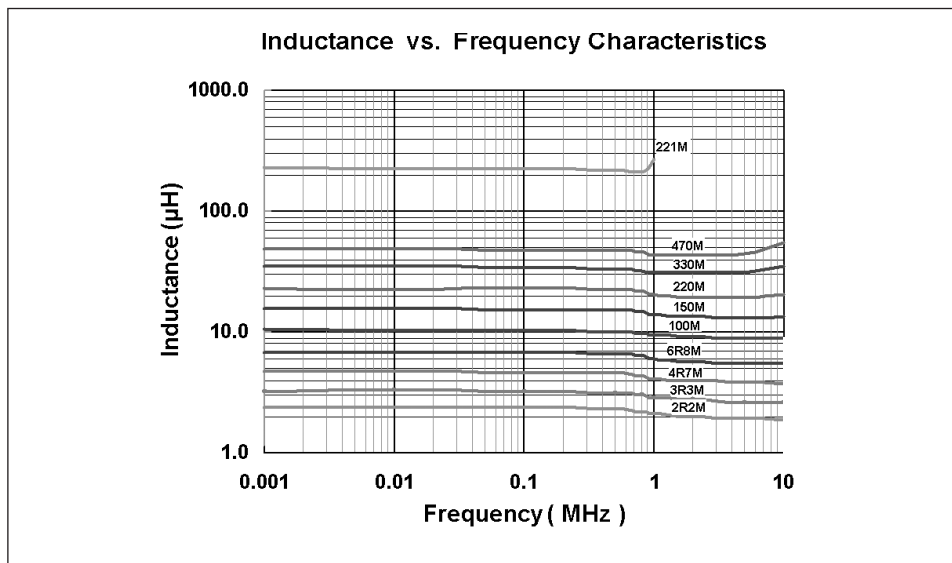

Ordering Information

