

SILICON GATE CMOS

32,768 WORD x 8 BIT CMOS PSEUDO STATIC RAM

Description

The TC51832AP is a 256K bit high speed CMOS pseudo static RAM organized as 32,768 words by 8 bits. The TC51832AP utilizes a one transistor dynamic memory cell with CMOS peripheral circuitry to provide high capacity, high speed and low power storage. The TC51832AP operates from a single 5V power supply. Refreshing is supported by a refresh (RFSH) input which enables two types of refreshing - auto refresh and self refresh. The TC51832AP features a static RAM-like interface with a write cycle in which the input data is written into the memory cell at the rising edge of R/W thus simplifying the microprocessor interface.

The TC51832AP is pin-compatible with the 256K bit CMOS static RAM JEDEC standard and is available in a 28-pin, 0.6 inch and 0.3 inch width plastic DIP, and a small outline plastic flat package.

Features

- Organization: 32,768 words x 8 bits
- Single 5V power supply
- Fast access time

	TC51832A Family		
	-70	-85	-10
t _{CEA} CE Access Time	70ns	85ns	100ns
t _{OE} OE Access Time	30ns	35ns	40ns
t _{RC} Cycle Time	115ns	135ns	160ns
Power Dissipation	385mW	303mW	248mW
Self Refresh Current	1mA/100µA		

- Auto refresh is supported by an internal refresh address counter
- Self refresh is supported by an internal timer
- Inputs and outputs TTL compatible
- Refresh: 256 refresh cycles/4ms
- Pin compatible: 256K SRAM (JEDEC)
- Package
 - TC51832AP/APL : DIP28-P-600
 - TC51832ASP/ASPL : DIP28-P-300B
 - TC51832AF/AFL : SOP28-P-450

Pin Connection (Top View)

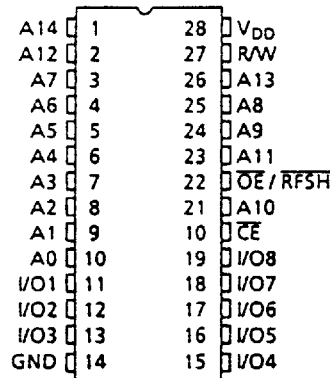

Pin Names

A0 ~ A14	Address Inputs
R/W	Read/Write Control Input
OE/RFSH	Output Enable Input Refresh Input
CE	Chip Enable Input
I/O1 ~ I/O8	Data Inputs/Outputs
V _{DD}	Power
GND	Ground

Block Diagram

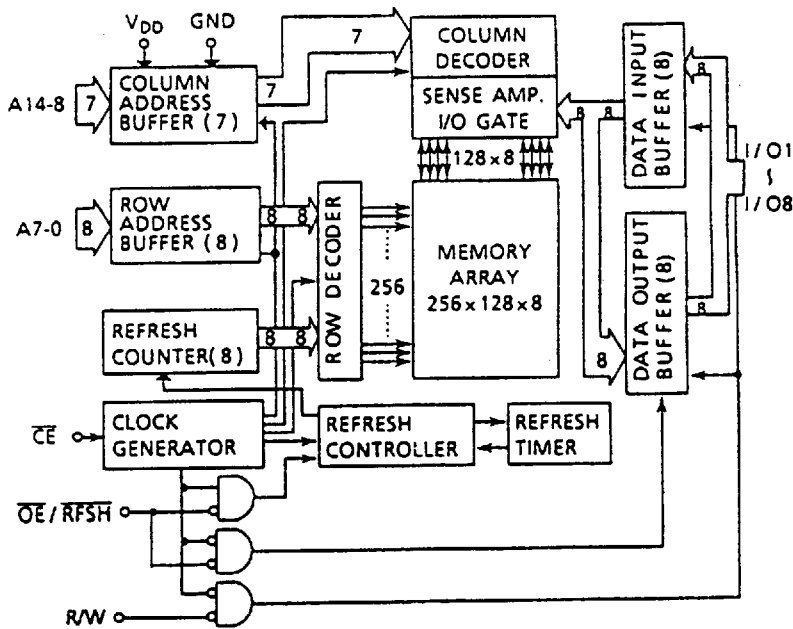

Operating Mode

MODE	PIN	\overline{CE}	$\overline{OE}/RFSH$	R/W	AD ~ A14	I/O1 - 8
Read		L	L	H	V*	OUT
Write		L	H	L	V*	IN
\overline{CE} only Refresh		L	H	H	V*	HZ
Auto/Self Refresh		H	L	*	*	HZ
Standby		H	H	*	*	HZ

H = High level input (V_{IH})

L = Low level input (V_{IL})

* = V_{IH} or V_{IL}

V* = At the falling edge of \overline{CE} , all address inputs are latched. At all other times, the address inputs are "*".

HZ = High impedance

Maximum Ratings

SYMBOL	ITEM	RATING	UNIT	NOTES
V_{IN}	Input Voltage	-1.0 ~ 7.0	V	1
V_{OUT}	Output Voltage	-1.0 ~ 7.0	V	
V_{DD}	Power Supply Voltage	-1.0 ~ 7.0	V	
T_{OPR}	Operating Temperature	0 ~ 70	°C	
T_{STRG}	Storage Temperature	-55 ~ 150	°C	
T_{SOLDER}	Soldering Temperature • Time	260 • 10	°C • sec	
P_D	Power Dissipation	600	mW	
I_{OUT}	Short Circuit Output Current	50	mA	

DC Recommended Operating Conditions

SYMBOL	PARAMETER	MIN.	TYP.	MAX.	UNIT	NOTES
V _{DD}	Power Supply Voltage	4.5	5.0	5.5	V	2
V _{IH}	Input High Voltage	2.4	—	V _{DD} + 1.0	V	
V _{IL}	Input Low Voltage	-1.0	—	0.8	V	

DC Characteristics (Ta = 0 ~ 70°C, V_{DD} = 5V±10%)

SYMBOL	PARAMETER	MIN.	TYP.	MAX.	UNIT	NOTES	
I _{DDO}	Operating Current (Average) CE, Address cycling: t _{RC} = t _{RC} min.	70ns version	—	35	70	mA	3,4
		85ns version	—	30	55		
		100ns version	—	25	45		
I _{DDs1}	Standby Current CE = V _{IH} , OE/RFSH = V _{IH}	TC1832AP/ASP/AF	—	—	1	mA	
		TC1832APL/ASPL/AFL	—	—	1		
I _{DDs2}	Standby Current CE = V _{DD} - 0.2V, OE/RFSH = V _{DD} - 0.2V	TC1832AP/ASP/AF	—	—	1	mA	
		TC1832APL/ASPL/AFL	—	—	100		
I _{DDF1}	Self Refresh Current (Average) CE = V _{IH} , OE/RFSH = V _{IL}	TC1832AP/ASP/AF	—	—	1	mA	
		TC1832APL/ASPL/AFL	—	—	1		
I _{DDF2}	Self Refresh Current (Average) CE = V _{DD} - 0.2V, OE/RFSH = 0.2V	TC1832AP/ASP/AF	—	—	1	mA	
		TC1832APL/ASPL/AFL	—	60	100		
I _{I(L)}	Input Leakage Current 0V ≤ V _{IN} ≤ V _{DD} , All other Inputs not under test = 0V	—	—	±10	μA		
I _{O(L)}	Output Leakage Current Output Disabled (CE = V _{IH} or OE/RFSH = V _{IH} or R/W = V _{IL}) 0V ≤ V _{OUT} ≤ V _{DD}	—	—	±10	μA		
V _{OH}	Output High Level I _{OH} = -1mA	2.4	—	—	V		
V _{OL}	Output Low Level I _{OL} = 2.1mA	—	—	0.4	V		

Capacitance* (V_{DD} = 5V, Ta = 25°C, f = 1MHz)

SYMBOL	PARAMETER	MIN.	MAX.	UNIT
C _{I1}	Input Capacitance (A0 - A14)	—	5	pF
C _{I2}	Input Capacitance (CE, OE/RFSH, R/W)	—	7	
C _{IO}	Input/Output Capacitance	—	7	

*This parameter is periodically sampled and is not 100% tested.

AC Characteristics (Ta = 0 ~ 70°C, V_{DD} = 5V±10%) (Notes: 5, 6, 7, 8)

SYMBOL	PARAMETER	-70		-85		-10		UNIT	NOTES
		MIN.	MAX.	MIN.	MAX.	MIN.	MAX.		
t _{RC}	Random Read, Write Cycle Time	115	-	135	-	160	-	ns	
t _{RMW}	Read Modify Write Cycle Time	175	-	190	-	220	-		
t _{CE}	\overline{CE} Pulse Width	70	10,000	85	10,000	100	10,000		
t _P	\overline{CE} Precharge Time	35	-	40	-	50	-		
t _{CEA}	\overline{CE} Access Time	-	70	-	85	-	100		
t _{OEa}	\overline{OE} Access Time	-	30	-	35	-	40		
t _{CLZ}	\overline{CE} to Output in Low -Z	20	-	20	-	20	-		
t _{OLZ}	\overline{OE} to Output in Low -Z	0	-	0	-	0	-		
t _{WLZ}	Output Active from End of Write	0	-	0	-	0	-		
t _{CHZ}	Chip Disable to Output in High-Z	0	25	0	25	0	30		9
t _{OHZ}	\overline{OE} Disable to Output in High-Z	0	25	0	25	0	30		9
t _{WHZ}	Write Enable to Output in High-Z	0	25	0	25	0	30		9
t _{OSC}	\overline{OE} Setup Time Referenced to \overline{CE}	10	-	10	-	10	-		9
t _{OHC}	\overline{OE} Hold Time Referenced to \overline{CE}	0	-	0	-	0	-		9
t _{RCS}	Read Command Setup Time	0	-	0	-	0	-		
t _{RCH}	Read Command Hold Time	0	-	0	-	0	-		
t _{WP}	Write Pulse Width	25	-	25	-	25	-		
t _{WCH}	Write Command Hold Time	40	-	40	-	40	-		
t _{CWL}	Write Command to \overline{CE} Lead Time	25	-	25	-	25	-		
t _{DSW}	Data Setup Time from R/W	20	-	20	-	20	-		10
t _{DSC}	Data Setup Time from \overline{CE}	20	-	20	-	20	-		10
t _{DHW}	Data Hold Time from R/W	0	-	0	-	0	-		10
t _{DHC}	Data Hold Time from \overline{CE}	0	-	0	-	0	-		10
t _{ASC}	Address Setup Time	0	-	0	-	0	-	11	
t _{AHC}	Address Hold Time	20	-	20	-	20	-	11	
t _{FC}	Auto Refresh Cycle Time	115	-	135	-	160	-		
t _{RFD}	\overline{RFSH} Delay Time from \overline{CE}	35	-	40	-	50	-		
t _{FAP}	\overline{RFSH} Pulse Width (Auto Refresh)	80	8,000	80	8,000	80	8,000	12	
t _{FP}	\overline{RFSH} Precharge Time	30	-	30	-	30	-	12	
t _{FAS}	\overline{RFSH} Pulse Width (Self Refresh)	8,000	-	8,000	-	8,000	-	12	
t _{FRS}	\overline{CE} Delay Time from \overline{RFSH} (Self Refresh)	115	-	135	-	160	-	12	
t _{REF}	Refresh Period (256 cycles, A0 ~ A7)	-	4	-	4	-	4	ms	
t _T	Transition Time (Rise and Fall)	3	50	3	50	3	50	ns	

Notes:

- 1) Stress greater than those listed under "Maximum Ratings" may cause permanent damage to the device.
- 2) All voltages are referenced to GND.
- 3) I_{DD0} depends on the cycle time.
- 4) I_{DD0} depends on the output loading. Specified values are obtained with the outputs open.
- 5) An initial pause of 100 μ s with high \overline{CE} is required after power-up before proper device operation is achieved.
- 6) AC measurements assume $t_f = 5$ ns.

7) Timing reference levels

Input Levels	:	$V_{IH} = 2.6V$ $V_{IL} = 0.6V$
Input Reference Levels	:	$V_{IH} = 2.4V$ $V_{IL} = 0.8V$
Output Reference Levels	:	$V_{OH} = 2.2V$ $V_{OL} = 0.8V$

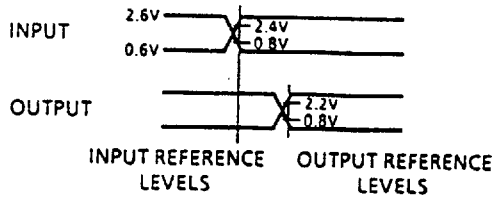

- 8) Measured with a load equivalent to 1 TTL load and 100pF.
- 9) t_{CHZ} , t_{OHZ} , t_{WHZ} define the time at which the output achieves the open circuit condition and is not referenced to output voltage levels.
- 10) For write cycles, the input data is latched at the earlier of R/W or \overline{CE} rising edge. Therefore, the input data must be valid during the setup time (t_{DSW} or t_{DSC}) and hold time (t_{DHW} or t_{DHC}).
- 11) All address inputs are latched at the falling edge of \overline{CE} . Therefore, all the address inputs must be valid during t_{ASC} and t_{AHC} .
- 12) The two refresh operations, auto refresh and self refresh, are defined by the \overline{RFSH} pulse width under the condition $\overline{CE} = V_{IH}$.
 Auto refresh : \overline{RFSH} pulse width $\leq t_{FAP}$ (max.)
 Self refresh : \overline{RFSH} pulse width $\geq t_{FAS}$ (min.)

The timing parameter t_{FRS} must be met for proper device operation under the following conditions:

- after self refresh
- if $\overline{RFSH} = "L"$ after power-up

Timing Waveforms

Read Cycle

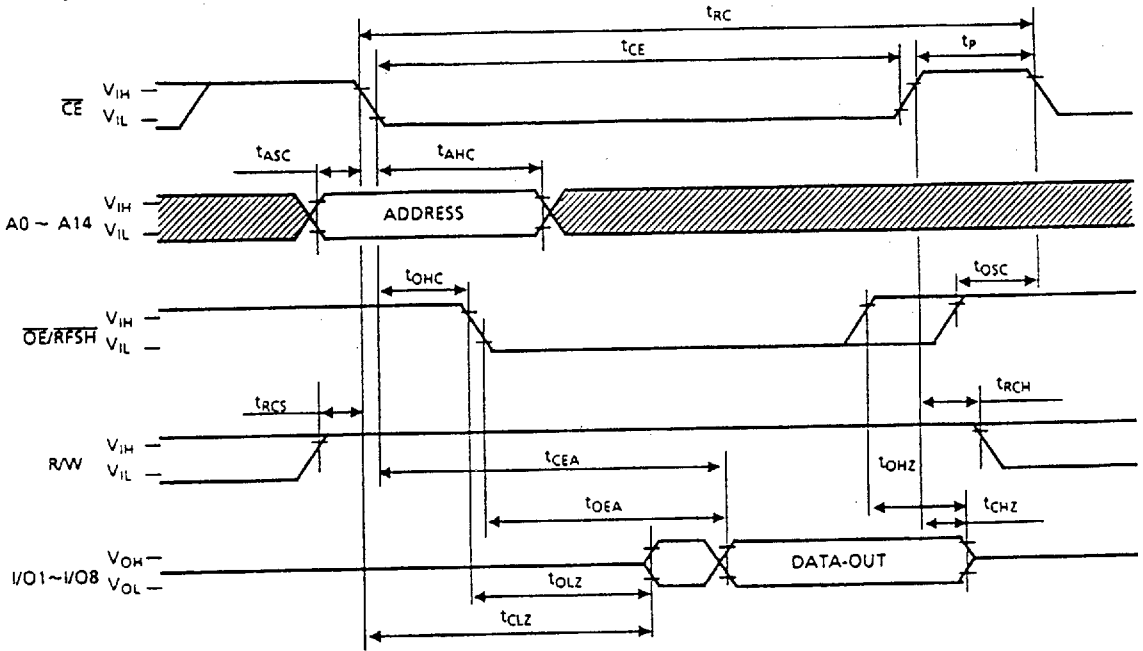

Read Modify Write Cycle

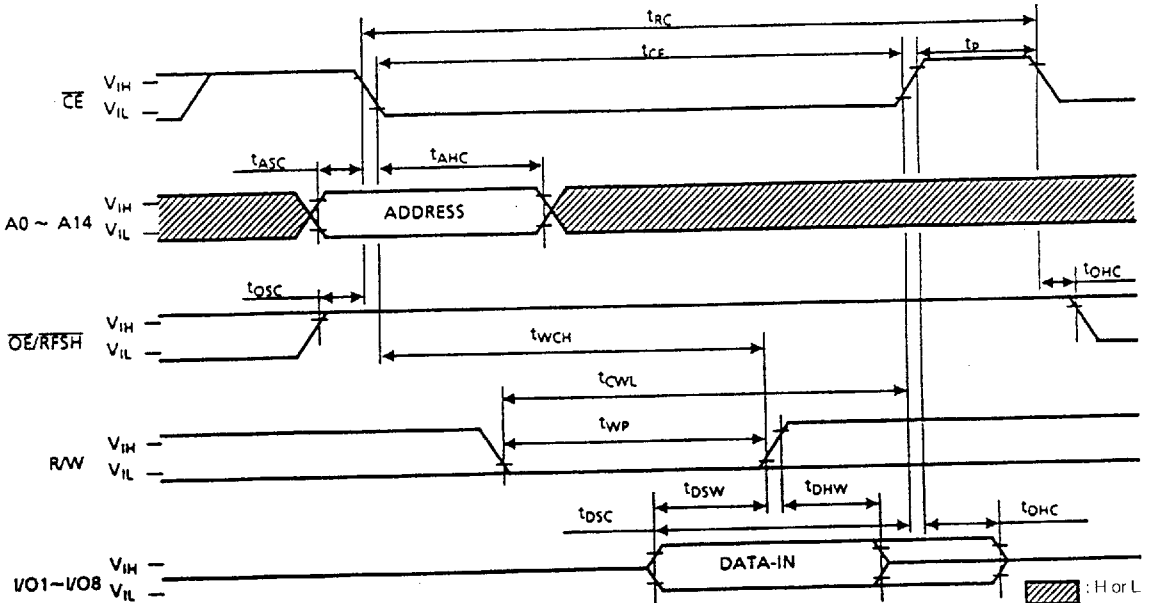

Write Cycle 2 (OE Clocked)

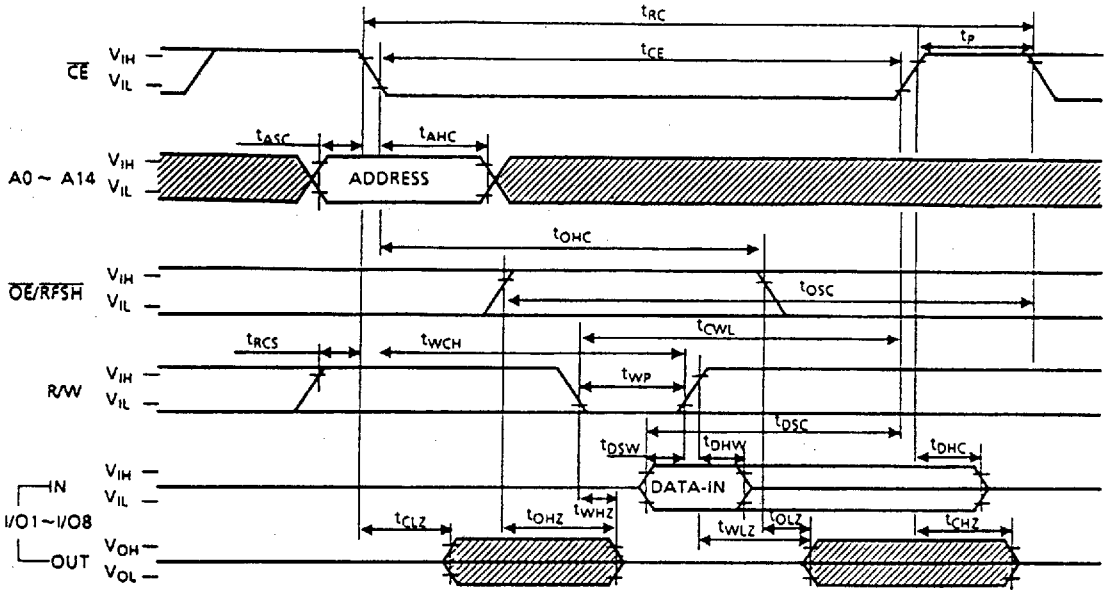

Read Modify Write Cycle

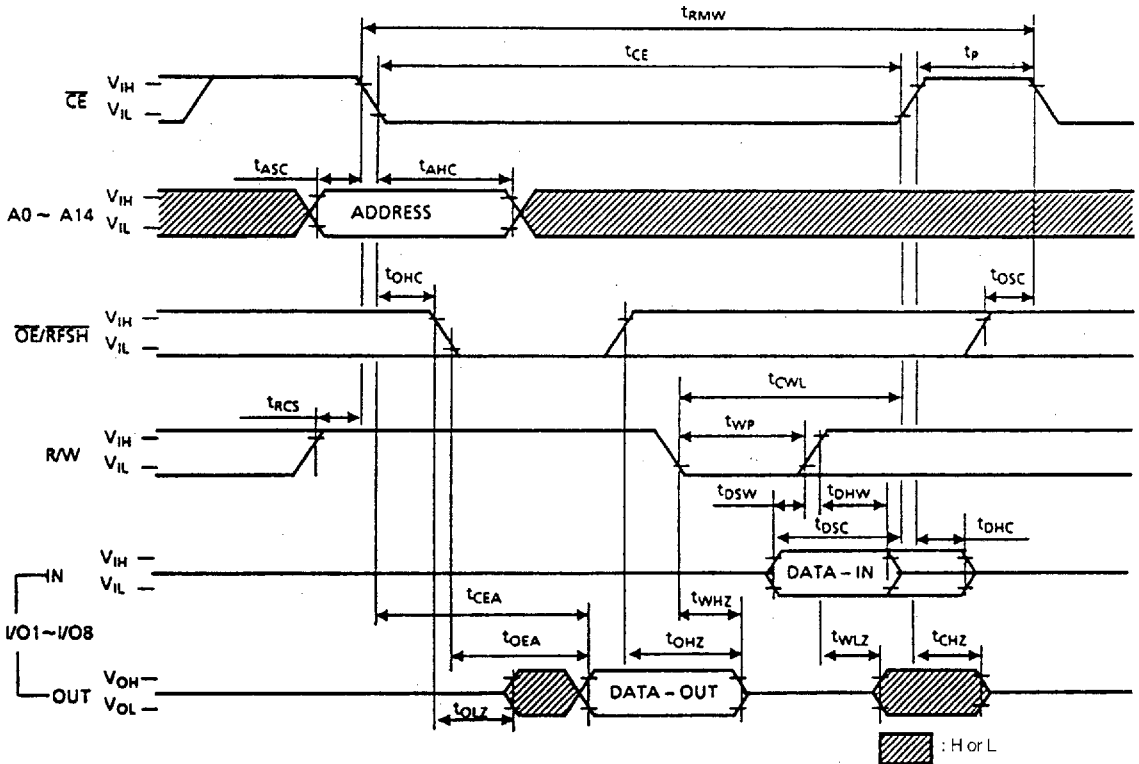

CE Only Refresh

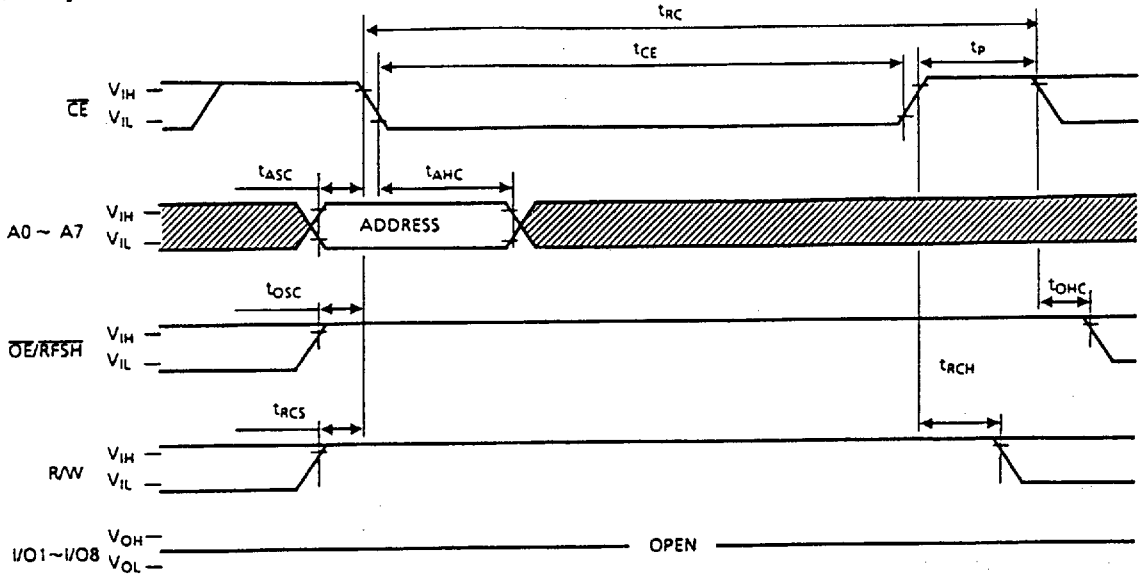

Note: $A_8 \sim A_{14} = V_{IH}$ or V_{IL}

▨ : H or L

Auto Refresh

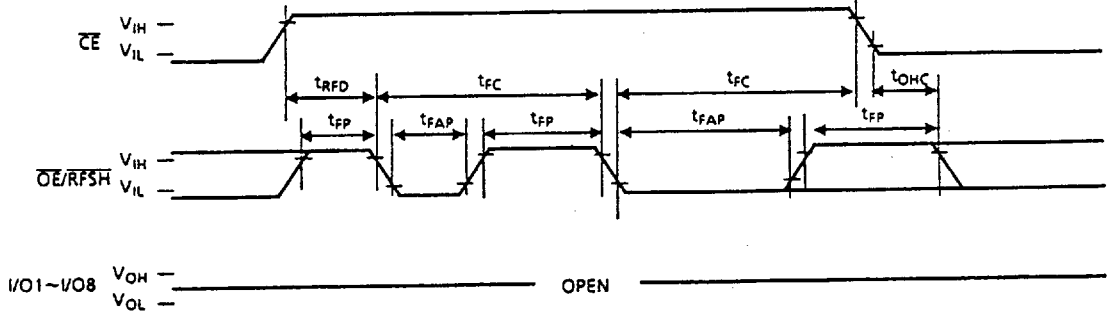

Note: $R/W, A_0 \sim A_{14} = V_{IH}$ or V_{IL}

Self Refresh

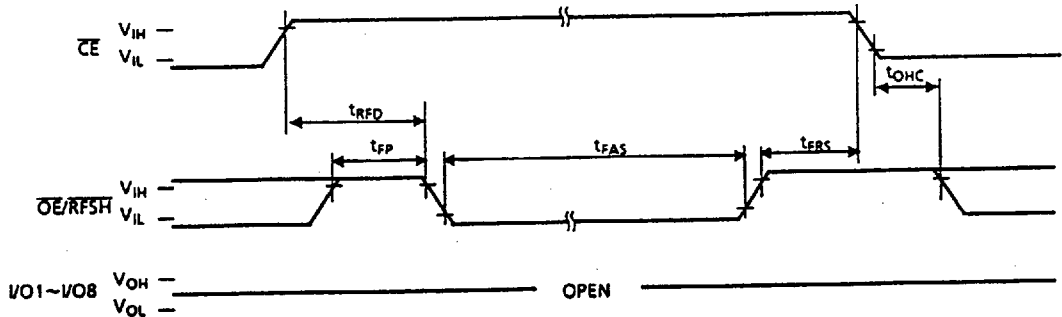

Note: $R/W, A_0 \sim A_{14} = V_{IH}$ or V_{IL}