

SURFACE MOUNT LED LAMPS

5630 Package Power Warm White Surface Mount Device

Part Number: 62-217BSW1C1

Package outlines & Re-flow Profile

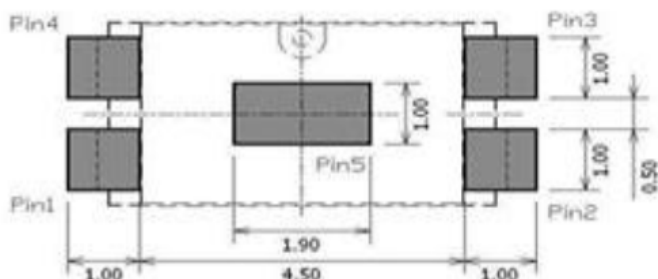
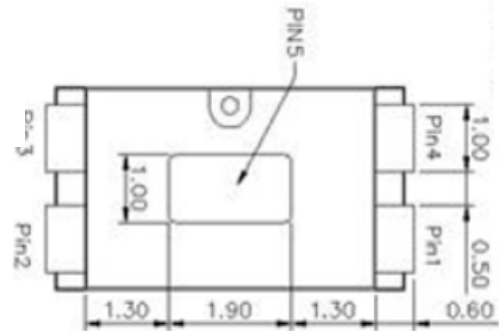
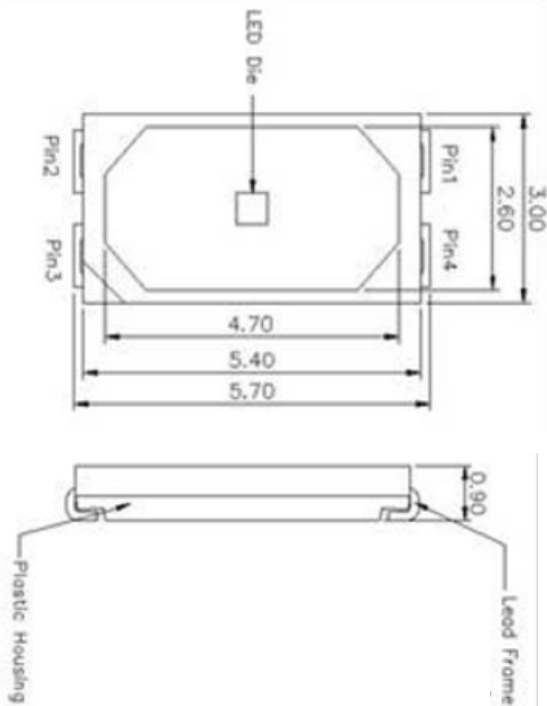

Reflow Temp/Time

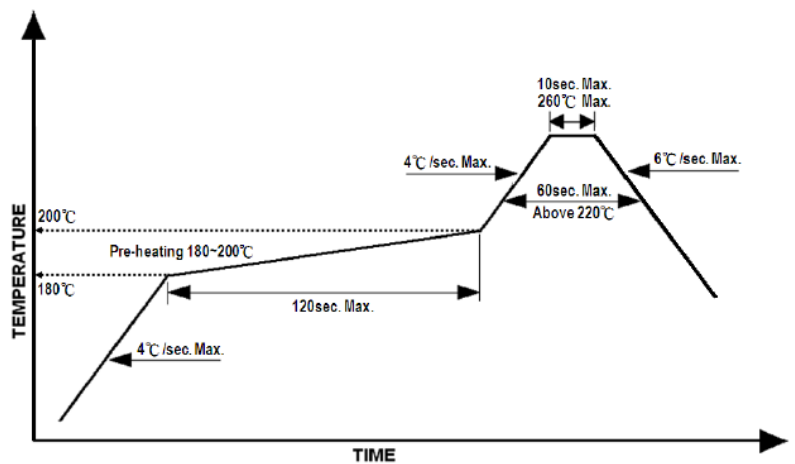

Soldering iron

Basic spec is $\leq 5\text{sec}$ when 260°C . If temperature is higher, time should be shorter ($+10^\circ\text{C} \rightarrow -1\text{sec}$). Power dissipation of iron should be smaller than 15W, and temperatures should be controllable. Surface temperature of the device should be under 230°C .

ITEM	MATERIALS
Resin (mold)	Epoxy
Lens color	Yellow Diffused
Printed circuit board	BT
Emitted color	Warm White
Material	InGaN

NOTES:

1. All dimensions are in millimeters (inches);
2. Tolerances are $\pm 0.1\text{mm}$ (0.004inch) unless otherwise noted.
3. Polarity referring onto the cathode mark is reversed on the red.

**A-BRIGHT INDUSTRIAL CO., LTD.****SURFACE MOUNT LED LAMPS**

Part Number: 62-217BSW1C1

ELECTRO-OPTICAL CHARACTERISTICS**(T_A=25°C)**

Parameter	Test Condition	Symbol	Value			Unit
			MIN.	TYP.	MAX.	
Viewing angle at 50% I _v	I _F =60mA	2θ 1/2	120			Deg
Forward voltage	I _F =60mA	V _F	2.8	---	3.5	V
Color Temperature	I _F =60mA	CCT	2750	3000	3250	K
Luminous Flux	I _F =60mA	Flux	---	19	---	lm
Pulse Forward Current (Pulse Width ≤ 10msec, and duty ≤ 1/10)		I _{FP}	150			mA

Absolute maximum ratings**(T_A=25°C)**

Parameter	Symbol	Value	Unit
Forward current	I _F	100	mA
Reverse voltage	V _R	5	V
Reverse current	I _R	1	μA
Power dissipation	P _D	235	mW
Operating temperature range	Top	-30 ~+80	°C
Storage temperature range	Tstg	-40 ~+85	°C



A-BRIGHT INDUSTRIAL CO., LTD.

SURFACE MOUNT LED LAMPS

Part Number: 62-217BSW1C1

Bin Code

■ Iv Bin:

Color	Bin Code	Spec. Range
White	MC2	15.8~18.1lm
	MD2	16.9 ~18.1lm
	NA1	18.1~19.3lm
	NB1	19.3~20.6lm
	NC2	20.6~22.0lm
	ND2	22.0~23.5lm
	AP1	23.4~25.1lm
	BP1	25.1~26.8m
	CP2	26.8~28.6m
	DP2	28.6~30.4m
	QA1	30.4~32.6m
	QB1	32.6~34.9m
	QC2	34.9~37.2m
	QD2	37.2~39.8m
	RA1	39.8~42.5m
	RB1	42.5~45.3m
	RC2	45.3~48.4m
	RD2	48.4~51.7m
	SA3	51.7~55.2m
	SB3	55.2~58.9m
SC4	58.9~62.4m	
SD4	62.4~67.2m	

■ Vf Bin

Bin Code	Spec. Range
H1	2.8-2.9V
H2	2.9-3.0V
H3	3.0-3.1V
H4	3.1-3.2V
J1	3.2-3.3V
J2	3.3-3.4V
J3	3.4-3.5V

Forward Voltage Measurement Allowance is $\pm 0.005V$

Luminous Intensity Measurement Allowance is $\pm 7\%$

Color Temperature		Iv Bin		
Min.	Max.	Min.	Typ.	Max.
2750K	3250K	MD2	NA1	NB1
3750K	4250K	NB1	NC2	ND2
5250K	6250K	NA1	NB1	NC2



A-BRIGHT INDUSTRIAL CO., LTD.

SURFACE MOUNT LED LAMPS

Part Number: 62-217BSW1C1

Color Rank

800K-8600K	800K-8600K	800K-8600K	800K-8600K	800K-8600K	800K-8600K	800K-8600K	800K-8600K	800K-8600K	800K-8600K	800K-8600K	800K-8600K	800K-8600K	800K-8600K	800K-8600K	800K-8600K	800K-8600K	800K-8600K
x	y	x	y	x	y	x	y	x	y	x	y	x	y	x	y	x	y
0.298	0.282	0.2915	0.298	0.302	0.297	0.29825	0.3045	0.2943	0.29	0.28125	0.30893	0.295125	0.29675	0.29225	0.315585	0.29348	0.29585
0.2948	0.29	0.28725	0.30883	0.298125	0.29575	0.29235	0.315585	0.2918	0.298	0.283	0.31925	0.29815	0.3015	0.295	0.33893	0.29225	0.29585
0.299125	0.29575	0.292925	0.315585	0.3035	0.3015	0.298	0.3025	0.29825	0.3045	0.298	0.30893	0.295125	0.29675	0.29225	0.315585	0.29348	0.29585
0.302	0.287	0.29625	0.3045	0.308	0.292	0.301	0.311	0.295125	0.29575	0.29225	0.315585	0.295125	0.29675	0.29225	0.315585	0.29348	0.29585
0.298	0.282	0.2915	0.298	0.302	0.297	0.29825	0.3045	0.2943	0.29	0.28125	0.30893	0.295125	0.29675	0.29225	0.315585	0.29348	0.29585

Note: It maintains a tolerance of x, y ±0.005

A-BRIGHT A-BRIGHT INDUSTRIAL CO., LTD. SURFACE MOUNT LED LAMPS

Part Number: 62-217BSW1C1

CIE Chromaticity Diagram

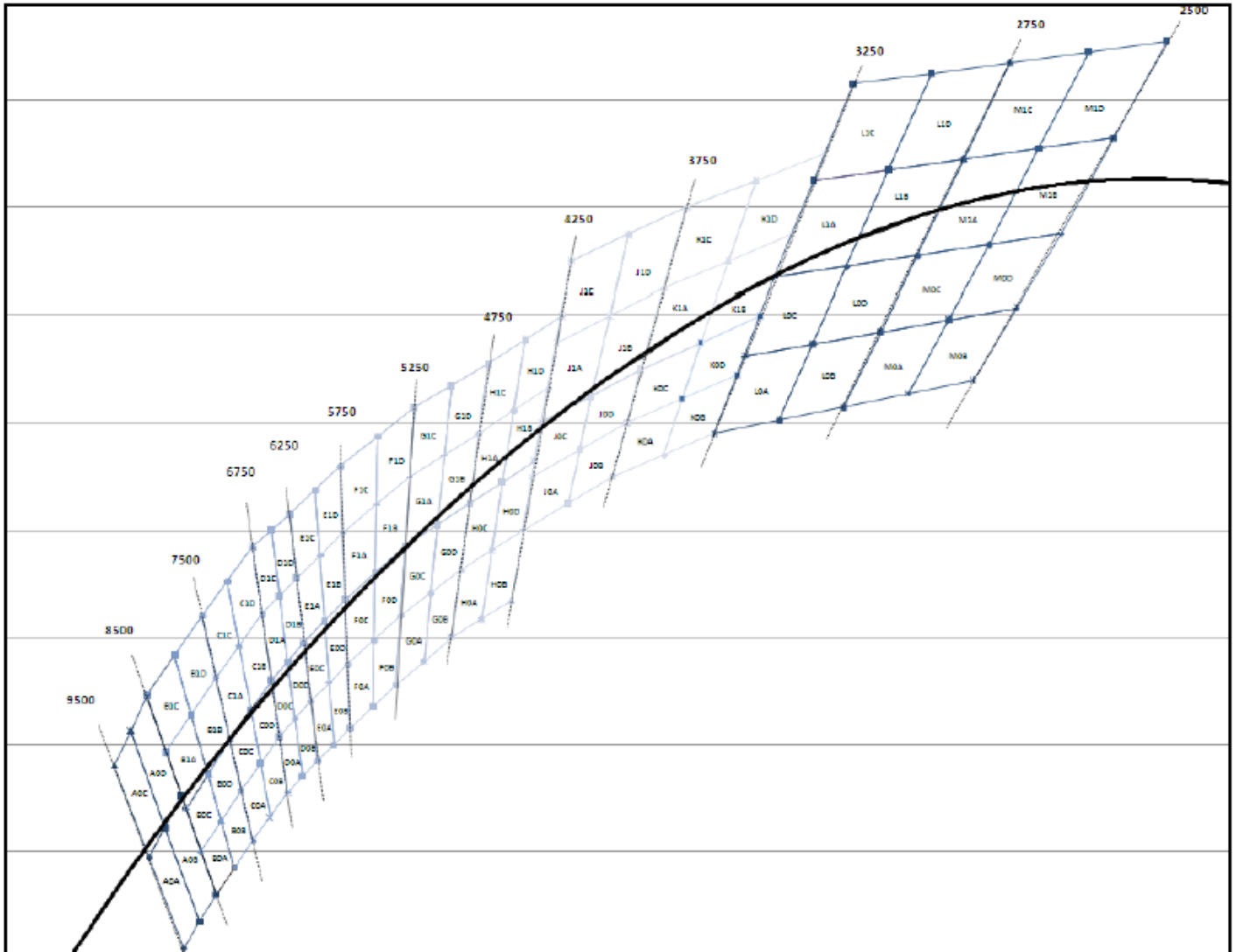

SURFACE MOUNT LED LAMPS

Part Number: 62-217BSW1C1

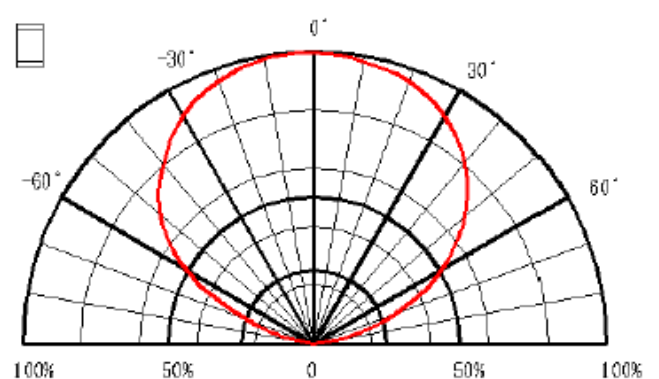
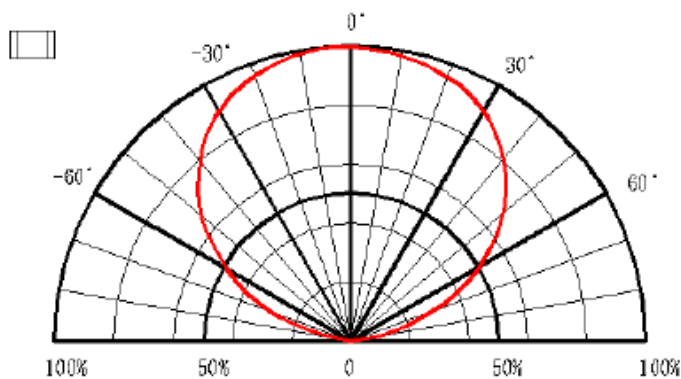
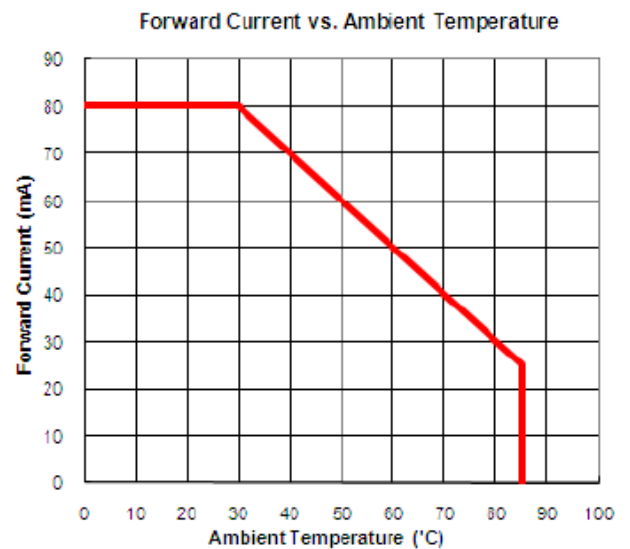
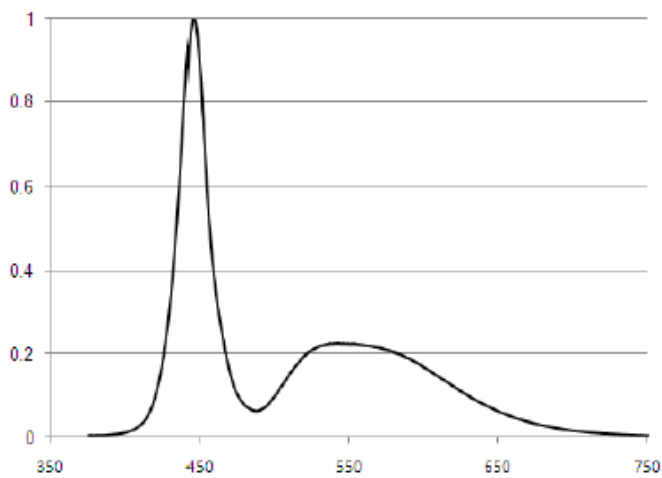
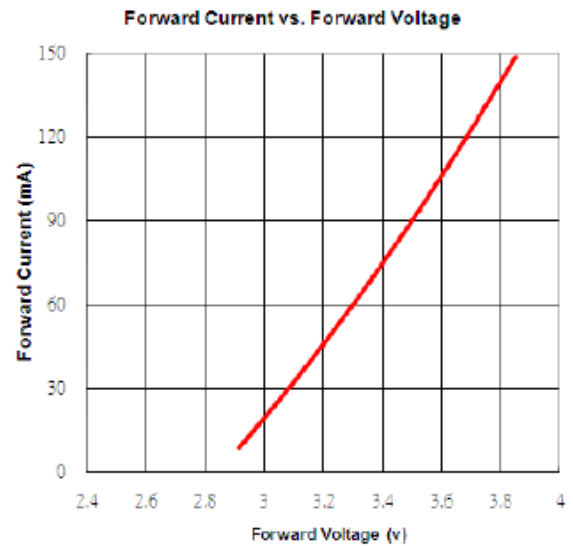
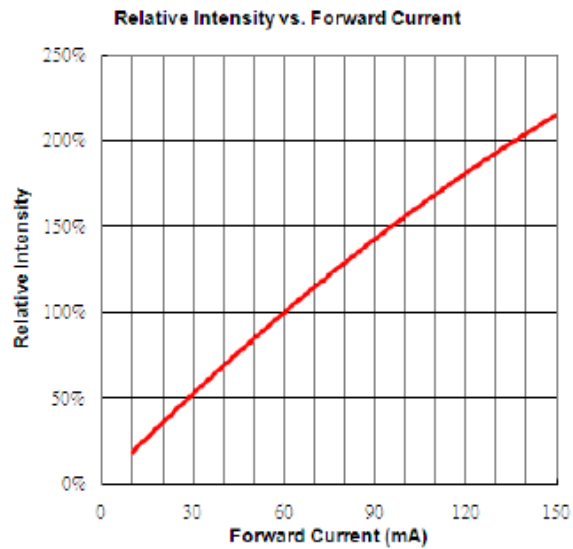
Typical Electro-Optical Characteristic Curves

A-BRIGHT A-BRIGHT INDUSTRIAL CO., LTD. SURFACE MOUNT LED LAMPS

Part Number: 62-217BSW1C1

Packaging Tape, Reel, and Packing Model

Tape Dimension

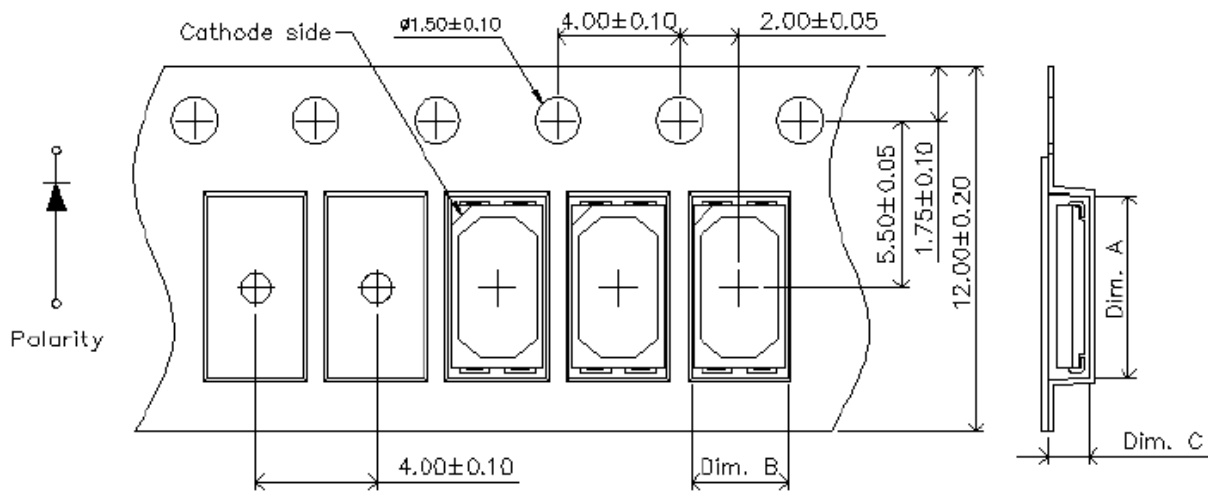

Part No.	Dim. A	Dim. B	Dim. C	Q'ty/Reel
HT-T5301	6.0 ± 0.1	3.2 ± 0.1	1.1 ± 0.1	2K

Unit: mm

Reel Dimension

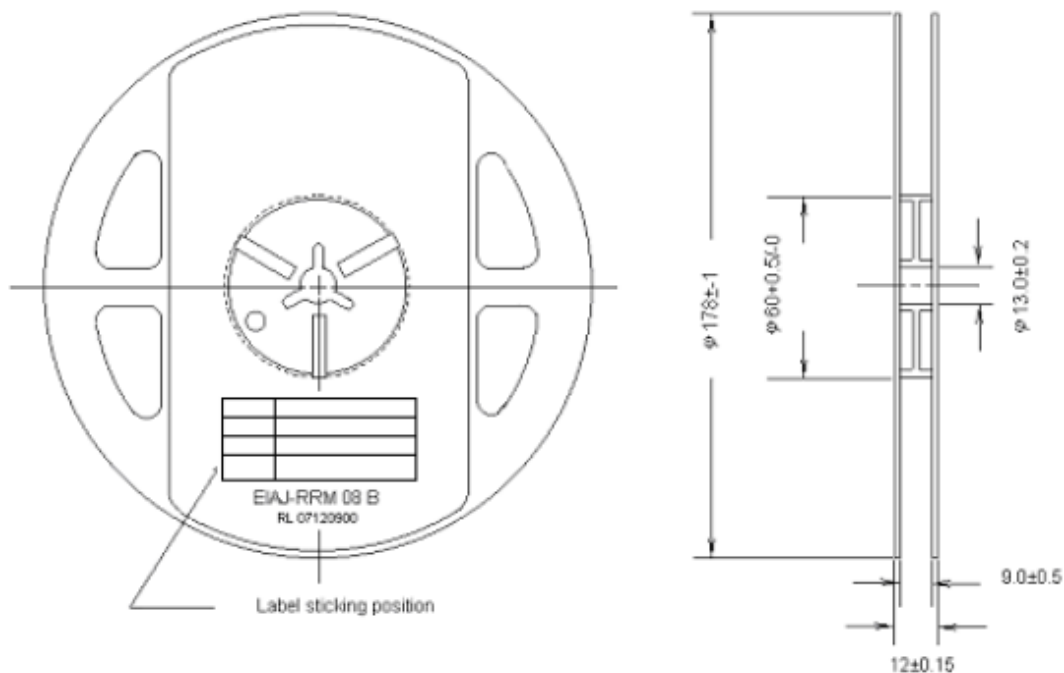

SURFACE MOUNT LED LAMPS

Part Number: 62-217BSW1C1

Precautions For Use

1. Over-current proof

Customer must apply resistors for protection, otherwise slight voltage shift will cause big current change (Burn out will happen).

2. Storage

2.1 Do not open moisture proof bag before the products are ready to use.

2.2 Before opening the package, the LEDs should be kept at 30°C or less and 90%RH or less.

2.3 The LEDs should be used within a year.

2.4 After opening the package, the LEDs should be kept at 30°C or less and 70%RH or less.

2.5 The LEDs should be used within 168 hours (7 days) after opening the package.

2.6 If the moisture absorbent material (silica gel) has faded away or the LEDs have exceeded the storage time, baking treatment should be performed using the following conditions.

Baking treatment : 60±5°C for 24 hours.

3. Soldering Condition

3.1 Pb-free solder temperature profile

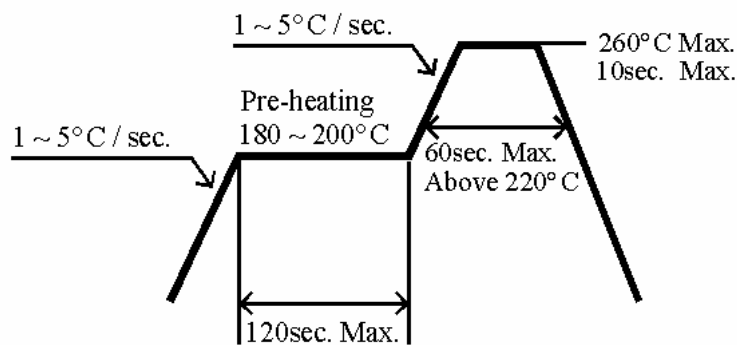

3.2 Reflow soldering should not be done more than two times.

3.3 When soldering, do not put stress on the LEDs during heating.

3.4 After soldering, do not warp the circuit board.

4. Soldering Iron

Each terminal is to go to the tip of soldering iron temperature less than 280°C for 3 seconds within once in less than soldering iron capacity 25W. Leave two seconds and more intervals, and do soldering of each terminal. Be careful because the damage of the product is often started at the time of the hand solder.