

**BI-DIRECTIONAL
TRIGGER DIODES**
DO-35 玻壳封装双向触发二极管
DO-35 GLASS-SEALED BI-DIRECTIONAL TRIGGER DIODES

符号 Symbol	参数 Parameter	测试条件 Test Condition	型号 Type	Min	Typ	Max	Unit	外型尺寸 Package (单位: mm)
V_{BO}	击穿电压 Breakdown Voltage	见图 1 See Fig 1	DB-3 DB-4 DB-6	28 35 56	32 40 60	36 45 70	V	 <p>DO-35 (mm)</p>
$ +V_{BO} - -V_{BO} $	击穿电压对称性 Breakover Voltage Symmetry	见图 1 See Fig 1	DB-3 DB-4 DB-6			3 3 4	V	
$ \pm \Delta V $	动态回弹电压 Dynamic Breakback Voltage	$\Delta I = I_{BO} \text{ to } I_F = 10\text{mA}$ 见图 1 See Fig 1	DB-3 DB-4 DB-6	5 5 10			V	
V_O	输出电压 Output Voltage	见图 2 See Fig 2		5			V	
I_{BO}	击穿电流 Breakdown Current					100	μA	
t_r	上升时间 Rise Time	见图 3 See Fig 3			1.5		μs	
I_B	漏电流 Leakage Current	$V_m = 0.5V_{BO}(\text{Max})$ 见图 1 See Fig 1				10	μA	

极限参数
LIMITING VALUES

符号 Symbol	参数 Parameter	Value	Unit
P_C	功耗 Power Dissipation	$t_a = 50^\circ\text{C}$ 150	mW
I_{Fmax}	峰值脉冲电流 Peak Pulse Current	$t_p = 10\mu\text{s}$ 120pps $T_a \leq 40^\circ\text{C}$	A
T_r T_J	贮存与工作结温范围 Storage and Operating Junction Temperature Range	40 to 125 40 to 110	$^\circ\text{C}$

DO-35 玻壳封装双向触发二极管特性曲线

DO-35 GLASS-SEALED BI-DIRECTIONAL TRIGGER DIODE

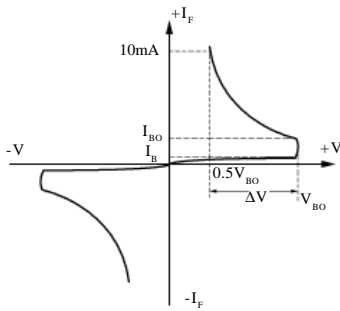

FIG-1 I - V 特性曲线
Current - voltage characteristics

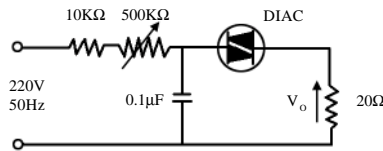

FIG-2 输出电压测试电路
Test circuit for output voltage

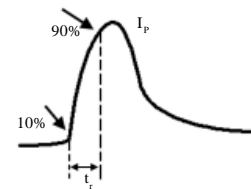

FIG-3 测试电路见图2, 调整R, $I_p=0.5A$
Test circuit see diagram 2. Adjust R for $I=0.5A$

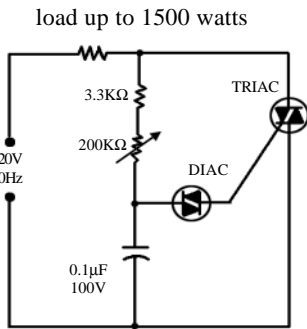

FIG-4 典型 DIAC-TRIAC 全波相控电路
Typical DIAC-TRIAC full-wave Phase control

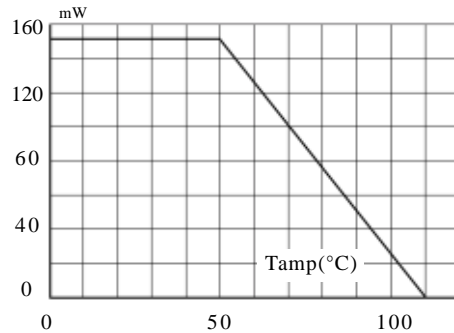

FIG-5 功耗环境温度关系曲线 (最大值)
Power dissipation versus ambient temperature(maximum values)

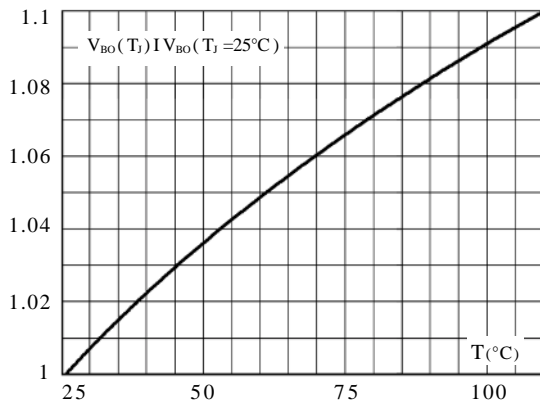

FIG-6 V_{BO} 的相对变化与结温关系曲线 (典型值)
Relative variation of V_{BO} versus junction temperature (typical values)

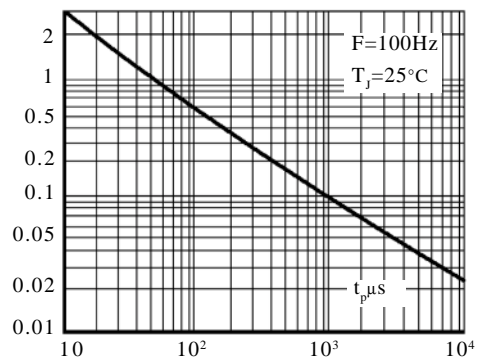

FIG-7 峰值脉冲电流与脉冲宽度关系曲线 (最大值)
Peak pulse Current versus pulse duration (maximum values)