

THINKING ELECTRONIC INDUSTRIAL CO., LTD.

HEAD OFFICE: 12F, No.93, Dashun 1st Rd., Zuoying Dist., Kaohsiung, Taiwan

TEL: 886-7-5577660 FAX: 886-7-5570560

MANUFACTURING SITE

- KAOHSIUNG FACTORY 1:No. 51, Kaifa Rd., N.E.P.Z, Kaohsiung City 81170, Taiwan
TEL: 886-7-9616668 FAX: 886-7-9616698
- KAOHSIUNG FACTORY 2:No. 2-2, Xinjian S. Rd., N.E.P.Z., Kaohsiung City 81170, Taiwan
TEL: 886-7-9630001 FAX: 886-7-3635113
- CHANGZHOU FACTORY: No.6 Longmen Rd., Wujin High & New-Tech Industrial
Development Zone, Changzhou, Jiangsu, China 213161
TEL:86-519-86578999 FAX:86-519-86558643
- DONG GUAN FACTORY: No.45, East Rd., Sha-Tao Dist., Chang-An Town,
Dongguan City, Guangdong, China 523863
TEL:86-769-85542016 FAX:86-769-85546890
- YICHANG FACTORY: No. 283 Xiaoting Avenue, Xiaoting Dist., Yichang
City 443007, Hubei, China
TEL:86-717-6510010 FAX:86-717-6511430

**SPECIFICATION FOR APPROVAL**

CUSTOMER	立創電子
CERTIFIED MODEL/TYPE	SMF22
PART NO.	SMF22CA (RoHS+HF)
APPLICATION	
CUSTOMER P/N	
ISSUE DATE	Mar.13,2021
REV. NO.	
REV. DATE	

FOR CUSTOMER APPROVAL	CHECKED BY
	<i>Yuan Feng</i>
	APPROVED BY
	<i>Huaifang Zhang</i>





REVISED RECORD SHEET

REV. NO	REV. DATE	REVISED CONTENT



INDEX	Page
■ Part Number Code	1
■ Structure and Dimensions	2
■ Electrical Characteristics	3 ~ 4
■ Reliability	5
■ Soldering Recommendation	6
■ Packaging	7
■ Pulse Waveform	8
■ Pulse Derating Curve	8
■ Peak Pulse Power Rating Curve	9
■ Steady State Power Derating Curve	10
■ Typical Junction Capacitance	11
■ RoHS Compliant Declaration	12
■ Warehouse Storage Conditions of Products	12
■ Safety Approvals & Certificates & Test Report	13



Part Number Code

Example :

SMF **22** **CA**
(1) (2) (3)

No.	Item	Digit	Specification
(1)	Product Type	SMF	Thinking Power TVS SMD Type
(2)	Reverse Stand off Voltage (V_{RWM})	22	22=22 V_{RWM}
(3)	Type Code	CA	Bi-directional 5% VBR Voltage Tolerance

Structure and Dimensions

Unit:inch(millimeter)

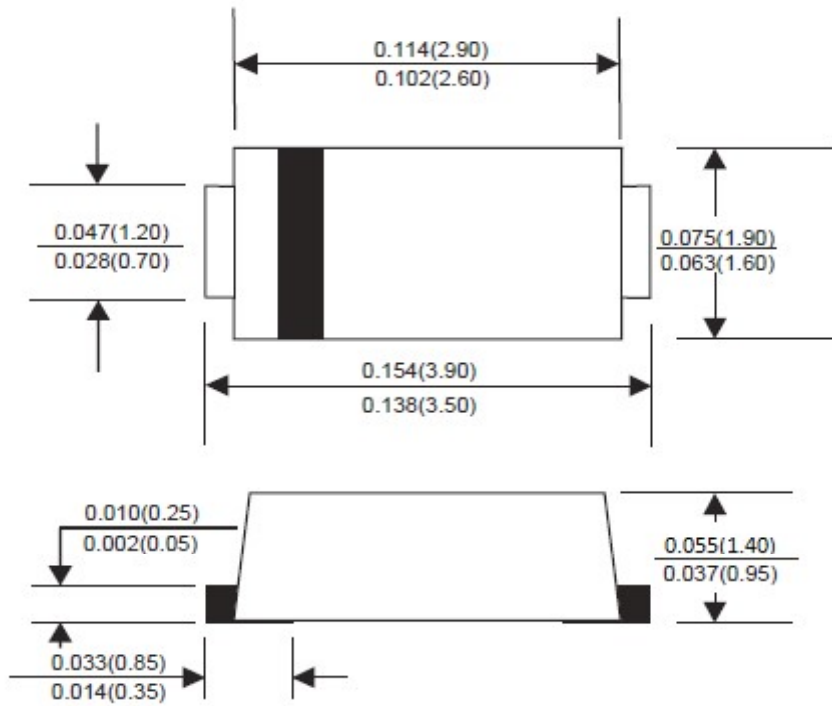

*The Cathode bend for Uni-directional product only.

Electrical Characteristics

Peak power dissipation with a 10/1000µs waveform : 200W

Operating junction and storage temperature range : -55~+150 °C

Part No. (Uni)	Part No. (Bi)	Reverse Stand off Voltage	Breakage Voltage VBR @ IT		Test Current	Maximum Clamping Voltage VC @ Ipp	Maximum Peak Pulse Current	Maximum Reverse Leakage IR @VRWM	Marking Code	
			VRWM (V)	Min(V)					Max(V)	IT(mA)
SMF5.0A	SMF5.0CA	5	6.4	7	10	9.2	21.7	400	FE.	KE.
SMF6.0A	SMF6.0CA	6	6.67	7.37	10	10.3	19.4	400	FG.	KG.
SMF6.5A	SMF6.5CA	6.5	7.22	7.98	10	11.2	17.9	250	FK.	KK.
SMF7.0A	SMF7.0CA	7	7.78	8.6	10	12	16.7	100	FM.	KM.
SMF7.5A	SMF7.5CA	7.5	8.33	9.21	1	12.9	15.5	50	FP.	KP.
SMF8.0A	SMF8.0CA	8	8.89	9.83	1	13.6	14.7	25	FR.	KR.
SMF8.5A	SMF8.5CA	8.5	9.44	10.4	1	14.4	13.9	10	FT.	KT.
SMF9.0A	SMF9.0CA	9	10	11.1	1	15.4	13	5	FV.	KV.
SMF10A	SMF10CA	10	11.1	12.3	1	17	11.8	2.5	FX.	KX.
SMF11A	SMF11CA	11	12.2	13.5	1	18.2	11	2.5	FZ.	KZ.
SMF12A	SMF12CA	12	13.3	14.7	1	19.9	10.1	2.5	HE.	LE.
SMF13A	SMF13CA	13	14.4	15.9	1	21.5	9.3	1	HG.	LG.
SMF14A	SMF14CA	14	15.6	17.2	1	23.2	8.6	1	HK.	LK.
SMF15A	SMF15CA	15	16.7	18.5	1	24.4	8.2	1	HM.	LM.
SMF16A	SMF16CA	16	17.8	19.7	1	26	7.7	1	HP.	LP.
SMF17A	SMF17CA	17	18.9	20.9	1	27.6	7.2	1	HR.	LR.
SMF18A	SMF18CA	18	20	22.1	1	29.2	6.8	1	HT.	LT.
SMF20A	SMF20CA	20	22.2	24.5	1	32.4	6.2	1	HV.	LV.
SMF22A	SMF22CA	22	24.4	26.9	1	35.5	5.6	1	HX.	LX.
SMF24A	SMF24CA	24	26.7	29.5	1	38.9	5.1	1	HZ.	LZ.
SMF26A	SMF26CA	26	28.9	31.9	1	42.1	4.8	1	JE.	ME.
SMF28A	SMF28CA	28	31.1	34.4	1	45.4	4.4	1	JG.	MG.
SMF30A	SMF30CA	30	33.3	36.8	1	48.4	4.1	1	JK.	MK.
SMF33A	SMF33CA	33	36.7	40.6	1	53.3	3.8	1	JM.	MM.
SMF36A	SMF36CA	36	40	44.2	1	58.1	3.4	1	JP.	MP.
SMF40A	SMF40CA	40	44.4	49.1	1	64.5	3.1	1	JR.	MR.
SMF43A	SMF43CA	43	47.8	52.8	1	69.4	2.9	1	JT.	MT.
SMF45A	SMF45CA	45	50	55.3	1	72.7	2.8	1	JV.	MV.
SMF48A	SMF48CA	48	53.3	58.9	1	77.4	2.6	1	JX.	MX.
SMF51A	SMF51CA	51	56.7	62.7	1	82.4	2.4	1	JZ.	MZ.
SMF54A	SMF54CA	54	60	66.3	1	87.1	2.3	1	XE.	NE.
SMF58A	SMF58CA	58	64.4	71.2	1	93.6	2.1	1	XG.	NG.
SMF60A	SMF60CA	60	66.7	73.7	1	96.8	1.8	1	XK.	NK.

Electrical CharacteristicsPeak power dissipation with a 10/1000 μ s waveform : 200W

Operating junction and storage temperature range : -55~+150 °C

Part No. (Uni)	Part No. (Bi)	Reverse Stand off Voltage	Breakage Voltage VBR @ IT		Test Current	Maximum Clamping Voltage VC @ Ipp	Maximum Peak Pulse Current	Maximum Reverse Leakage IR @VRWM	Marking Code	
			VRWM (V)	Min(V)					Max(V)	IT(mA)
SMF64A	SMF64CA	64	71.1	78.6	1	103	1.7	1	XM.	NM.
SMF70A	SMF70CA	70	77.8	86	1	113	1.5	1	XP.	NP.
SMF75A	SMF75CA	75	83.3	92.1	1	121	1.4	1	XR.	NR.
SMF78A	SMF78CA	78	86.7	95.8	1	126	1.4	1	XT.	NT.
SMF85A	SMF85CA	85	94.4	104	1	137	1.3	1	XV.	NV.
SMF90A	SMF90CA	90	100	111	1	146	1.2	1	XX.	NX.
SMF100A	SMF100CA	100	111	123	1	162	1.1	1	XZ.	NZ.
SMF110A	SMF110CA	110	122	135	1	177	1	1	TE.	PE.
SMF120A	SMF120CA	120	133	147	1	193	0.9	1	TG.	PG.
SMF130A	SMF130CA	130	144	159	1	209	0.8	1	TK.	PK.
SMF150A	SMF150CA	150	167	185	1	243	0.7	1	TM.	PM.
SMF160A	SMF160CA	160	178	197	1	259	0.7	1	TP.	PP.
SMF170A	SMF170CA	170	189	209	1	275	0.6	1	TR.	PR.

Reliability

Item	Standard	Test conditions / Methods	Specifications
HTRB (High Temp. Reverse Bias Test)	MIL-STD-750D METHOD 1038.3 Method 103	Test Temp. : 150°C Duration 168 hrs with rated VRWM	Electrical properties meet Specifications
PCT (Pressure Cooker Test)	MIL-STD-19500 EAPPENDIX C	Test Temp. : 121 °C Pressure:1.2Kg Duration: 96 hrs	Electrical properties meet Specifications
TCT	MIL-STD-750D METHOD 1051.5	Test Temp. : -55°C ~+150°C 20 cycles	Electrical properties meet Specifications
Forward Surge	MIL-STD-750D METHOD 4066.3	Sine half wave 8.3mS 1 shot IFSM:20A forSMF 40A for SMA 100A for SMB 200A for SMC For Uni-directional product only.	Electrical properties meet Specifications
Soldering Heat	MIL-STD-750D METHOD 2031.2	Test Temp. : 260°C Duration:10 sec 1cycle	Electrical properties meet Specifications

Soldering Recommendation

IR-reflow soldering profile



Reflow Condition	Lead-free assembly
Preheat -Temperature Min(Ts min) -Temperature Min(Ts max) -Time (min to max) (ts)	150°C 200°C 60 – 180 seconds
Average ramp up rate -Temperature Liquidus (TL) to peak	3°C/second max
Ts(max) to TL -Ramp-up Rate	3°C/second max.
Reflow -Temperature Liquidus (TL) -Time (tL)	217°C 60 – 150 seconds
Peak Temperature (TP)	260°C
Time within 5°C of actual peak Temperature(tp)	20 – 40 seconds
Ramp-down Rate	6°C/second max.
Time 25°C to peak Temperature(TP)	8 minutes max.
Do not exceed	260°C

Packaging

■ Taping Specification

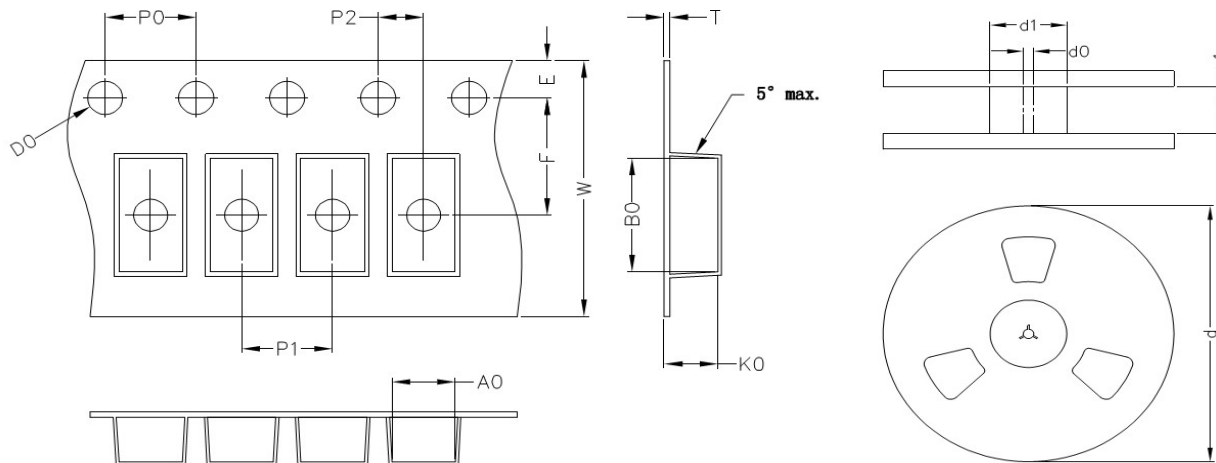

(Unit : mm)

Index	A0	B0	K0	D0	E	F	P0	P1	P2	T	W	d (7")	d1	d0	w1
SMF	2	3.95	1.45	1.55	1.75	3.5	4	4	2	0.23	8	178	60	13	9.5

Notes : 1.The tolerance of carrier tape and top cover is ± 0.1 mm,the tolerance of reel is ± 2 mm

Notes : 2.For the SMF series, different reel materials will produce differently structured reels

■ Quantity

Series Type	Reel size	Quantity (pcs/reel)
SMF	7"	3,000

Pulse Waveform

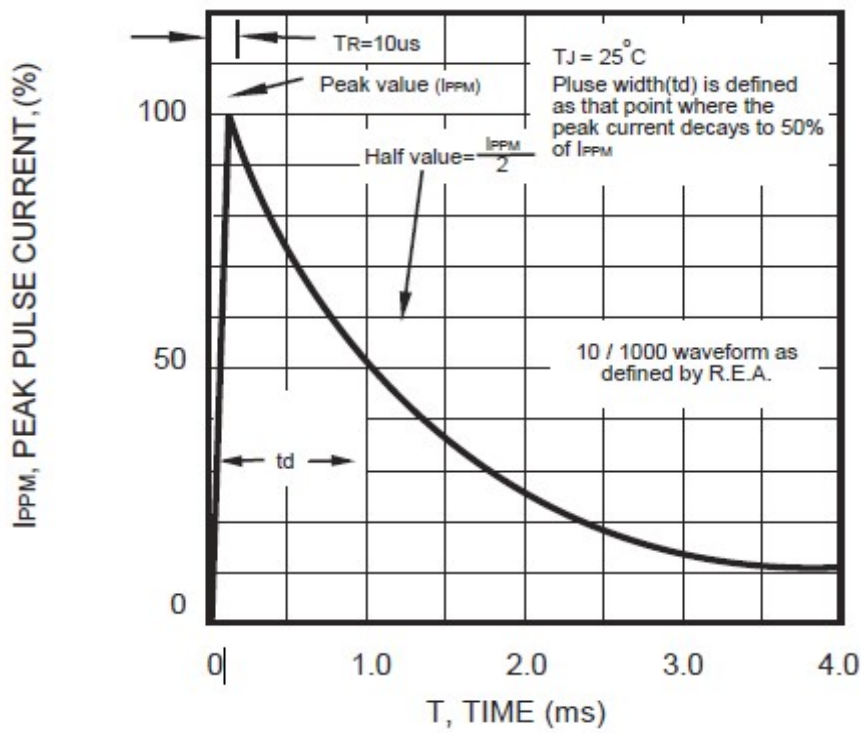

Pulse Derating Curve

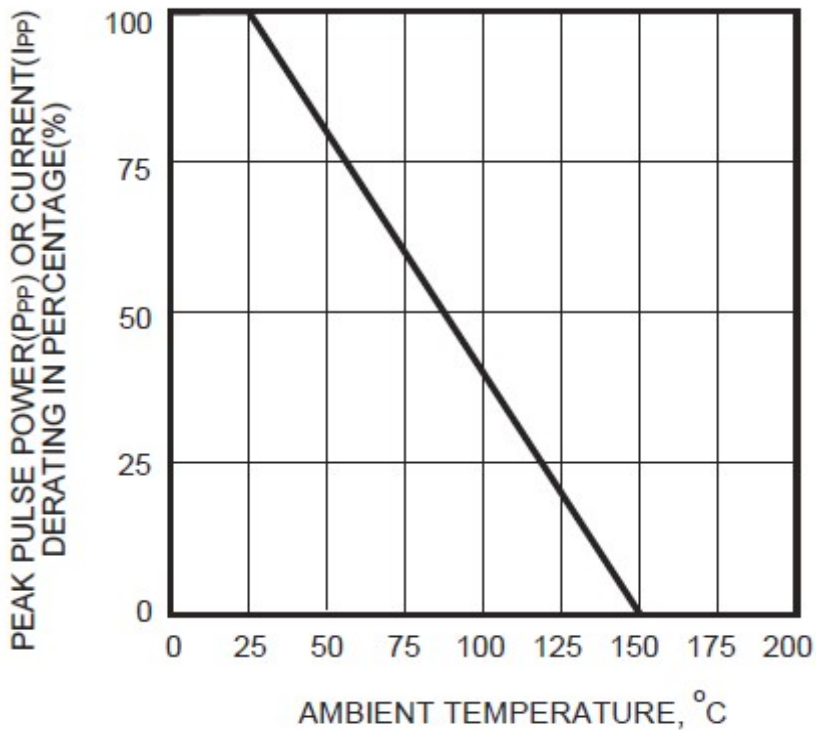

Peak Pulse Power Rating Curve

SMF series

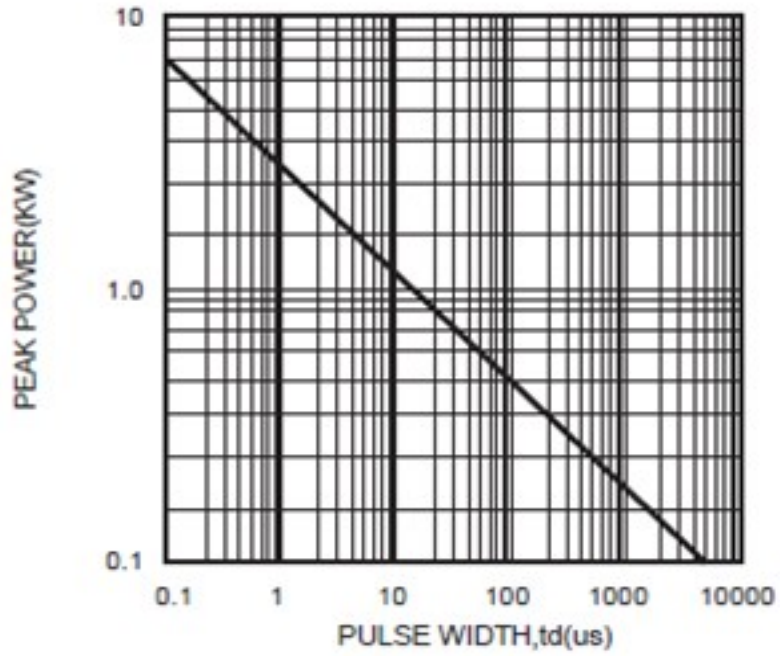

Steady State Power Derating Curve

SMF series

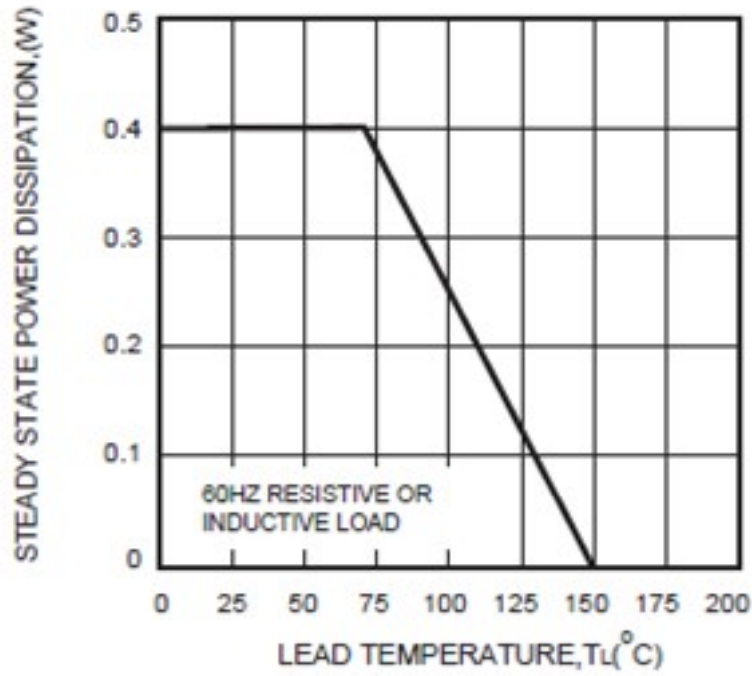

Typical Junction Capacitance

SMF series

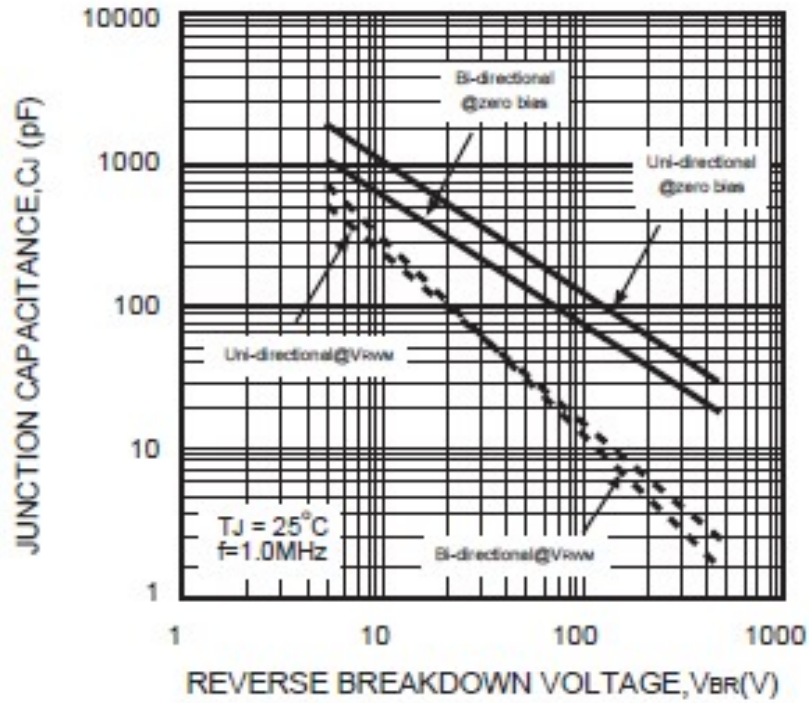

RoHS Compliant Declaration

We hereby declare that the components delivered to your company are compliant with RoHS directive 2015/863/EU.

Warehouse Storage Conditions of Products

(I) Storage Conditions :

- 1.Storage Temperature : $-10^{\circ}\text{C} \sim +40^{\circ}\text{C}$
- 2.Relative Humidity : $\leq 75\% \text{RH}$
- 3.Keep away from corrosive atmosphere and sunlight.

(II) Period of Storage : 1 year

Safety Approvals



* UL 497B recognized (File # E229991)

Certificates

- (1) IATF 16949 certificate
- (2) ISO 9001 certificate

Test Report

- (1) RoHS test report
- (2) Halogen-free test report