



Features

- Ideal for indication light on hand held products
- Long life and robust package
- Standard Package: 500pcs/ Reel
- MSL (Moisture Sensitivity Level): 3
- Halogen-free
- RoHS compliant

Applications

- Backlighting for tell-tale indicators
- Dashboard lighting
- Interior lighting (footwell, dome light, accent lighting, etc.)
- Exterior lighting (turn signals, side markers, CHMSL, etc.)
- Signs and signals
- Various applications requiring high temperature rating



ATTENTION
OBSERVE PRECAUTIONS
FOR HANDLING
ELECTROSTATIC
DISCHARGE
SENSITIVE
DEVICES

Package Schematics

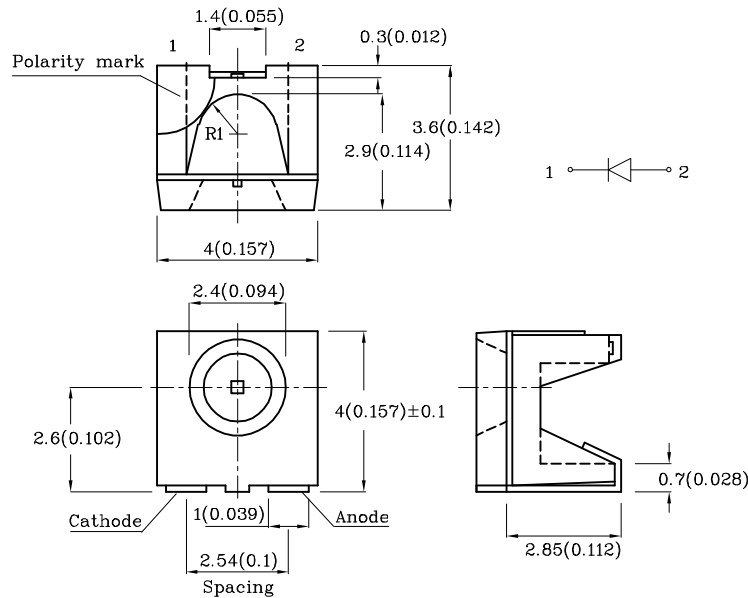

Notes:

1. All dimensions are in millimeters (inches).
2. Tolerance is $\pm 0.25(0.01)$ unless otherwise noted.
3. Specifications are subject to change without notice.

Handling Precautions

Compare to epoxy encapsulant that is hard and brittle, silicone is softer and flexible. Although its characteristic significantly reduces thermal stress, it is more susceptible to damage by external mechanical force.

As a result, special handling precautions need to be observed during assembly using silicone encapsulated LED products. Failure to comply might lead to damage and premature failure of the LED.

1. Handle the component along the side surfaces by using forceps or appropriate tools.

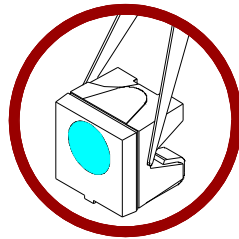

2. Do not directly touch or handle the silicone lens surface. It may damage the internal circuitry.

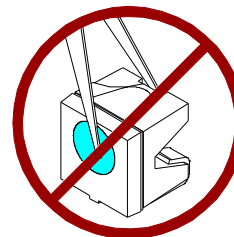
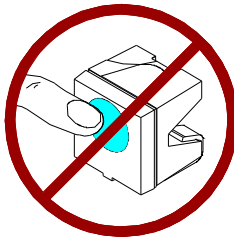

3. As silicone encapsulation is permeable to gases, some corrosive substances such as H₂S might corrode silver plating of leadframe. Special care should be taken if an LED with silicone encapsulation is to be used near such substances.

Part Number	Emitting Color	Emitting Material	Lens-color	Luminous Intensity CIE127-2007* (If=30mA) mcd			Viewing Angle [1]
				Code.	Min.	Max.	
XZM2CYK67S30MAV-HTA	Yellow	AlGaInP	Water Clear	R*	400*	500*	120°
				S*	500*	700*	
				T*	700*	1000*	

Note:

1.01/2 is the angle from optical centerline where the luminous intensity is 1/2 of the optical peak value.

*Luminous intensity value is in accordance with CIE127-2007 standards.

Absolute Maximum Ratings at Ta=25°C

Parameter	Symbol	Value	Unit
Power dissipation	PD	125	mW
Junction temperature	TJ	115	°C
Reverse Voltage	VR	5	V
Operating Temperature	Top	-40 To +100	°C
Storage Temperature	Tstg	-40 To +115	°C
DC Forward Current	IF	50	mA
Peak Forward Current [2]	IFM	140	mA
Electrostatic Discharge Threshold (HBM)		3000	V
Thermal Resistance (Junction/ambient) [1]	Rth j-a	360	°C/W
Thermal Resistance (Junction / Solder point) [1]	Rth j-s	200	°C/W

Notes:

1. Rth(j-a) Results from mounting on PC board FR4 (pad size≥16 mm² per pad),

2. 1/10 Duty Cycle, 0.1ms Pulse Width.

3. A Relative Humidity between 40% and 60% is recommended in ESD-protected work areas to reduce static build up during assembly process (Reference JEDEC/JESD625-A and JEDEC/J-STD-033)

Electrical / Optical Characteristics at Ta=25°C

Parameter	Symbol	Value				Unit
		Code.	Min.	Typ.	Max.	
Wavelength at peak emission CIE127-2007* If = 30mA	λpeak	-	-	590*	-	nm
Dominant Wavelength CIE127-2007* If = 30mA	λdom	3*	586*	-	588*	nm
		4*	588*	-	590*	
		5*	590*	-	592*	
		6*	592*	-	594*	
Spectral bandwidth at 50% FREL MAX If = 30mA	Δλ	-	-	20		nm
Forward Voltage If = 30mA	VF	-	-	2.1	2.5	V
Reverse Current (VR = 5V)	IR	-	-	-	10	μA
Temperature coefficient of λpeak If = 30mA, -10°C ≤ T ≤ 100°C	TCλpeak	-	-	0.12	-	nm/°C
Temperature coefficient of λdom If = 30mA, -10°C ≤ T ≤ 100°C	TCλdom	-	-	0.07	-	nm/°C
Temperature coefficient of VF If = 30mA, -10°C ≤ T ≤ 100°C	TCv	-	-	-2.0	-	mV/°C

Notes:

1. Wavelength : + / -1nm.

2. Forward Voltage: +/-0.1V.

* Wavelength value is in accordance with CIE127-2007 standards.

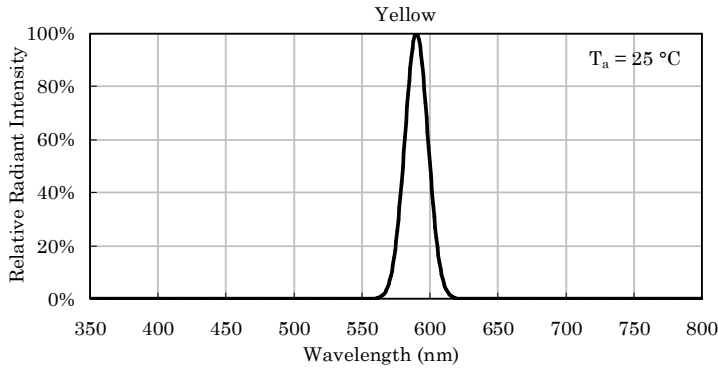

Relative Intensity Vs. CIE Wavelength

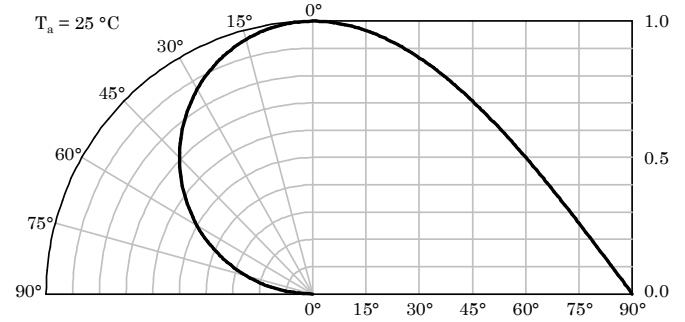

Spatial Distribution

❖ Yellow

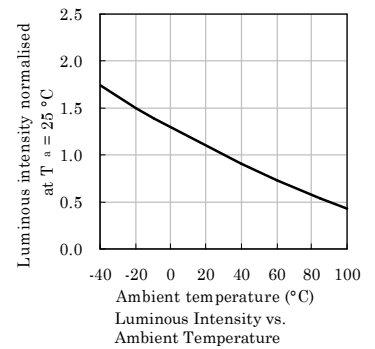
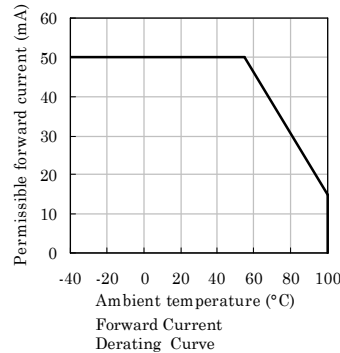
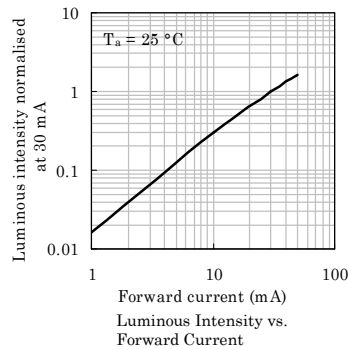
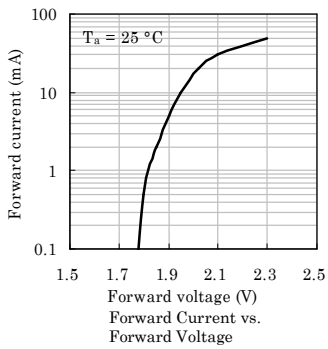

LED is recommended for reflow soldering and soldering profile is shown below.

Reflow Soldering Profile for SMD Products (Pb-Free Components)

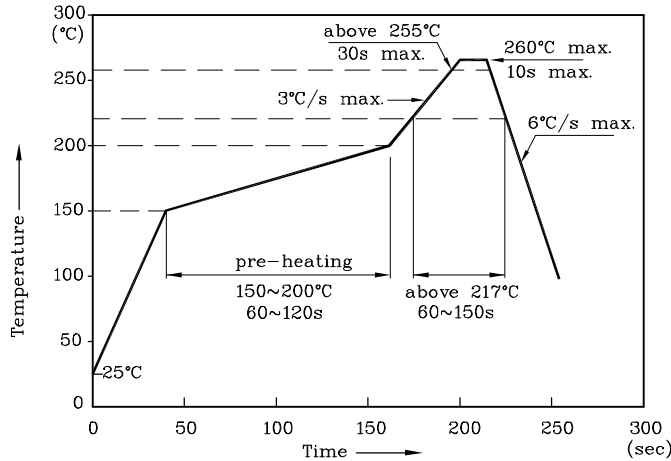

Notes:

1. All temperatures refer to the center of the package, measured on the package body surface facing up during reflow.
2. Do not apply any stress to the LED during high temperature conditions.
3. Maximum number of soldering passes: 2

❖ The device has a single mounting surface.
The device must be mounted according to the specifications.

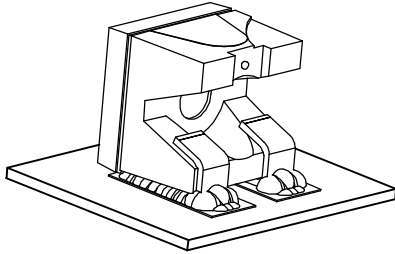

❖ Reel Dimension

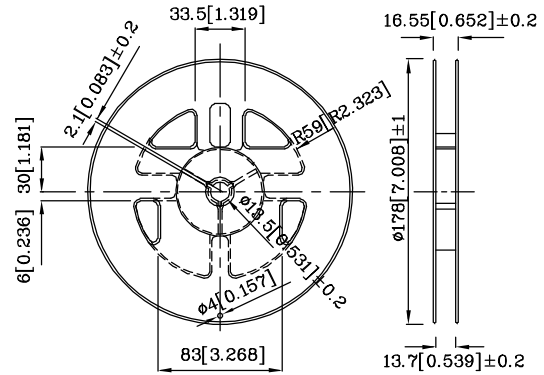

❖ Recommended Soldering Pattern
(Units : mm; Tolerance: ± 0.1)

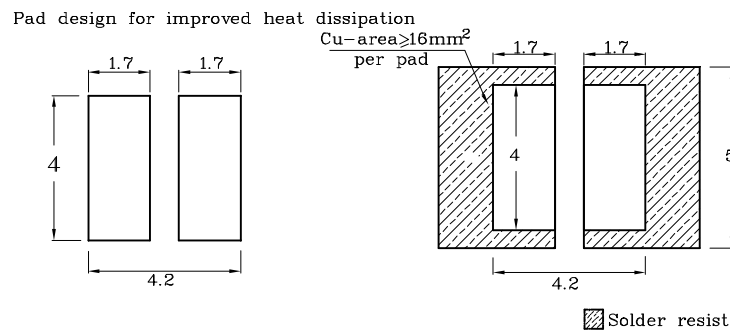

❖ Tape Specification (Units : mm)

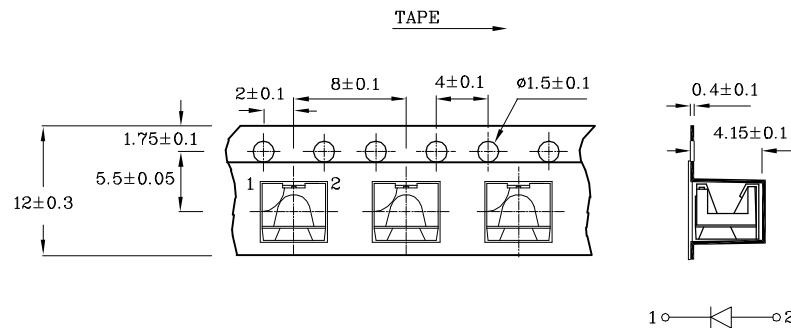

Remarks:

If special sorting is required (e.g. binning based on forward voltage, Luminous intensity / luminous flux, or wavelength), the typical accuracy of the sorting process is as follows:

1. Wavelength: +/-1nm
2. Luminous intensity / luminous flux: +/-15%
3. Forward Voltage: +/-0.1V

Note: Accuracy may depend on the sorting parameters.



PACKING & LABEL SPECIFICATIONS

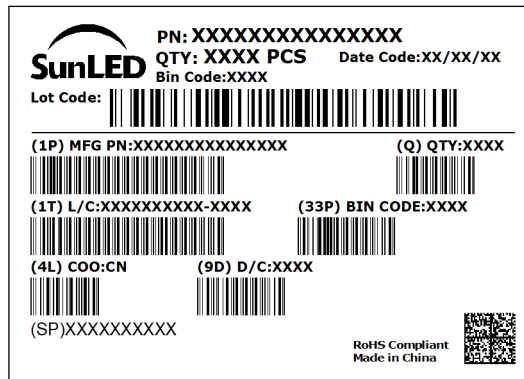
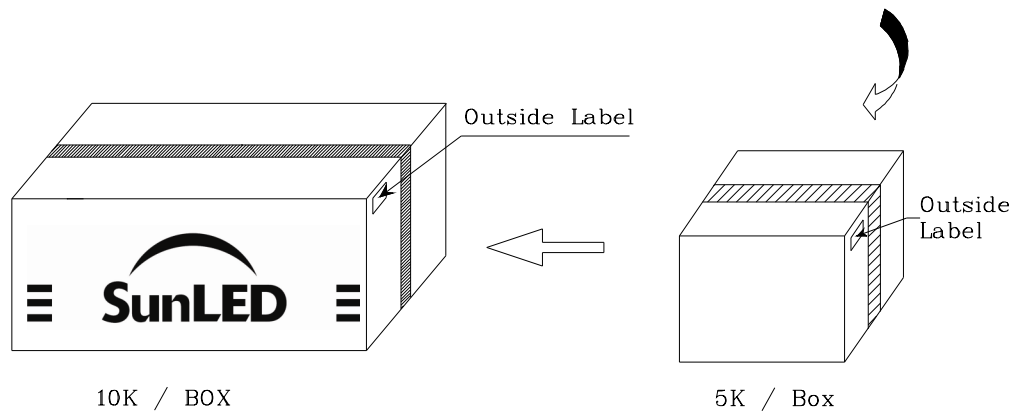
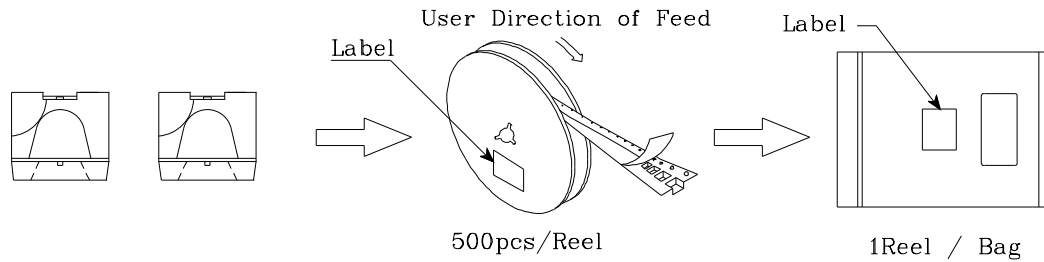

TERMS OF USE

1. Data presented in this document reflect statistical figures and should be treated as technical reference only.
2. Contents within this document are subject to improvement and enhancement changes without notice.
3. The product(s) in this document are designed to be operated within the electrical and environmental specifications indicated on the datasheet. User accepts full risk and responsibility when operating the product(s) beyond their intended specifications.
4. The product(s) described in this document are intended for electronic applications in which a person's life is not reliant upon the LED. Please consult with a SunLED representative for special applications where the LED may have a direct impact on a person's life.
5. The contents within this document may not be altered without prior consent by SunLED.
6. Additional technical notes are available at <https://www.SunLEDusa.com/TechnicalNotes.asp>

Reliability Test Items And Conditions

The reliability of products shall be satisfied with items listed below

Lot Tolerance Percent Defective (LTPD) : 10%

No.	Test Item	Standards	Test Condition	Test Times / Cycles	Number of Damaged
1	Continuous operating test	-	T _a = 25°C, I _F = maximum rated current *	1,000 h	0 / 22
2	High Temp. operating test	EIAJ ED-4701/100(101)	T _a = 100°C, I _F = maximum rated current *	1,000 h	0 / 22
3	Low Temp. operating test	-	T _a = -40°C, I _F = maximum rated current *	1,000 h	0 / 22
4	High temp. storage test	EIAJ ED-4701/100(201)	T _a = maximum rated storage temperature	1,000 h	0 / 22
5	Low temp. storage test	EIAJ ED-4701/100(202)	T _a = -40°C	1,000 h	0 / 22
6	High temp. & humidity storage test	EIAJ ED-4701/100(103)	T _a = 60°C, RH = 90%	500 h	0 / 22
7	High temp. & humidity operating test	EIAJ ED-4701/100(102)	T _a = 60°C, RH = 90% I _F = maximum rated current *	500 h	0 / 22
8	Soldering reliability test	EIAJ ED-4701/100(301)	Moisture soak: 30°C, 70% RH, 72h Preheat: 150~180°C (120s max.) Soldering temp: 260°C(10s)	2 times	0 / 18
9	Thermal shock operating test	-	T _a = -40°C(15min) ~ 100°C(15min) I _F = derated current at 100°C	1,000 cycles	0 / 22
10	Thermal shock test	-	T _a = -40°C(15min) ~ maximum rated Storage temperature(15min)	1,000 cycles	0 / 22
11	Electric Static Discharge (ESD)	EIAJ ED-4701/100(304)	C = 100pF, R2 = 1.5KΩ V = 3000V	Once each Polarity	0 / 22
12	Vibration test	-	a = 196m/s ² , f = 100~2KHz, t = 48min for all xyz axes	4 times	0 / 22

* : Refer to forward current vs. derating curve diagram

Criteria for Judging Damage

Items	Symbols	Conditions	Failure Criteria
luminous Intensity	I _v	I _F = 30mA	Testing Min. Value < Spec.Min.Value x 0.5
Forward Voltage	V _F	I _F = 30mA	Testing Max. Value ≥ Spec.Max.Value x 1.2
Reverse Current	I _R	V _R = Maximum Rated Reverse Voltage	Testing Max. Value ≥ Spec.Max.Value x 2.5
High temp. storage test	-	-	Occurrence of notable decoloration, deformation and cracking