

AN2050FB

CCD Monochrome Video Camera Signal Processor IC

Overview

The AN2050FB is an integrated circuit specified to the monochrome CCD image element which is employed in the monitoring video cameras, door phones, TV telephone sets, etc. The high frequency block and power block that are composed of 3-chip of DS signal processing, AGC, Γ compensating and NTSC output so far, are integrated into one chip to offer low cost.

Features

- Frequency characteristics:10MHz (icompatible with the CCD image element of 330,000 pixels)
- AGC range:18dB (improved SN ratio)
- Operating supply voltage range:4.5V to 5.3V (typ. 5V)
- Power consumption:typ. 225mW

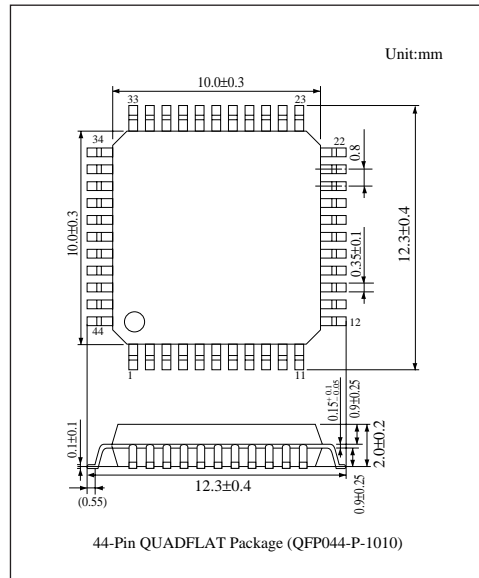

Block Diagram

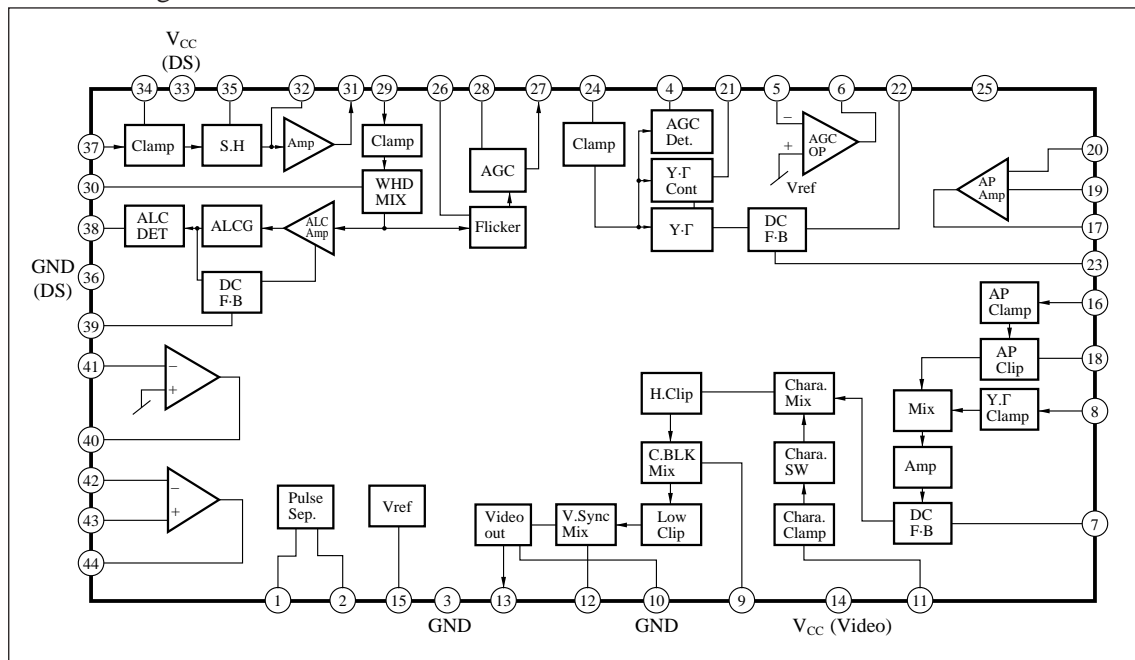

■ Absolute Maximum Ratings (Ta=25°C)

Parameter	Symbol	Rating	Unit
Supply voltage	V _{CC}	5.5	V
Supply current	I _{CC}	54	mA
Power dissipation	P _D	280	mW
Operating ambient temperature	T _{opr}	-20 to +75	°C
Storage temperature	T _{stg}	-55 to +125	°C

■ Recommended Operating Range (Ta=25°C)

Parameter	Symbol	Range
Operating supply voltage range	V _{CC}	4.5V to 5.3V







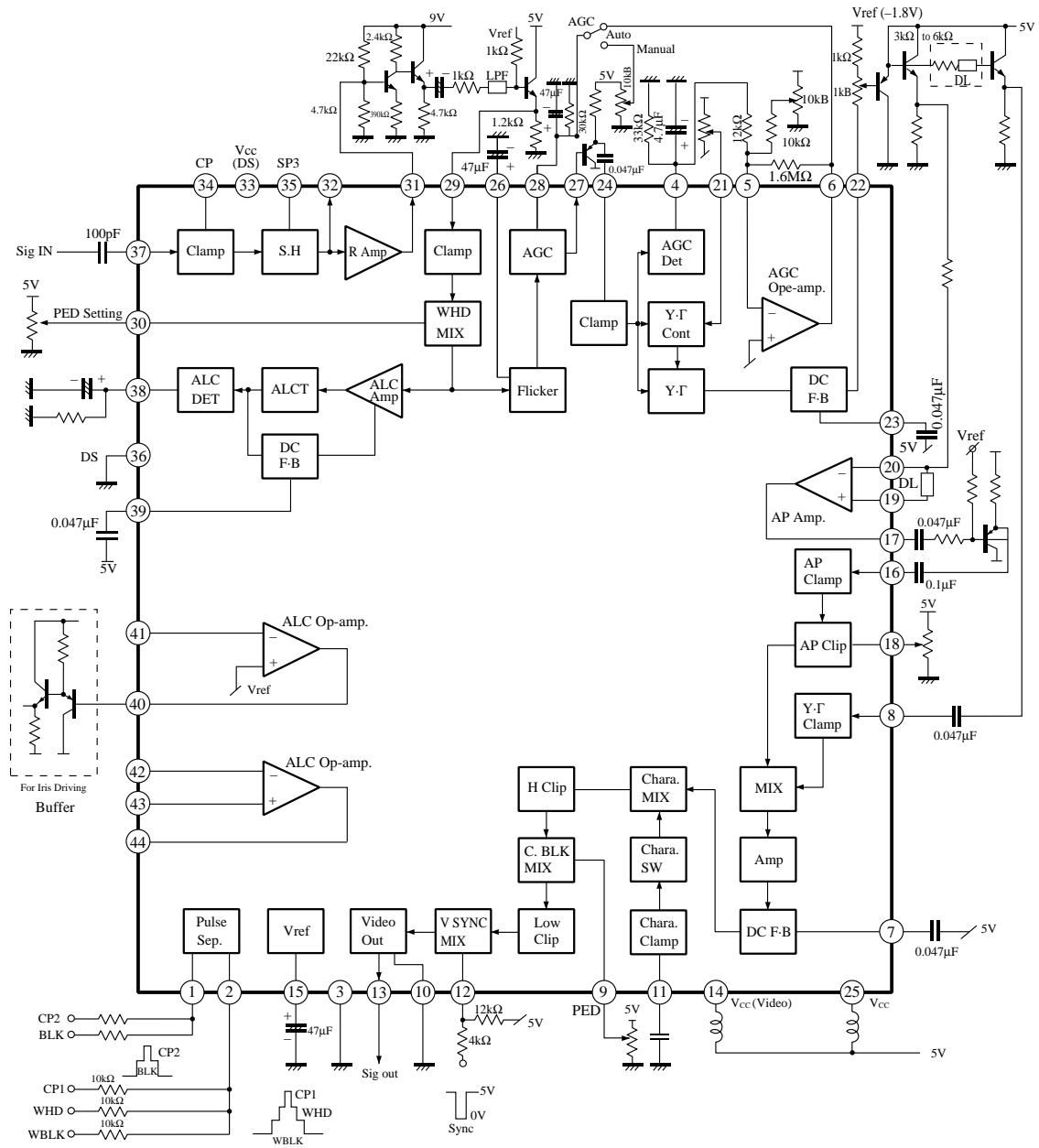



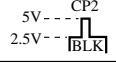
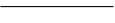
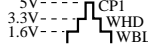
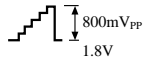
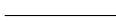
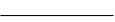

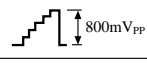

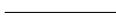
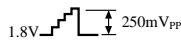
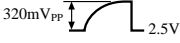
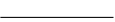

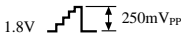

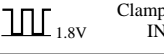

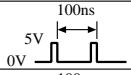

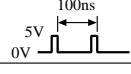

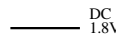
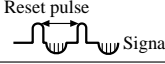
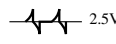
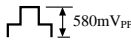
■ Electrical Characteristics (Ta=25°C)

Parameter	Symbol	Condition	min	typ	max	Unit
OB control (1)	V _{OB1}	V _{CC} =5V	35	55	75	mV _{PP}
OB control (2)	V _{OB2}	V _{CC} =5V	-85	-65	-45	mV _{PP}
AGC amp gain (1)	G _{AGC1}	V _{CC} =5V	130	170	210	mV _{PP}
AGC amp gain (2)	G _{AGC2}	V _{CC} =5V	16	19	22	dB
ALC DET output	V _{ALC}	V _{CC} =5V	500	600	700	mV _{PP}
Γ circuit gain (1)	G _{Γ1}	V _{CC} =5V	660	800	940	mV _{PP}
Γ circuit gain (2)	G _{Γ2}	V _{CC} =5V	—	—	550	mV _{PP}
AGC DET output	V _{AGC/DET}	V _{CC} =5V	400	480	560	mV _{PP}
AP clip (1)	G _{CL1}	V _{CC} =5V	0.9	1.1	1.4	V _{PP}
AP clip (2)	G _{CL2}	V _{CC} =5V	—	—	-10	dB
YΓ amp gain	G _{YΓ}	V _{CC} =5V	1.1	1.3	1.5	V _{PP}
Supply current (1)	I ₂₅	V _{CC} =5V	26.5	31	35.5	mA
Supply current (2)	I ₃₃	V _{CC} =5V	9.5	14	18.5	mA
CP1 pulse separation level	V _{CP1}	V _{CC} =5V	3.4	3.8	4.2	V
WHD pulse separation level	V _{WHD}	V _{CC} =5V	2.15	2.55	2.95	V
WBL pulse separation level	V _{WBL}	V _{CC} =5V	0.4	0.8	1.2	V
CP2 pulse separation level	V _{CP2}	V _{CC} =5V	3.1	3.5	3.9	V
BLK pulse separation level	V _{BLK}	V _{CC} =5V	0.6	1	1.4	V

Application Circuit

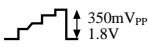

■ Pin Descriptions

Pin No.	Pin name	Typ. waveform	Pin No.	Pin name	Typ. waveform
1	Pulse input 1		23	DC control	
2	Pulse input 2		24	γ input	
3	GND		25	V_{CC}	
4	AGC DET		26	Flicker control	Open 1.8V
5	AGC op. amp. input -		27	AGC output	
6	AGC op. amp. output		28	AGC control	
7	DC control		29	AGC input	
8	$Y\gamma$ input		30	PED setting	
9	PED		31	DS amp. output	
10	GND		32	DC output	
11	Character input		33	V_{CC} (DS)	
12	SYNC input		34	Clamp pulse input	
13	Video output		35	Sample hold pulse input	
14	V_{CC} (Video)		36	GND (DS)	
15	V_{ref}		37	DS input	
16	Aperture input		38	ALC DET	
17	Aperture amp. output		39	DC control	
18	Aperture clip		40	ALC op. amp. output	
19	Aperture amp. input +		41	ALC op. amp. input -	
20	Aperture amp. input -		42	ALC op. amp. input -	
21	γ control		43	ALC op. amp. input +	
22	γ output		44	ALC op. amp. output	