

WNM3003

N-Channel, 30V, 4.0A, Power MOSFET

[Http://www.willsemi.com](http://www.willsemi.com)

$V_{(BR)DSS}$	$R_{ds(on)}$ (Ω)
30V	0.033@ 10V
	0.033@ 10V
	0.043 @ 4.5V

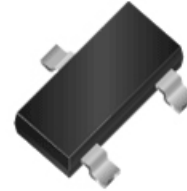

SOT-23

Descriptions

The WNM3003 is N-Channel enhancement MOS Field Effect Transistor. Uses advanced trench technology and design to provide excellent $R_{DS(ON)}$ with low gate charge. This device is suitable for use in DC-DC conversion and power switch applications. Standard Product WNM3003 is Pb-free.

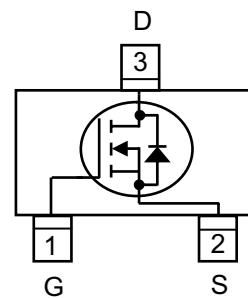

Configuration (Top View)

Features

- Trench Technology
- Supper high density cell design
- Excellent ON resistance for higher DC current
- Extremely Low Threshold Voltage
- Small package SOT-23

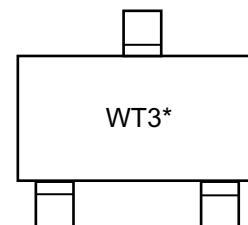

WT3 = Device Code
* = Month (A~Z)

Marking

Applications

- Driver for Relay, Solenoid, Motor, LED etc.
- DC-DC converter circuit
- Power Switch
- Load Switch
- Charging

Order Information

Device	Package	Shipping
WNM3003-3/TR	SOT-23	3000/Tape&Reel

Absolute Maximum ratings

Parameter		Symbol	10 S	Steady State	Unit
Drain-Source Voltage		V_{DS}	30		V
Gate-Source Voltage		V_{GS}	± 20		
Continuous Drain Current ^a	$T_A=25^\circ\text{C}$	I_D	4.0	3.7	A
	$T_A=70^\circ\text{C}$		3.2	3.0	
Maximum Power Dissipation ^a	$T_A=25^\circ\text{C}$	P_D	0.8	0.7	W
	$T_A=70^\circ\text{C}$		0.5	0.4	
Continuous Drain Current ^b	$T_A=25^\circ\text{C}$	I_D	3.7	3.4	A
	$T_A=70^\circ\text{C}$		2.9	2.7	
Maximum Power Dissipation ^b	$T_A=25^\circ\text{C}$	P_D	0.7	0.6	W
	$T_A=70^\circ\text{C}$		0.4	0.3	
Pulsed Drain Current ^c		I_{DM}	10		A
Operating Junction Temperature		T_J	150		$^\circ\text{C}$
Lead Temperature		T_L	260		$^\circ\text{C}$
Storage Temperature Range		T_{stg}	-55 to 150		$^\circ\text{C}$

Thermal resistance ratings

Parameter		Symbol	Typical	Maximum	Unit
Junction-to-Ambient Thermal Resistance ^a	$t \leq 10 \text{ s}$	$R_{\theta JA}$	120	145	$^\circ\text{C/W}$
	Steady State		132	168	
Junction-to-Ambient Thermal Resistance ^b	$t \leq 10 \text{ s}$	$R_{\theta JA}$	145	174	
	Steady State		158	202	
Junction-to-Case Thermal Resistance		$R_{\theta JC}$	60	75	

a Surface mounted on FR4 Board using 1 square inch pad size, 1oz copper

b Surface mounted on FR4 board using minimum pad size, 1oz copper

c Repetitive rating, pulse width limited by junction temperature, $t_p=10\mu\text{s}$, Duty Cycle=1%

d Repetitive rating, pulse width limited by junction temperature $T_J=150^\circ\text{C}$.

Electronics Characteristics (Ta=25°C, unless otherwise noted)

Parameter	Symbol	Test Conditions	Min	Typ	Max	Unit
OFF CHARACTERISTICS						
Drain-to-Source Breakdown Voltage	BV_{DSS}	$V_{GS} = 0\text{ V}, I_D = 250\mu\text{A}$	30			V
Zero Gate Voltage Drain Current	I_{DSS}	$V_{DS} = 24\text{ V}, V_{GS} = 0\text{ V}$			1	μA
Gate-to-source Leakage Current	I_{GSS}	$V_{DS} = 0\text{ V}, V_{GS} = \pm 20\text{ V}$			± 100	nA
ON CHARACTERISTICS						
Gate Threshold Voltage	$V_{GS(TH)}$	$V_{GS} = V_{DS}, I_D = 250\mu\text{A}$	1.0	1.6	3.0	V
Drain-to-source On-resistance	$R_{DS(on)}$	$V_{GS} = 10\text{ V}, I_D = 3.1\text{ A}$		33	47	m Ω
		$V_{GS} = 10\text{ V}, I_D = 2.5\text{ A}$		33	47	
		$V_{GS} = 4.5\text{ V}, I_D = 2.0\text{ A}$		43	59	
Forward Transconductance	g_{FS}	$V_{DS} = 4.5\text{ V}, I_D = 2.8\text{ A}$		5.8		S
CHARGES, CAPACITANCES AND GATE RESISTANCE						
Input Capacitance	C_{ISS}	$V_{GS} = 0\text{ V}, f = 1.0\text{ MHz}, V_{DS} = 15\text{ V}$		570		pF
Output Capacitance	C_{OSS}			72		
Reverse Transfer Capacitance	C_{RSS}			64		
Total Gate Charge	$Q_{G(TOT)}$	$V_{GS} = 10\text{ V}, V_{DS} = 15\text{ V}, I_D = 3.1\text{ A}$		11.6		nC
Threshold Gate Charge	$Q_{G(TH)}$			0.8		
Gate-to-Source Charge	Q_{GS}			1.25		
Gate-to-Drain Charge	Q_{GD}			3.0		
SWITCHING CHARACTERISTICS						
Turn-On Delay Time	$t_d(ON)$	$V_{GS} = 10\text{ V}, V_{DS} = 15\text{ V}, I_D = 1\text{ A}, R_G = 6\ \Omega$		5		ns
Rise Time	t_r			3.3		
Turn-Off Delay Time	$t_d(OFF)$			39		
Fall Time	t_f			4.4		
BODY DIODE CHARACTERISTICS						
Forward Voltage	V_{SD}	$V_{GS} = 0\text{ V}, I_S = 1.5\text{ A}$	0.50	0.84	1.50	V

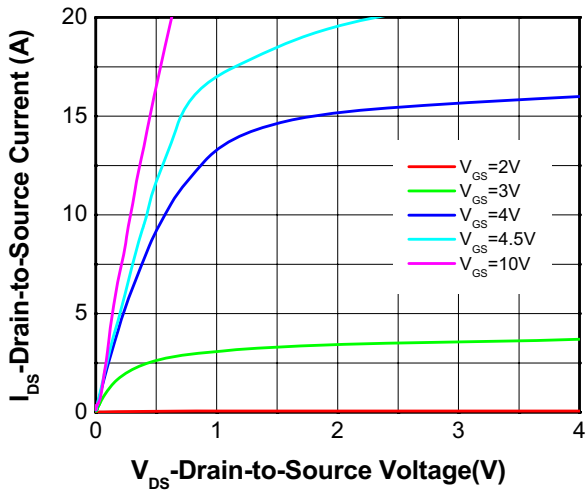
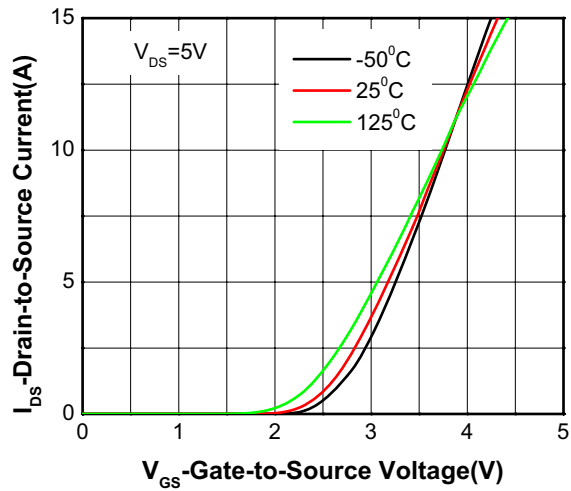
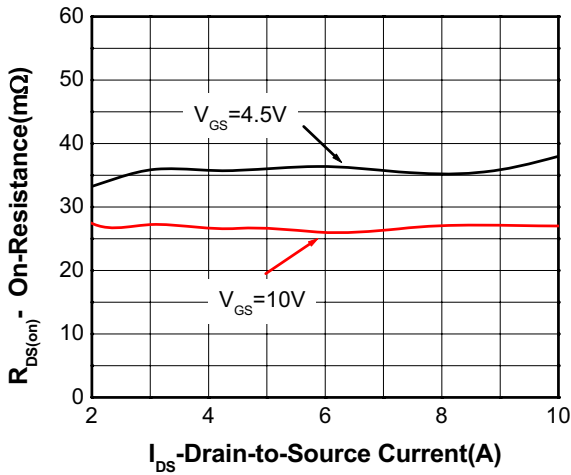
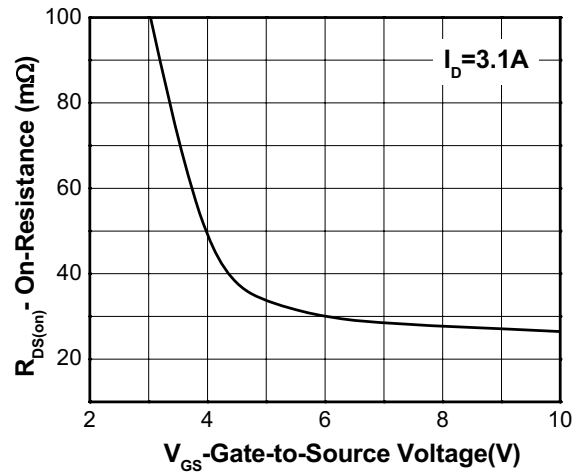
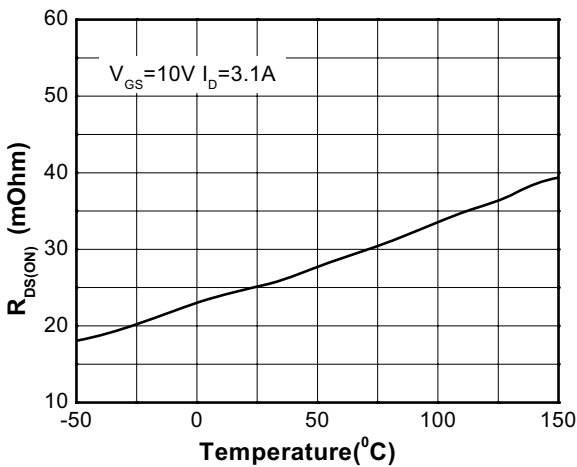
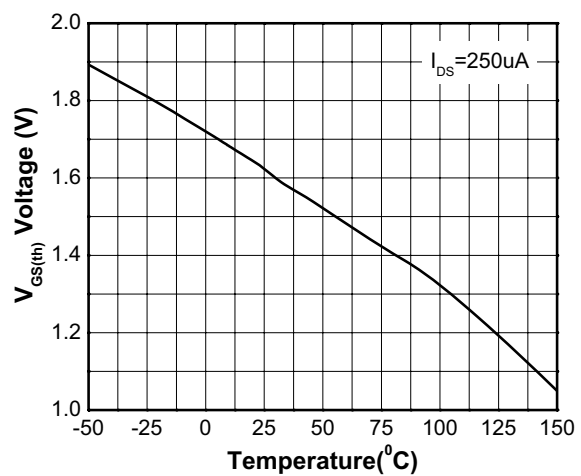
Typical Characteristics (Ta=25°C, unless otherwise noted)

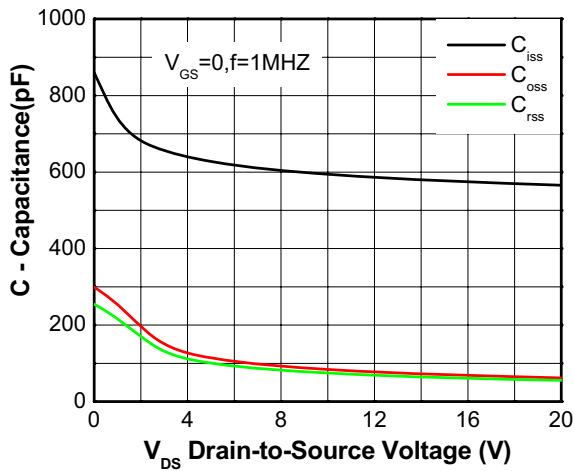
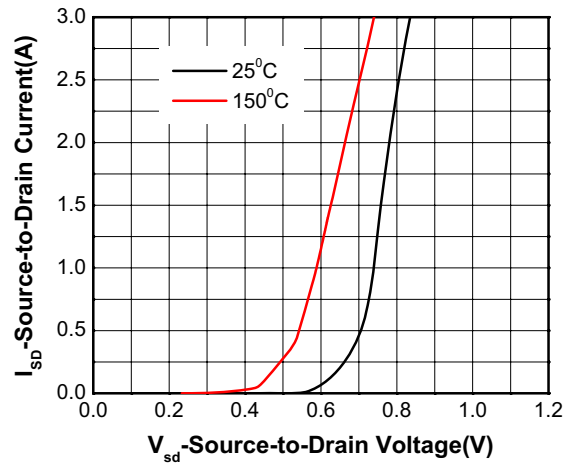
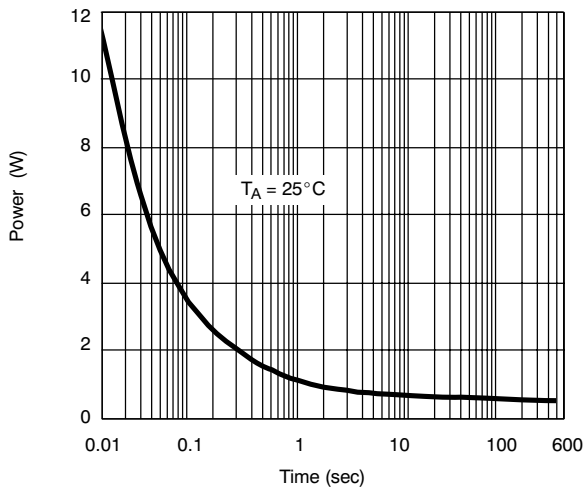
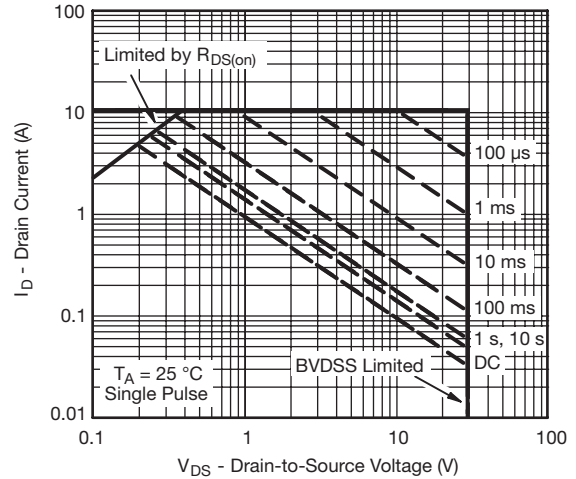
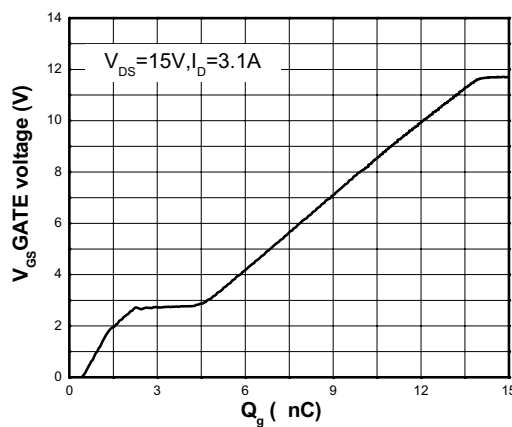
Output characteristics

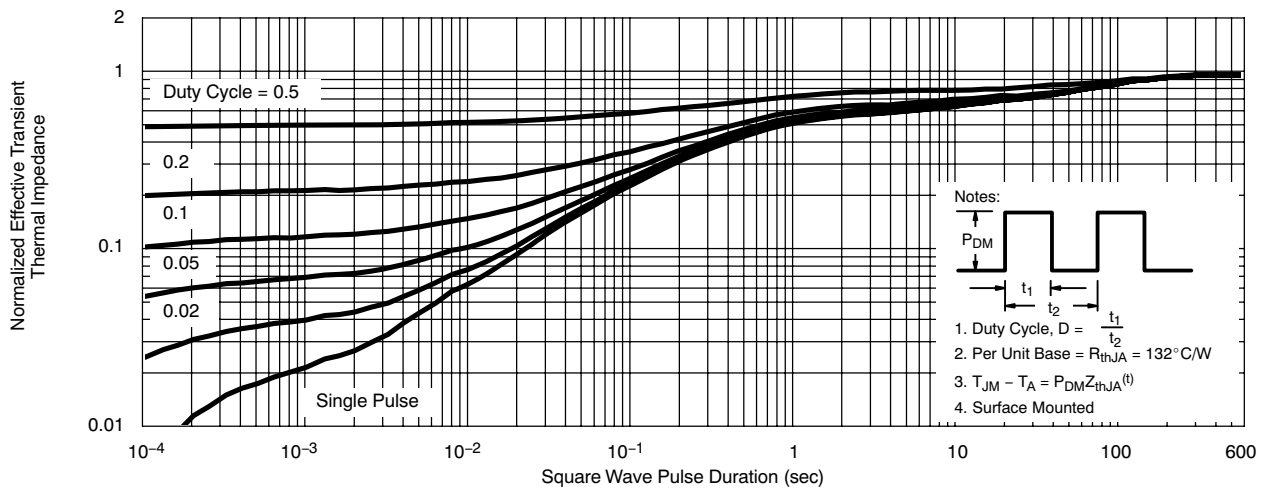
Transfer characteristics

On-Resistance vs. Drain current

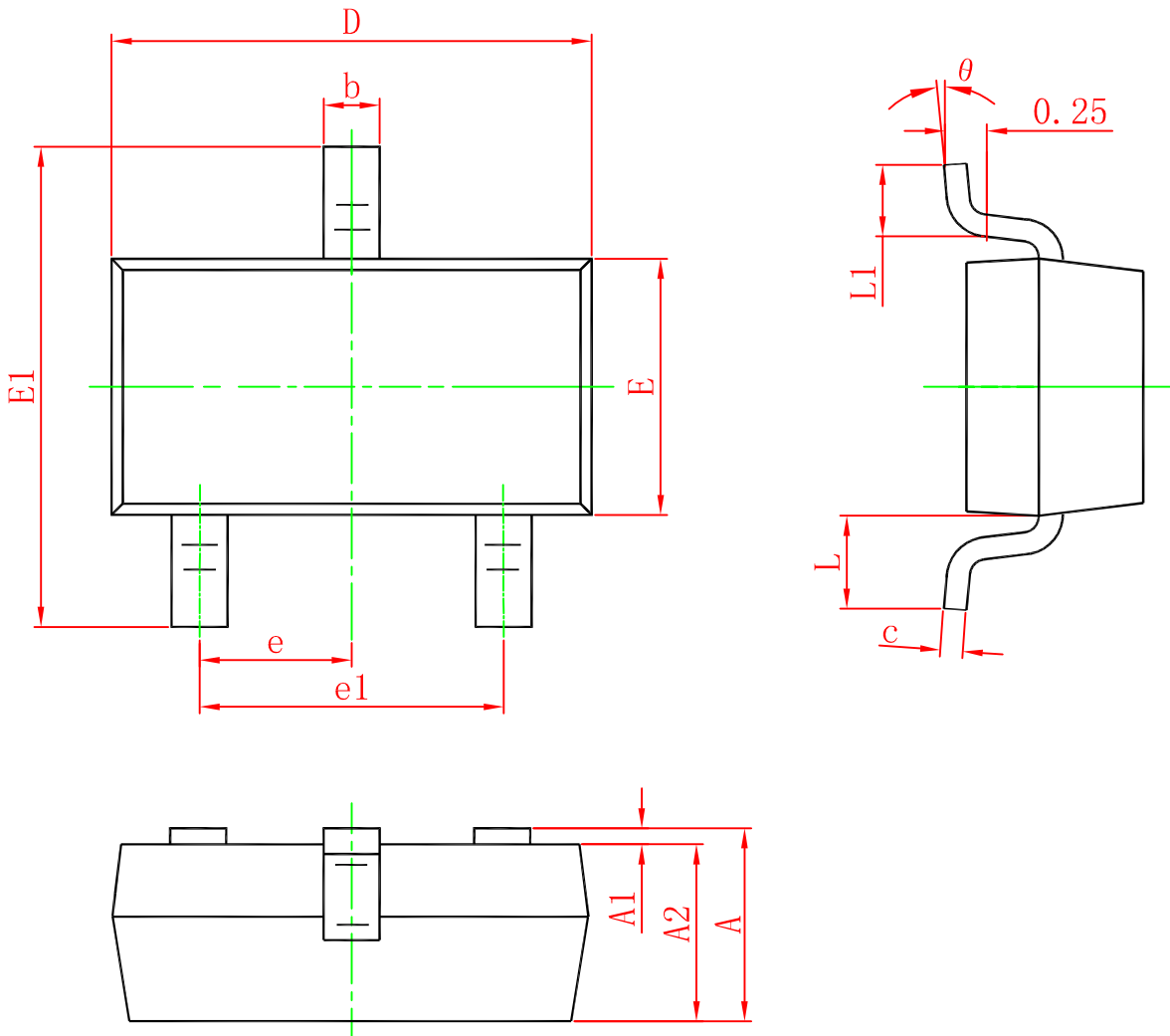
On-Resistance vs. Gate-to-Source voltage

On-Resistance vs. Junction temperature

Threshold voltage vs. Temperature

Capacitance

Body diode forward voltage

Single pulse power

Safe operating area

Gate Charge Characteristics



Transient thermal response (Junction-to-Ambient)

Package Outline Dimension
SOT-23

Symbol	Dimensions In Millimeters	
	Min.	Max.
A	0.900	1.150
A1	0.000	0.100
A2	0.900	1.050
b	0.300	0.500
c	0.080	0.150
D	2.800	3.000
E	1.200	1.400
E1	2.250	2.550
e	0.950 (Typ.)	
e1	1.800	2.000
L	0.550 (Typ.)	
L1	0.300	0.500
θ	0°	8°