

## CDBER42/43

**$I_o = 200 \text{ mA}$**   
 **$V_R = 30 \text{ Volts}$**   
**RoHS Device**

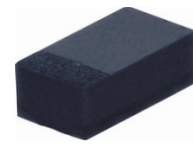

### Features

- Low forward voltage.
- Designed for mounting on small surface.
- Extremely thin/leadless package.
- Majority carrier conduction.

### Mechanical data

- Case: 0503/SOD-723F standard package, molded plastic.
- Terminals: Gold plated, solderable per MIL-STD-750, method 2026.
- Polarity: Indicated by cathode band.
- Mounting position: Any
- Weight: 0.002 gram(approx.).

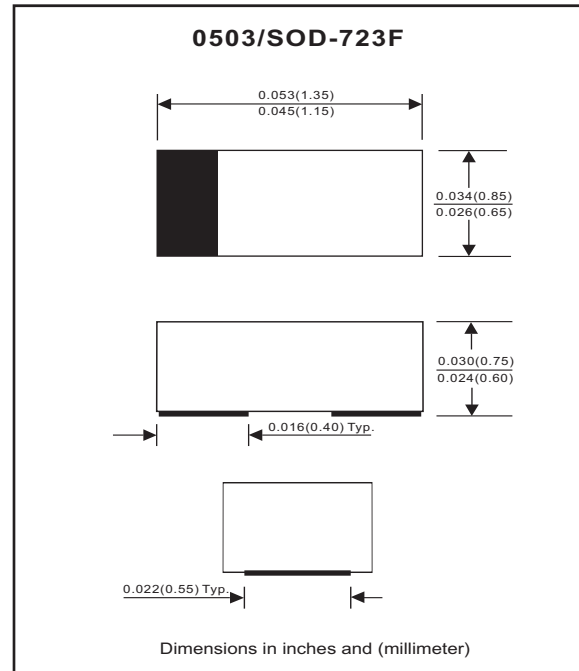

### Maximum Rating (at $T_A=25^\circ\text{C}$ unless otherwise noted)

Parameter	Conditions	Symbol	Min	Typ	Max	Unit
Peak reverse voltage		$V_{RM}$			30	V
Reverse voltage		$V_R$			30	V
RMS reverse voltage		$V_{R(RMS)}$			21	V
Average forward rectified current		$I_o$			200	mA
Repetitive peak forward current		$I_{FRM}$			0.5	A
Forward current, surge peak	8.3 ms single half sine-wave superimposed on rate load (JEDEC method)	$I_{FSM}$			4	A
Power dissipation		$P_D$			150	mW
Thermal resistance junction to ambient air		$R_{\theta JA}$			667	$^\circ\text{C}/\text{W}$
Storage temperature		$T_{STG}$	-55		+125	$^\circ\text{C}$
Junction temperature		$T_j$			+125	$^\circ\text{C}$

### Electrical Characteristics (at $T_A=25^\circ\text{C}$ unless otherwise noted)

Parameter	Conditions	Symbol	Min	Typ	Max	Unit
Forward voltage	CDBER42/43 $I_F = 200\text{mA}$ CDBER42 $I_F = 10\text{mA}$ CDBER42 $I_F = 50\text{mA}$ CDBER43 $I_F = 2\text{mA}$ CDBER43 $I_F = 15\text{mA}$	$V_F$			1 0.4 0.65 0.33 0.45	V
Reverse current	$V_R = 25\text{V}$	$I_R$			0.5	$\mu\text{A}$
Capacitance between terminals	$f = 1 \text{ MHz}$ , and 1 VDC reverse voltage	$C_T$			10	pF
Reverse recovery time	$I_F=I_R=10\text{mA}$ , $I_{rr}=0.1 \times I_R$ , $R_L=100 \text{ ohm}$	$T_{rr}$			5	nS

## RATING AND CHARACTERISTIC CURVES (CDBER42/43)

Fig. 1 - Forward characteristics

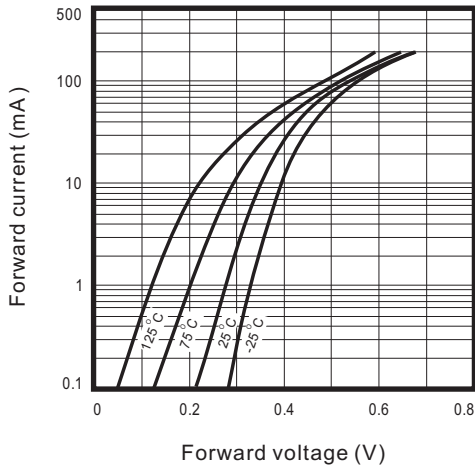

Fig. 2 - Reverse characteristics

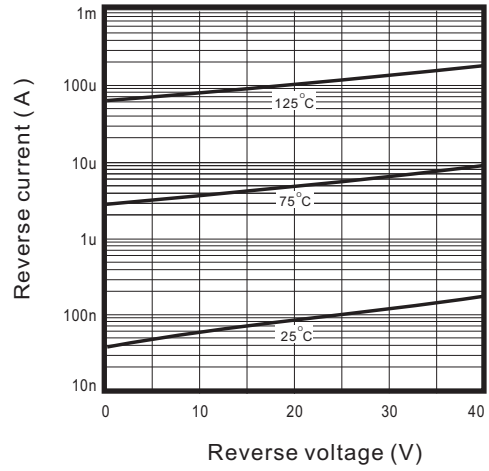

Fig.3 - Capacitance between terminals characteristics

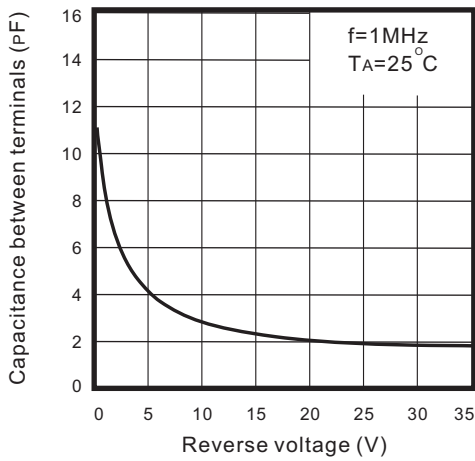
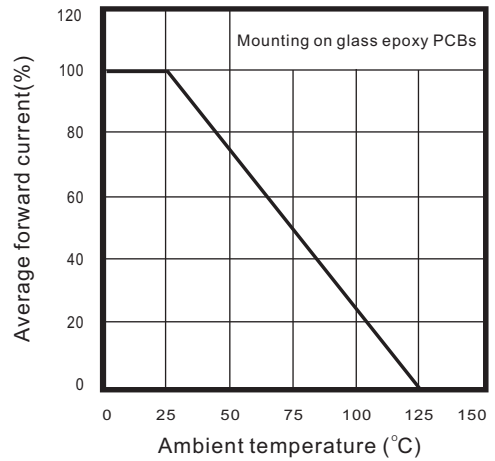
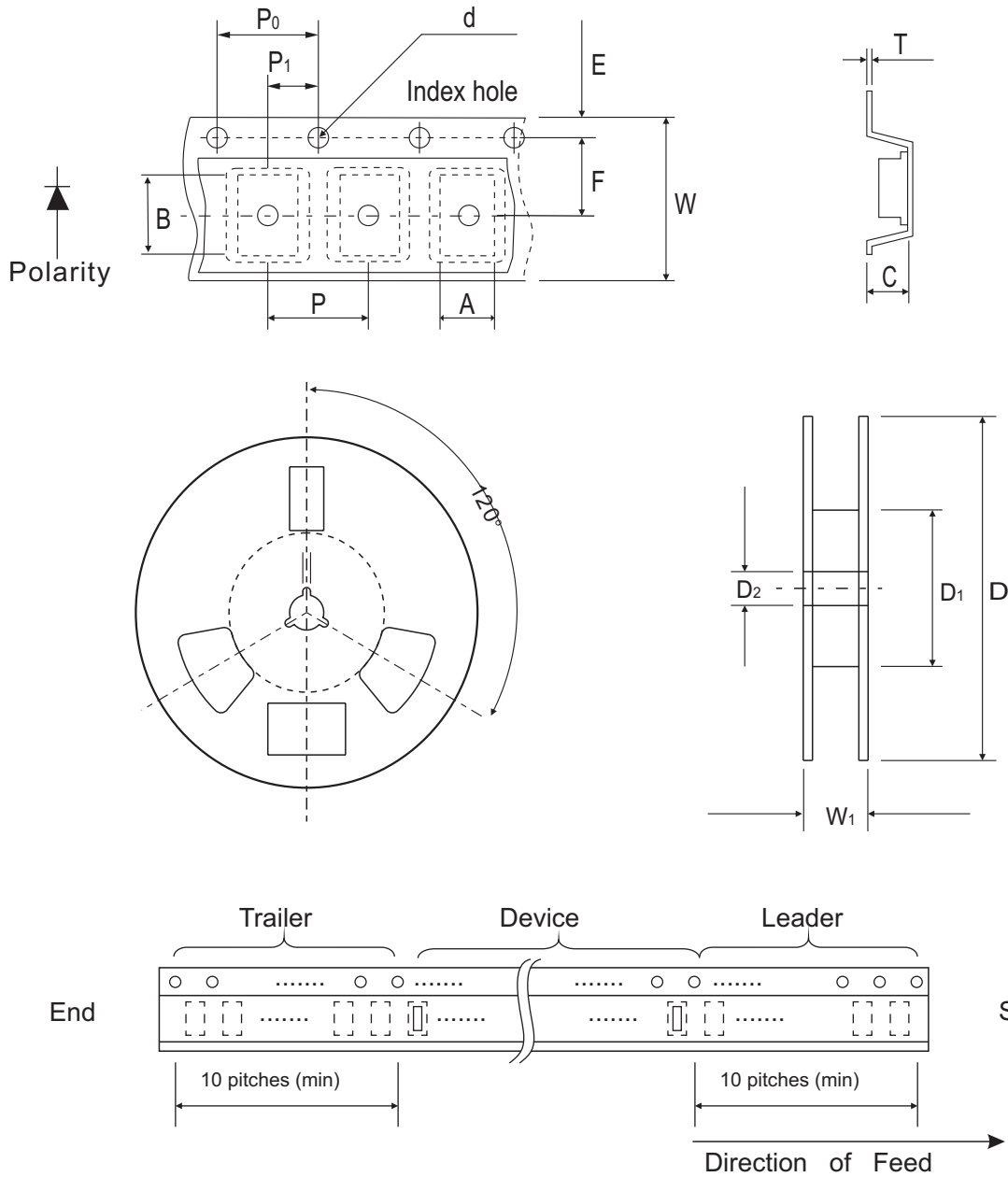

Fig.4 - Current derating curve



## Reel Taping Specification



0503 (SOD-723F)	SYMBOL	A	B	C	d	D	D <sub>1</sub>	D <sub>2</sub>
	(mm)	0.90 ± 0.10	1.46 ± 0.10	0.80 ± 0.10	1.55 ± 0.05	178 ± 1	60.0 MIN.	13.0 ± 0.20
	(inch)	0.035 ± 0.004	0.057 ± 0.004	0.031 ± 0.004	0.061 ± 0.002	7.008 ± 0.04	2.362 MIN.	0.512 ± 0.008

0503 (SOD-723F)	SYMBOL	E	F	P	P <sub>0</sub>	P <sub>1</sub>	T	W	W <sub>1</sub>
	(mm)	1.75 ± 0.10	3.50 ± 0.05	4.00 ± 0.10	4.00 ± 0.10	2.00 ± 0.10	0.22 ± 0.05	8.00 ± 0.20	13.5 MAX.
	(inch)	0.069 ± 0.004	0.138 ± 0.002	0.157 ± 0.004	0.157 ± 0.004	0.079 ± 0.004	0.008 ± 0.002	0.315 ± 0.008	0.531 MAX.

## Marking Code

Part Number	Marking Code
CDBER42	BD
CDBER43	BE



xx = Product type marking code

## Suggested PAD Layout

SIZE	0503/SOD-723F	
	(mm)	(inch)
A	0.85	0.033
B	0.55	0.022
C	0.85	0.033
D	1.40	0.055
E	0.30	0.012

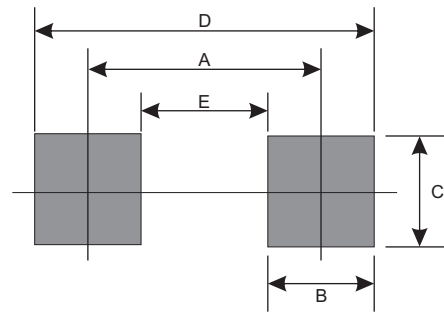

## Standard Package

Case Type	Qty per Reel	Reel Size
	(Pcs)	(inch)
0503/SOD-723F	4000	7