



DESCRIPTION:

480W AC-DC DIN RAIL Power Supply

The rated output power of TPR/SDR-480-XS series is 480W, input voltage range : 85-264VAC, output voltage : 24V,36V,48V, High reliability, efficiency, stable output voltage, etc., with short circuit & overload protection, Widely used in telecommunications, industrial control, signal control, instrumentation, data acquisition, New Energy, Security, and other electronic systems.

FEATURES

AC input : 85VAC-264VAC, DC input: 127-375VDC	Built-in DC OK relay contact	Operating temperature : -25°C ~70°C
Mounting track: TS-35/7.5 or TS-35/15	Protection: short circuit, over-load, over-voltage, over-temperature	Mini width: 70mm
RoHS complaint	100% full load burn-in test	Built-in current limiting circuit
Built-in active PFC, PF>0.95	Easy Fuse Tripping due to High Overload Current	150%(720W) peak load capacity
Built-in current sharing function	Support 1+1 or N+1 redundant system (suggest to use redundancy)	High efficiency up to 94%

SELECTION GUIDE

Part Number	Input Voltage			Output				Efficiency @25°C, (Typ) %
	(VAC)		(VDC)	Voltage (VDC)	Pre-set voltage @25°C (V)	Rated current (A)	Rated power(W)	
	Rated	Range	Rated					
TPR/SDR-480-24S	220	85-264	127-375	24	24.00-24.2	20	480	93.8
TPR/SDR-480-36S	220	85-264	127-375	36	36.0-36.3	13.3	478.8	93.8
TPR/SDR-480-48S	220	85-264	127-375	48	48.0-48.48	10	480	93.5

All specifications typical at TA=25°C, nominal input voltage and rated output current unless otherwise specified.

OUTPUT CHARACTERISTICS

Conditions	Conditions	Parameter
Output voltage regulation	24V output voltage	24-28V
	36V output voltage	36-42V
	48V output voltage	48-56V
Rated Output current	24V output voltage	20A at 24V
		17.2A at 28V
	36V output voltage	13.3A at 36V
		11.5A at 42V
48V output voltage	10A at 48V	
	8.6A at 56V	
Rated Output power	24V output voltage	480W/24V, 481.6W/28V
	36V output voltage	478.8W/36V, 483W/42V
	48V output voltage	480W/48V, 481.6W/56V
Ripple&Noise 0<Ta≤70°C	24V output voltage	≤240mVp-p
	36V 48V output voltage	≤480mVp-p
Ripple&Noise -25<Ta≤0°C	24V output voltage	≤480mVp-p
	36V 48V output voltage	≤480mVp-p
Capacitive load capacity	24V 36V 48V output voltage	10000uF
Line regulation @-25~70°C		±0.5%
Load regulation @-25~70°C		±1.0% @single ±5.0% @ parallel
Temp. coefficient @-25~70°C		±0.03%/°C
Set-up time @25°C		≤3S@ rated load
Hold-up time @25°C		≥20mS@ (230Vac input, rated load)
Overshoot&Undershoot		<5.0%

INPUT CHARACTERISTICS

Conditions	Parameter
Rated Input voltage range	100VAC~240VAC
Input voltage range	85VAC~264 VAC (300VAC max. at 10s)
Input voltage range	127VDC-375VDC
Frequency Range	47Hz~63Hz
Set-up voltage @-25~70℃	<85 VAC , <120VDC@24V ; <127VDC@48V
Input current @25℃	<3A/100VAC <1.5A/230VAC
Inrush current @25℃	<20A@110 Vac input <40A@230Vac input
Power factors@25℃	0.99/110VAC, 0.95/230VAC

PROTECTION

Conditions	Parameter	Notes
Over-Load	24Voutput	110%~150% of rated current, Constant current limiting for some time(150% of rated current, last 3S) then PS stop working for 7S,after 7S,if the load <=rated current, PS will work normally, auto recovery
Over-Load	36Voutput	
Over-Load	48Voutput	
Over-voltage (24Voutput)	29~33V	constant voltage, Auto recovery
Over-voltage (36Voutput)	43.5~47.25V	
Over-voltage (48Voutput)	58~63V	
Over-temperature	105±5℃, detect on heat sink of power transistor; shut down O/P, auto recovery after temperature goes down	
Output short circuit protection	Long-term model , auto recovery	

ENVIRONMENT CHARACTERISTICS

Conditions	Parameter
Operating amb. Temp.&Humi.	-25℃~70℃; 20%~90%RH No condensing 50℃~70℃ derating
Storage Temp. & Humi.	-40℃~85℃; 5%~95%RH No condensing
Vibration	10 ~ 500Hz, 2G, 10min./1cycle, each along X,Y, Z axes IEC 60068-2-6
Pulse	20G/11mS pulse ,3 times at each X,Y,Z axes IEC 60068-2-27
Altitude	6000m

SAFETY&EMC STANDARDS @25℃

Conditions	Parameter
Safety Standards	meet UL508, UL60950, EN60950
Withstand Voltage(24V/48V)	I/P-O/P:3.0KVac/10mA; I/P-FG:2.5KVac/10mA; O/P-FG:0.5KVdc/20mA O/P- DC OK :0.5KVdc/1mA Test time:1min.
Withstand Voltage(36V)	I/P-O/P:3.0KVac/15mA; I/P-FG:2.5KVac/15mA; O/P-FG:0.5KVdc/20mA O/P- DC OK :0.5KVdc/1mA Test time:1min.
Isolation resistance	1I/P-O/P: 10M ohms; I/P-FG : 10M ohms; O/P-FG : 10M ohms
Grounding test	32A / 2min Grounding resistance: <0.1 ohms
Leakage Current @ 25℃	I/P-Grounding≤3.5mA; I/P-O/P ≤0.25mA (264Vac input, 63Hz)
EMC emission	Compliance to EN55022, EN55024, FCC PART 15 CLASS B
EMC immunity	Compliance to EN61000-4-2,3,4,5,6,11 heavy industry level
Harmonic current	EN61000-3-2, CLASS A

OTHERS

Conditions	Parameter
Net Weight	1.2kg Dimension (L*W*H) 70*124*127mm
Cooling method	Cooling by free air flow
Parallel function	yes

OTHERS

DC OK relay contact rating	Max 30V/1A or 60V/0.3A or 30Vac/0.3A Resistive load
DC OK LED	V On: when output voltage is up to 90% of rated output voltage, V Off: when output voltage is down to 80% of rated output voltage
Power boost	150% of rated current

RELIABILITY CHARACTERISTICS

Conditions	Parameter
MTBF	300, 000Hrs AT 25°C, MIL-217 Method 2 Components Stress Method
Design electrolytic capacitor life-time	>5years AT 40°C 230VAC input 100% output

MECHANICAL DIMENSIONS

Unit:mm

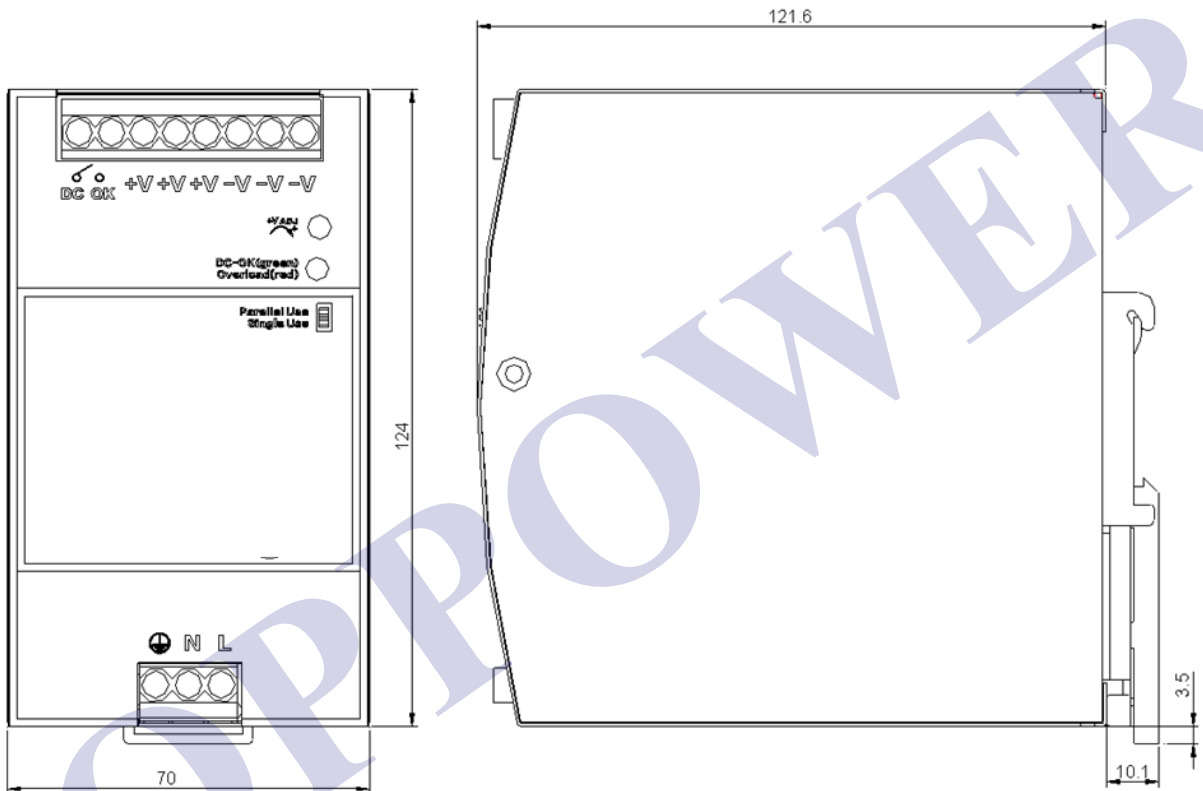

1.AC terminal blocks installation information		
Terminal No.	Function	Specs
1	PG	6.35mm, 3pin screw terminal blocks
2	N	
3	L	

2.DC terminal blocks installation information		
Terminal No.	Function	Specs
1	DC	6.35mm, 3pin screw terminal blocks
2	OK	
3~5	V+	
6~8	V-	

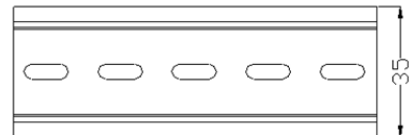

Mounting way: TS35/7.5 or TS35/15

	AC/DC Terminal
Type	Screw terminal blocks
Solid Wire	0.5-6mm ²
Strand Wire	0.5-4mm ²
Wire Spec	AWG20-10 (PG wire >18AWG)
Max Wire Diameter	2.8mm
Recommended stripping length	7mm
Screwdriver	3.5mm Straight or Cross Screwdriver
Recommended Torque	1NM

CHARACTERISTICS CURVE

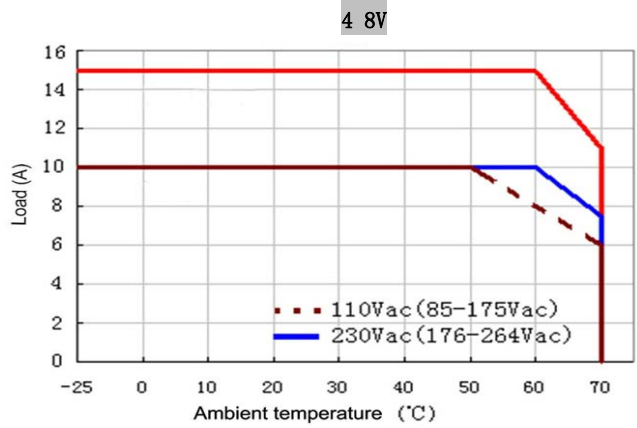
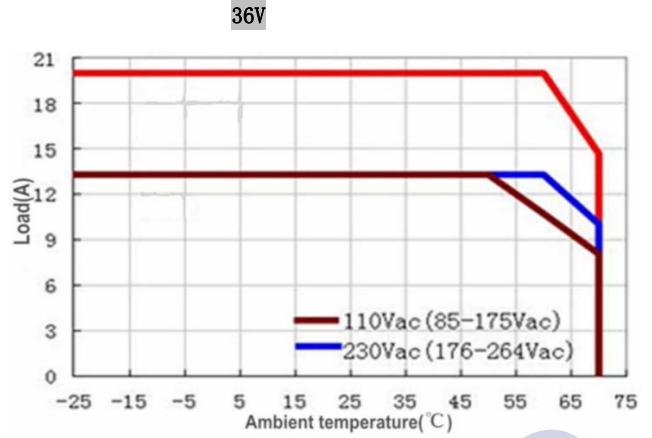
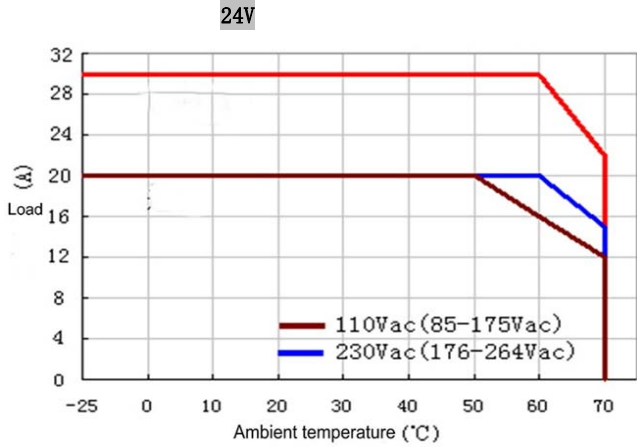

— short time working, 3S
 — continuous working

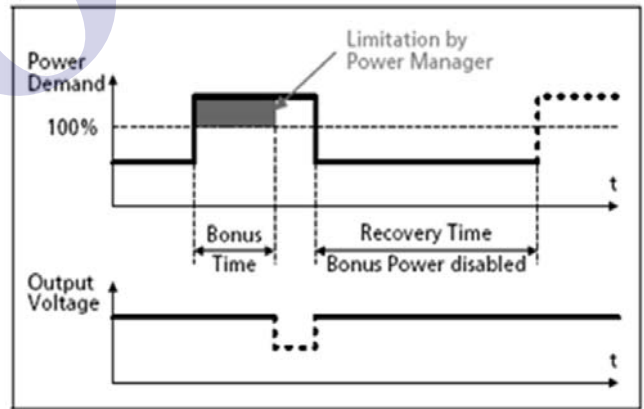
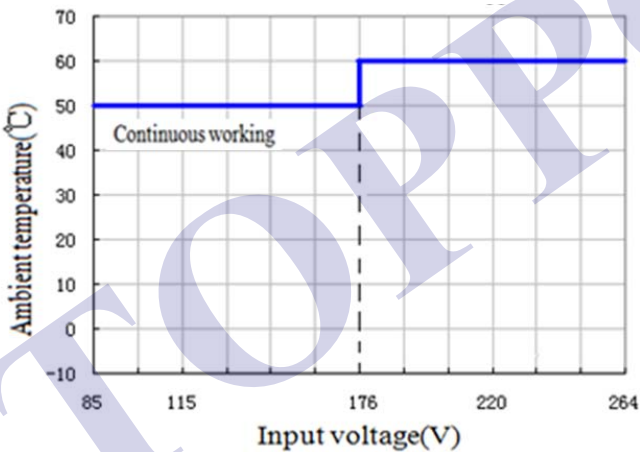

Power-on

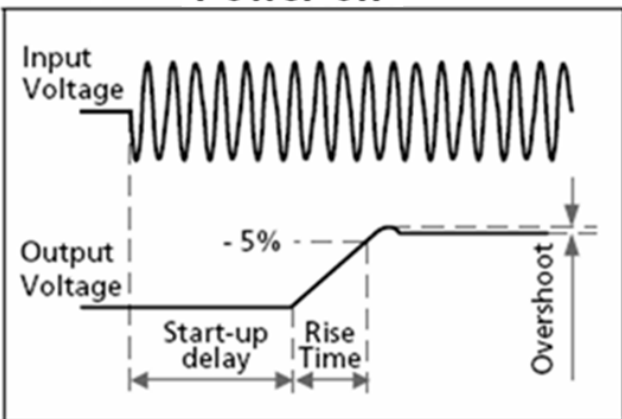

Power-off

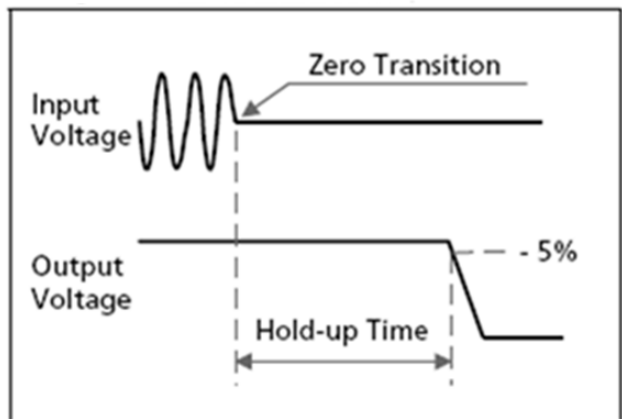

MOUNTING METHOD INSTRUCTION

A1 is recommended output current , A2 is the allowed max output current (PSU lifetime is around half of A1)

Below curves are tested under 230Vac(179~264Vac), when 110Vac input(85~175Vac), all derating points drops 10°C

24V output

Mounting 1:

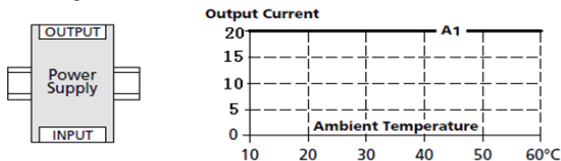

Mounting 2:

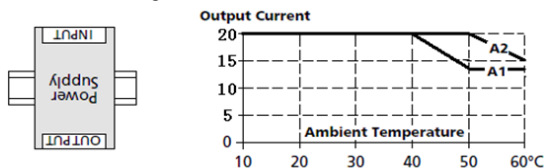

Mounting 3:

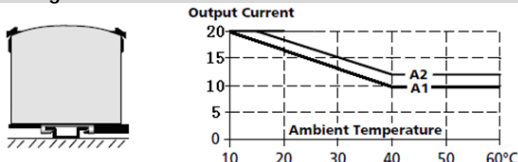

Mounting 4:

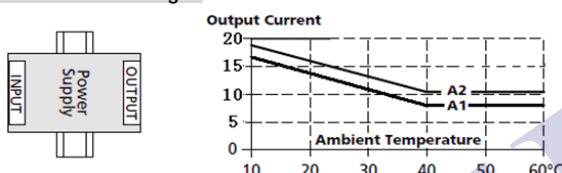

Mounting 5:

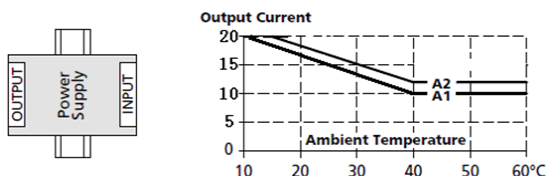

36V output

Mounting 1:

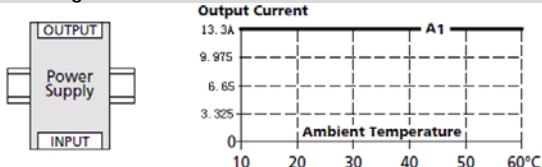

Mounting 2:

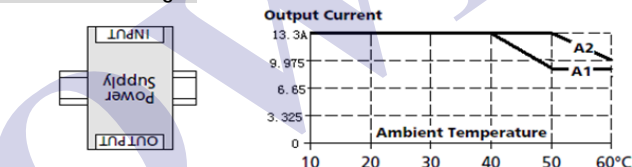

Mounting 3:

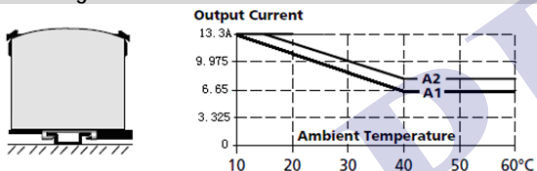

Mounting 4:

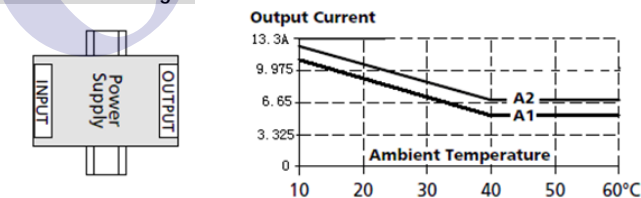

Mounting 5:

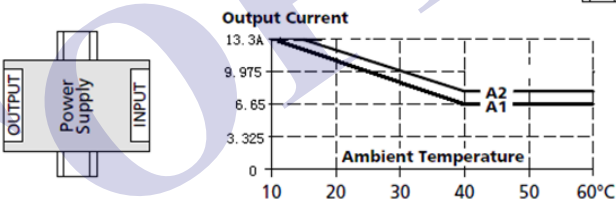

48V output

Mounting 1:

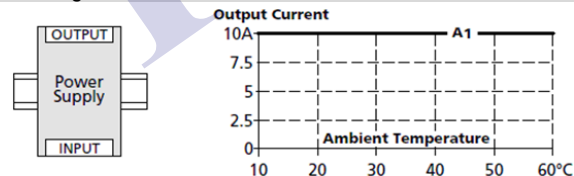

Mounting 2:

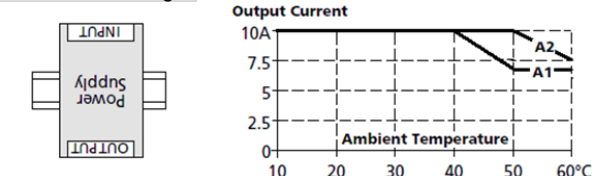

Mounting 3:

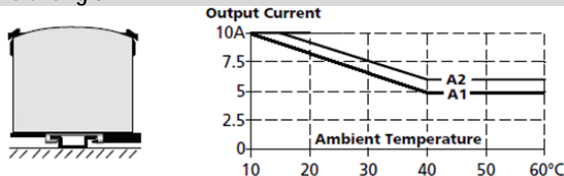

Mounting 4:

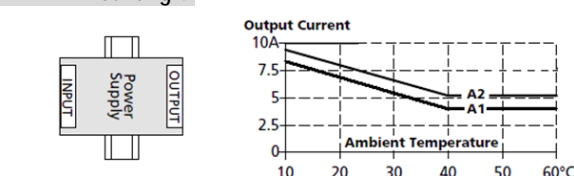

Mounting 5:

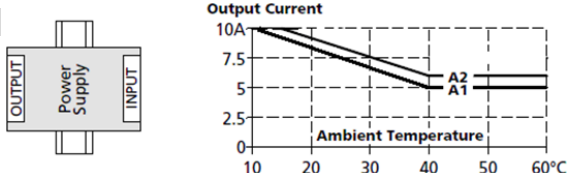

BLOCK DIAGRAM

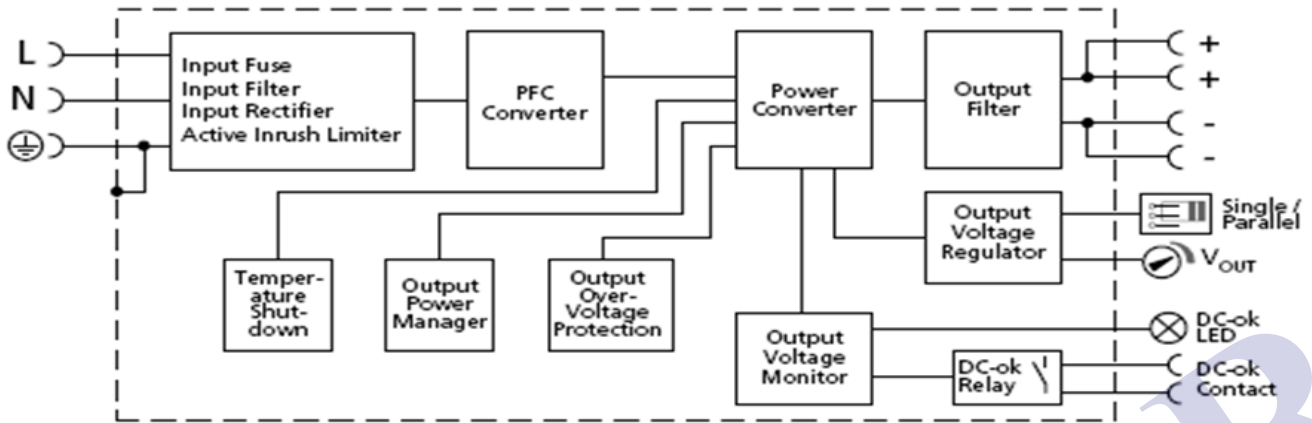

MODEL SELECTION

TP R / SDR -480 - X S

