

Features

- * 350W peak pulse power (8/20 μ s)
- * Protects one data or power line
- * Ultra low leakage: nA level
- * Operating voltage: 24V
- * Ultra low clamping voltage
- * Complies with following standards:
 - IEC 61000-4-2 (ESD) immunity test
Air discharge: ± 30 kV
Contact discharge: ± 30 kV
 - IEC61000-4-5 (Lightning) 7A (8/20 μ s)
 - IEC61000-4-4 (EFT) 40A (5/50ns)
- * RoHS Compliant

Mechanical Characteristics

- * Package: SOD-323
- * Lead Finish: Matte Tin
- * Case Material: "Green" Molding Compound.
- * UL Flammability Classification Rating 94V-0
- * Moisture Sensitivity: Level 3 per J-STD-020
- * Terminal Connections: See Diagram Below
- * Shipping Qty :3000 /7Inch Tape & Reel

Applications

- * Cellular Handsets and Accessories
- * Personal Digital Assistants
- * Notebooks and Handhelds
- * Portable Instrumentation
- * Peripherals
- * Pagers Peripherals
- * Desktop and Servers

Dimensions and Pin Configuration

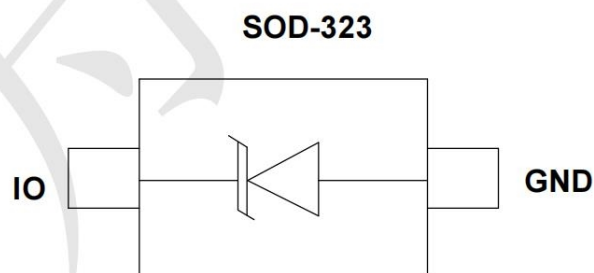

Marking: D24 Or 24W

Absolute Maximum Ratings (Tamb=25°C unless otherwise specified)

Parameter	Symbol	Value	Unit
Peak Pulse Power (8/20μs)	Ppk	350	W
Peak Pulse Current (8/20μs)	I _{PP}	7	A
ESD per IEC 61000-4-2 (Air)	V _{ESD}	±30	kV
ESD per IEC 61000-4-2 (Contact)		±30	
Operating Temperature Range	T _J	-55 to +125	°C
Storage Temperature Range	T _{stg}	-55 to +150	°C

Electrical Characteristics (TA=25°C unless otherwise specified)

Parameter	Symbol	Min	Typ	Max	Unit	Test Condition
Reverse Working Voltage	V _{RWM}			24	V	
Breakdown Voltage	V _{BR}	26.7			V	I _T = 1mA
Reverse Leakage Current	I _R			0.5	μA	V _{RWM} = 24V
Forward Voltage	V _F		0.8	1.2	V	I _F = 10mA
Clamping Voltage	V _C			9	V	I _{PP} = 1A (8 x 20μs pulse)
Clamping Voltage	V _C		40	50	V	I _{PP} = 7A (8 x 20μs pulse)
Junction Capacitance	C _J			50	pF	V _R = 0V, f = 1MHz

Typical Performance Characteristics (TA=25°C unless otherwise Specified)

Fig1. 8/20μs Pulse Waveform

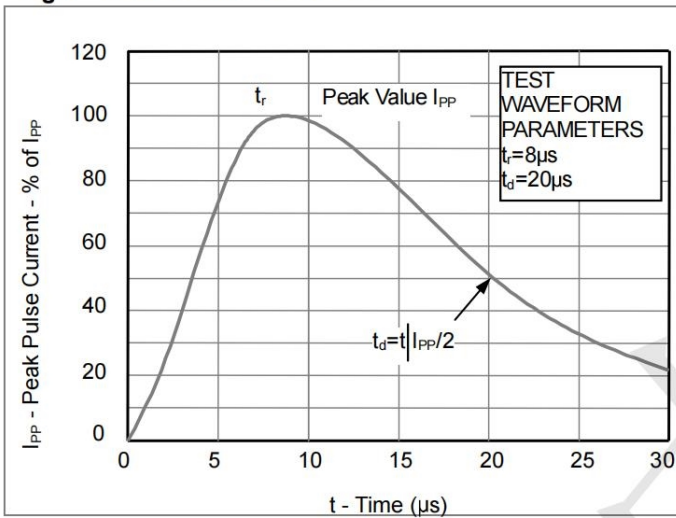

Fig2. ESD Pulse Waveform (according to IEC 61000-4-2)

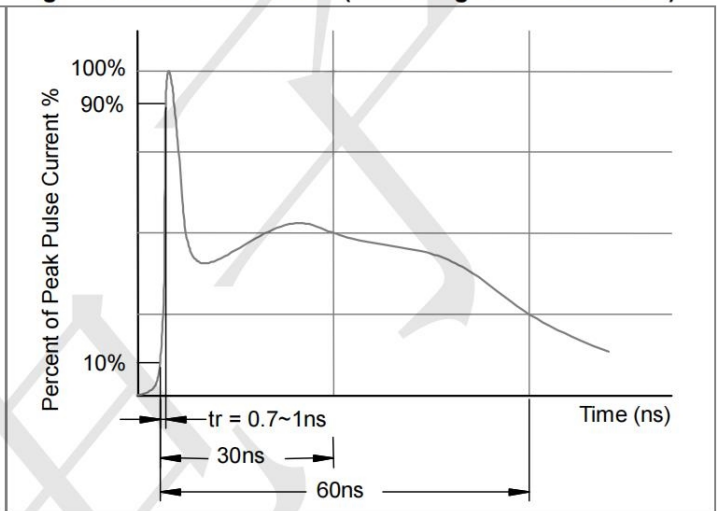
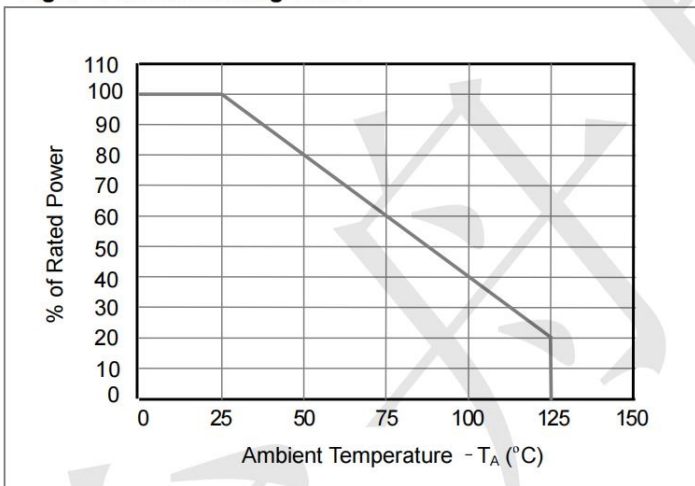
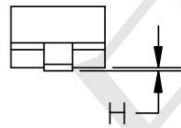
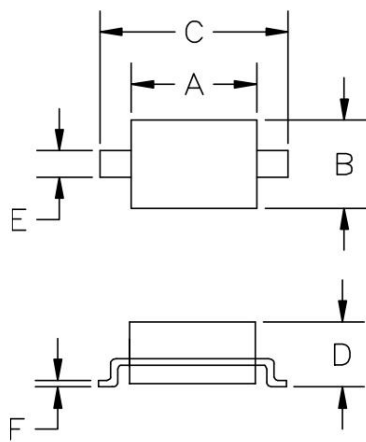

Fig3. Power Derating Curve



Outline Drawing - SOD-323



SYM	DIMENSIONS			
	MILLIMETERS		INCHES	
	MIN	MAX	MIN	MAX
A	1.50	1.80	0.060	0.071
B	1.20	1.40	0.045	0.054
C	2.30	2.70	0.090	0.107
D	-	1.10	-	0.043
E	0.30	0.40	0.012	0.016
F	0.10	0.25	0.004	0.010
H	-	0.10	-	0.004

Land Pattern - SOD-323

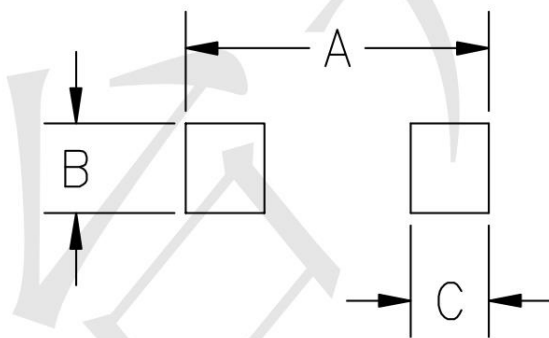

SYM	DIMENSIONS	
	MILLIMETERS	INCHES
A	3.15	0.120
B	0.80	0.031
C	0.80	0.031