



PARA LIGHT ELECTRONICS CO., LTD.

4F, No.1, Lane 93, Chien Yi Road, Chung Ho City, Taipei, Taiwan.

Tel: 886-2-2225-3733

Fax: 886-2-2225-4800

E-mail: para@para.com.tw

<http://www.para.com.tw>

DATA SHEET

PART NO.: L-C155TBJSCT-5A

REV: A/0

CUSTOMER'S APPROVAL: _____

DCC: _____

DRAWING NO.: DS-31-09-XXXX

DATE: 2009-06-30

PAGE 1 of 13



SURFACE MOUNT DEVICE LED

Part No.: L-C155TBJSCT-5A

REV:A/0

● PACKAGE OUTLINE DIMENSIONS

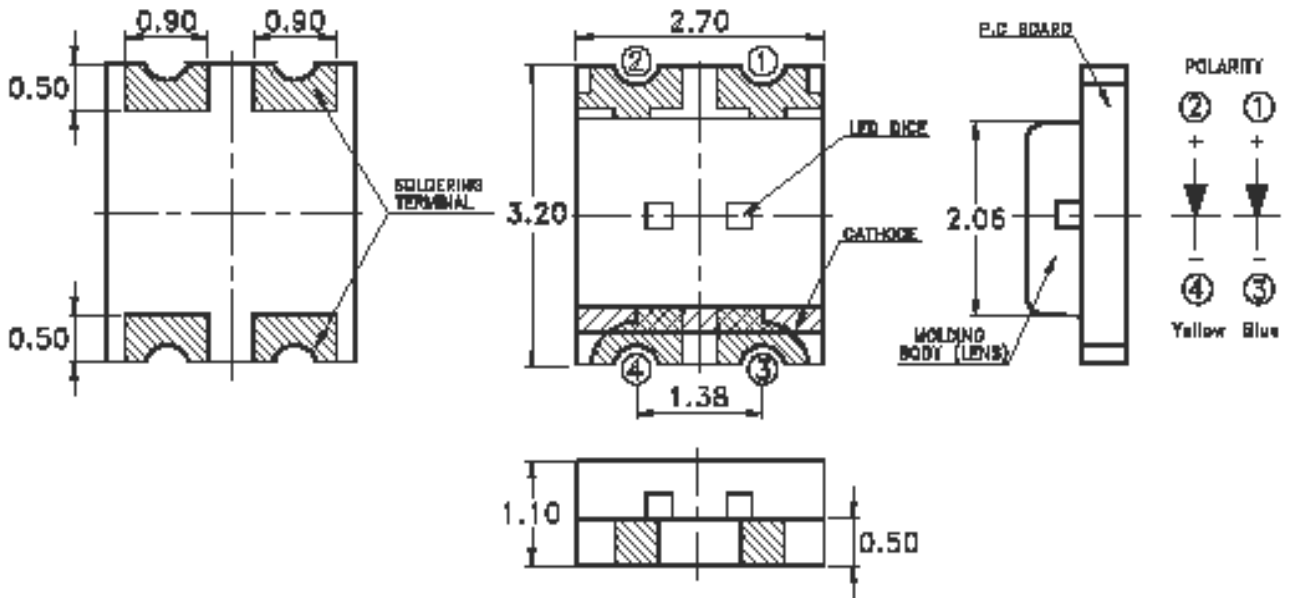

Notes:

1. ②④: Yellow; ①③:Blue
2. All dimensions are in millimeters.
3. Tolerance is $\pm 0.1\text{mm}$ (.004") unless otherwise noted.

● Features

- * Dual color, top view, wide view angle Chip LED.
- * Package in 8mm tape on 7" diameter reels.
- * Compatible with automatic Pick & Place equipment.
- * Compatible with Reflow soldering and Wave soldering processes.
- * EIA STD package.
- * I.C. compatible.
- * Pb free product.



SURFACE MOUNT DEVICE LED

Part No.: L-C155TBJST-5A

REV:A/0

● Chip Materials

Chip	Light Color	Dice Material	Lens Color
①③	TB:Blue	InCaN	Water Clear
②④	JS: Yellow	AlInCaP	

● Absolute Maximum Ratings (Ta=25°C)

Symbol	Parameter	Rating		Unit
		Blue	Yellow	
P _D	Power Dissipation	76	75	mW
I _{PF}	Peak Forward Current (1/10 Duty Cycle, 0.1ms Pulse Width)	100	80	mA
I _F	Continuous Forward Current	20	30	mA
-	De-rating Linear From 25°C	0.25	0.4	mA/°C
V _R	Reverse Voltage	5	5	V
ESD	Electrostatic Discharge Threshold (HBM) ^{Note A}	2000		
T _{opr}	Operating Temperature Range	-20 ~ +80		°C
T _{stg}	Storage Temperature Range	-30 ~ +100		°C
-	Wave Soldering Condition (Two times Max.)	260 (for 5 seconds)		°C
-	Infrared Soldering Condition (Two times MAX.)	260 (for 10 seconds)		°C

Note A:

HBM: Human Body Model. Seller gives no other assurances regarding the ability of to withstand ESD.

● Electro-Optical Characteristics (Ta=25°C)

Parameter	Symbol	Blue	Yellow	Unit	Test Condition	
Luminous Intensity	Min.	4.5	4.5	mcd	IF=5mA	
	Typ.					
	Max.	45.0	45.0			
Viewing Angle	Typ.	2θ 1/2		deg	Note 2	
Peak Wavelength	Typ.	λ _p	468	591	nm	Measurement @Peak
Dominant Wavelength	Typ.	λ _d	470	589	nm	IF=5mA
Spectral Line Half-Width	Typ.	Δλ	25	15	nm	
Forward Voltage	Typ.	VF	3.1	2.0	V	IF =5mA
	Max.		3.6	2.4		
Reverse Current	Max.	IR	10		μA	VR = 5V



SURFACE MOUNT DEVICE LED

Part No.: L-C155TBJ SCT-5A

REV:A/0

Notes:

1. Luminous intensity is measured with a light sensor and filter combination that approximates the CIE eye-response curve.
2. $\theta_{1/2}$ is the off-axis angle at which the luminous intensity is half the axial luminous intensity.
3. The dominant wavelength λ_d is derived from the CIE chromaticity diagram and represents the single wavelength which defines the color of the device.
4. Caution in ESD:
Static Electricity and surge damages the LED. It is recommended use a wrist band or anti-electrostatic glove when handling the LED. All devices, equipment and machinery must be properly grounded.
5. Major standard testing equipment by "Instrument System" Model: CAS140B Compact Array Spectrometer and "KEITHLEY" Source Meter Model: 2400.

● Typical Electro-Optical Characteristics Curves

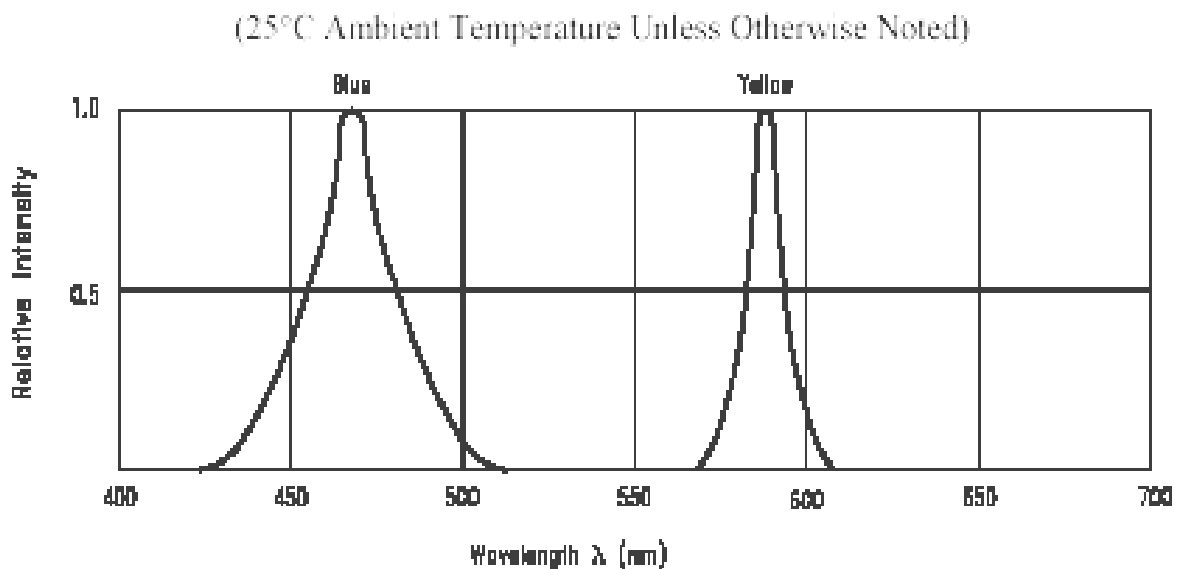

Fig.1 Relative Intensity vs. Wavelength



SURFACE MOUNT DEVICE LED

Part No.: L-C155TBJST-5A

REV:A/0

● Blue and Yellow Typical Electro-Optical Characteristics Curves

(25°C Ambient Temperature Unless Otherwise Noted)

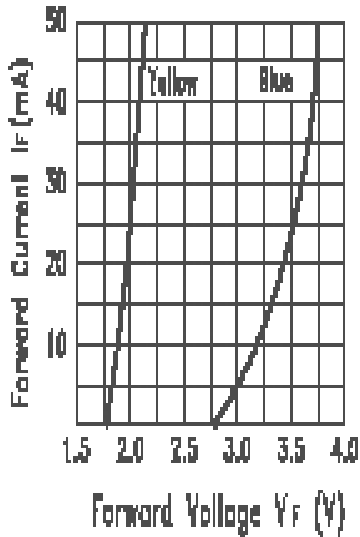

Fig.2 Forward Current vs. Forward Voltage

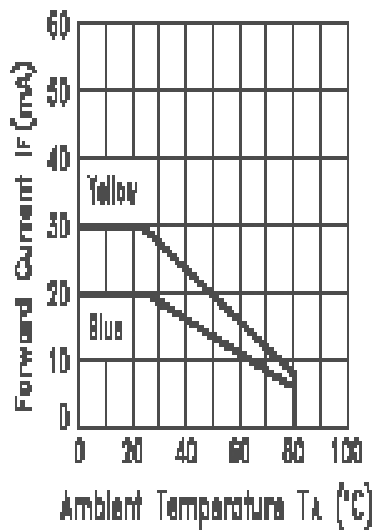

Fig.3 Forward Current Derating Curve

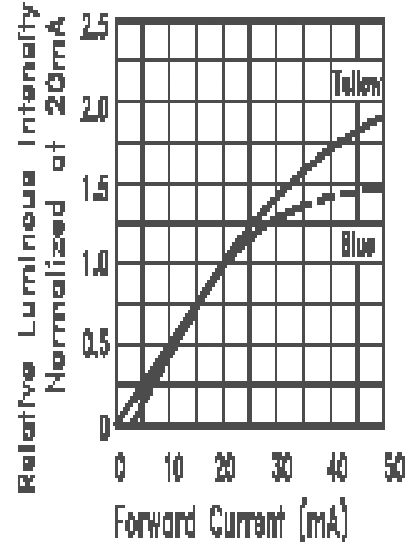

Fig.4 Relative Luminous Intensity vs. Forward Current

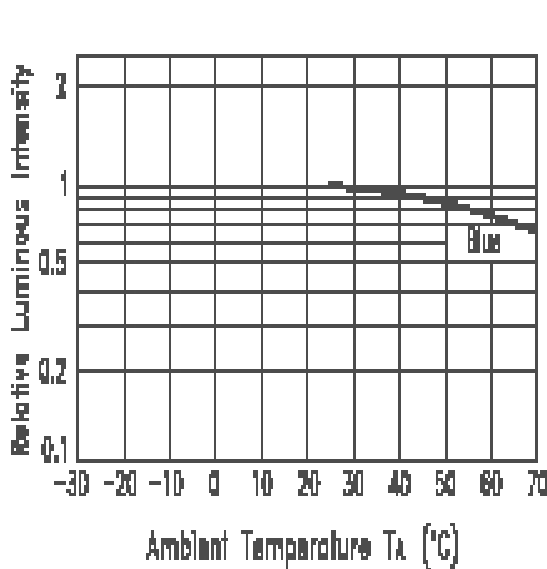

Fig.5 Luminous Intensity vs.

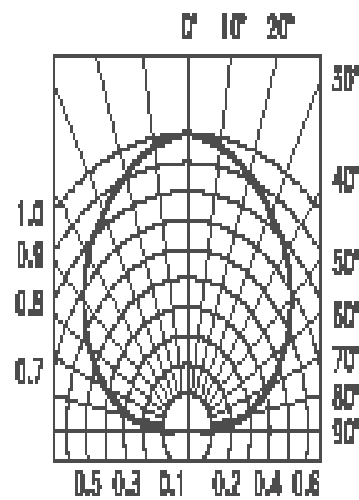

Fig.6 Spatial Distribution



SURFACE MOUNT DEVICE LED

Part No.: L-C155TBJ SCT-5A

REV:A/0

● Label Explanation



CUS. PART NO: To be denominated.

CUSTOMER: To be denominated.

PART NO: Refer to P15

BATCH: MNGA

M--- a Chip Luminous Intensity Code

N--- b Chip Luminous Intensity Code

GA--- a Chip Dominant Wavelength Code

LOT NO: E L S 4 7 0009
 A B C D E F

A---E: For series number

B---L: Local F: Foreign

C---S: SMD

D---Year

E---Month

F---SPEC.

QUANTITY:

3000pcs for 150、110、155、115、195 series

4000pcs for 191 series

5000pcs for 192 series



SURFACE MOUNT DEVICE LED

Part No.: L-C155TBJST-5A

REV:A/0

● Reel Dimensions

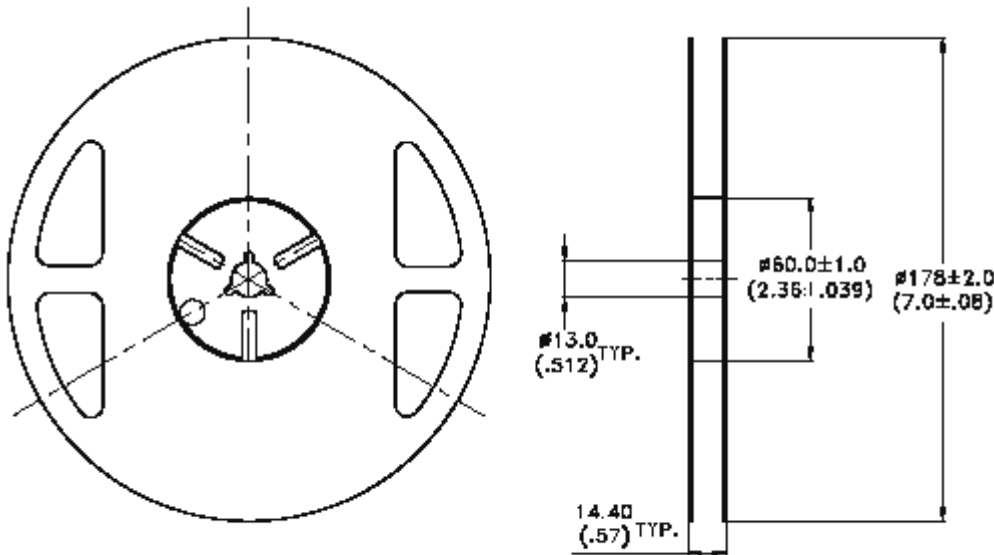

Notes:

1. Empty component pockets sealed with top cover tape.
2. 7 inch reel-3000 pieces per reel.
3. Minimum packing quantity is 500 pcs for remainders.
4. The maximum number of consecutive missing lamps is two.
5. In accordance with ANSI/EIA 481-1-A-1994 specifications.



SURFACE MOUNT DEVICE LED

Part No.: L-C155TBJST-5A

REV:A/0

● Package Dimensions Of Tape And Reel

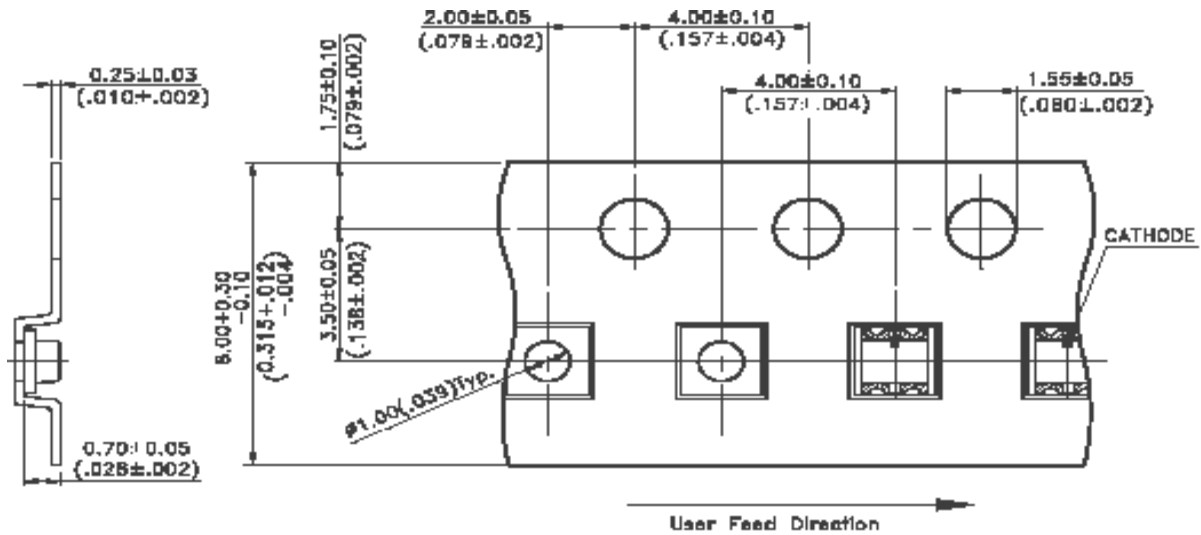

Notes: All dimensions are in millimeters.

Moisture Resistant Packaging

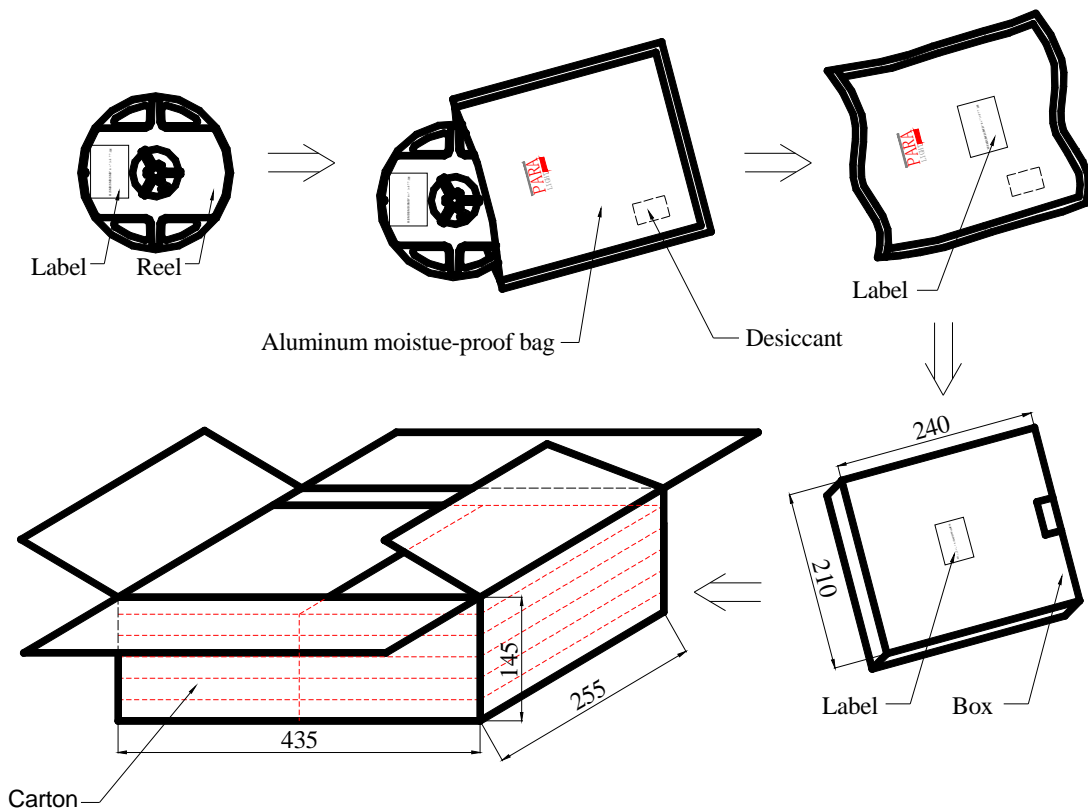

Notes: One reel in a bag, one bag in a inner box, ten inner boxes in a carton. Unit: mm.



SURFACE MOUNT DEVICE LED

Part No.: L-C155TBJST-5A

REV:A/0

● Cleaning

- * If cleaning is required, use the following solutions for less than 1 minute and less than 40°C.
- * Appropriate chemicals: Ethyl alcohol and isopropyl alcohol.
- * Effect of ultrasonic cleaning on the LED resin body differs depending on such factors as the oscillator output, size of PCB and LED mounting method. The use of ultrasonic cleaning should be enforced at proper output after confirming there is no problem.

● Suggest Soldering Pad Dimensions

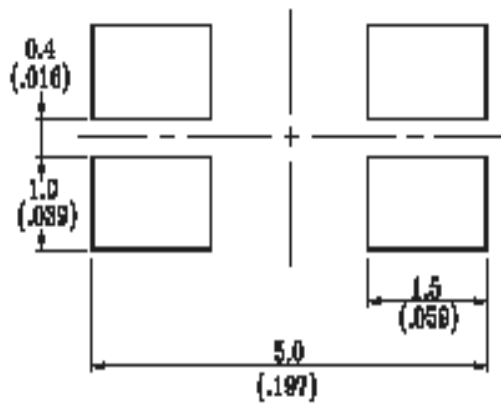

Direction of PWB camber
and go to reflow furnace



SURFACE MOUNT DEVICE LED

Part No.: L-C155TBJST-5A

REV:A/0

(1) Suggestion IR Reflow Profile For Normal Process

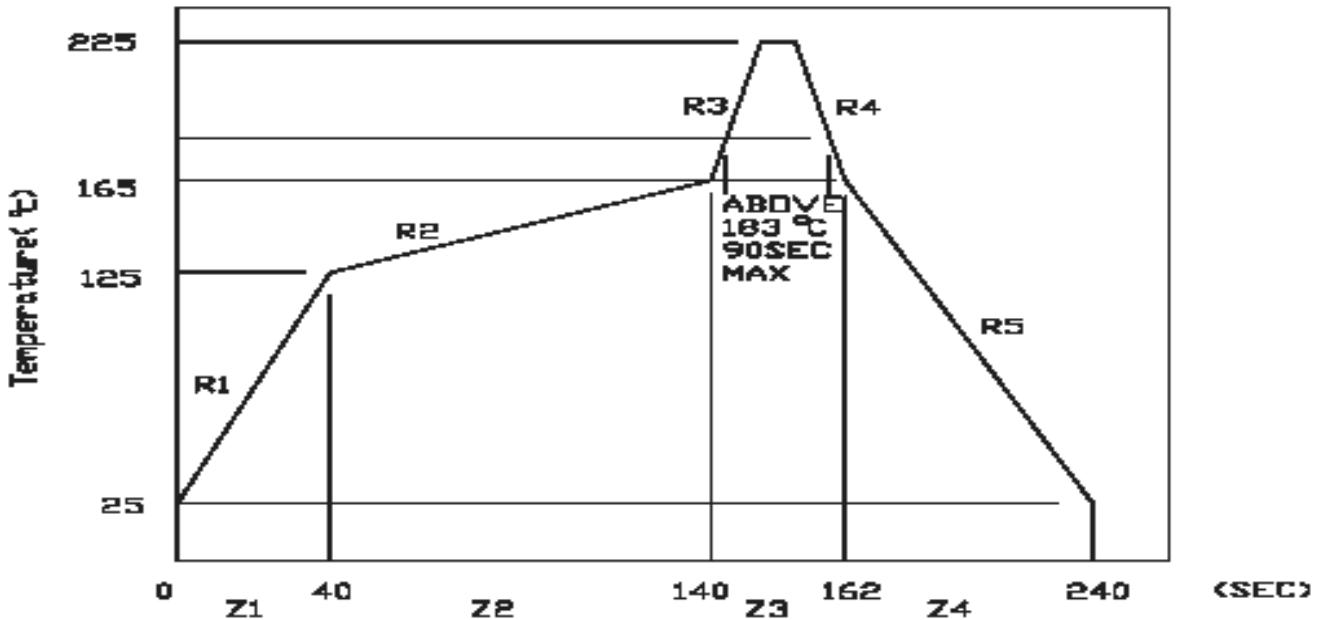

(2) Suggestion IR Reflow Profile For Pb Free Process

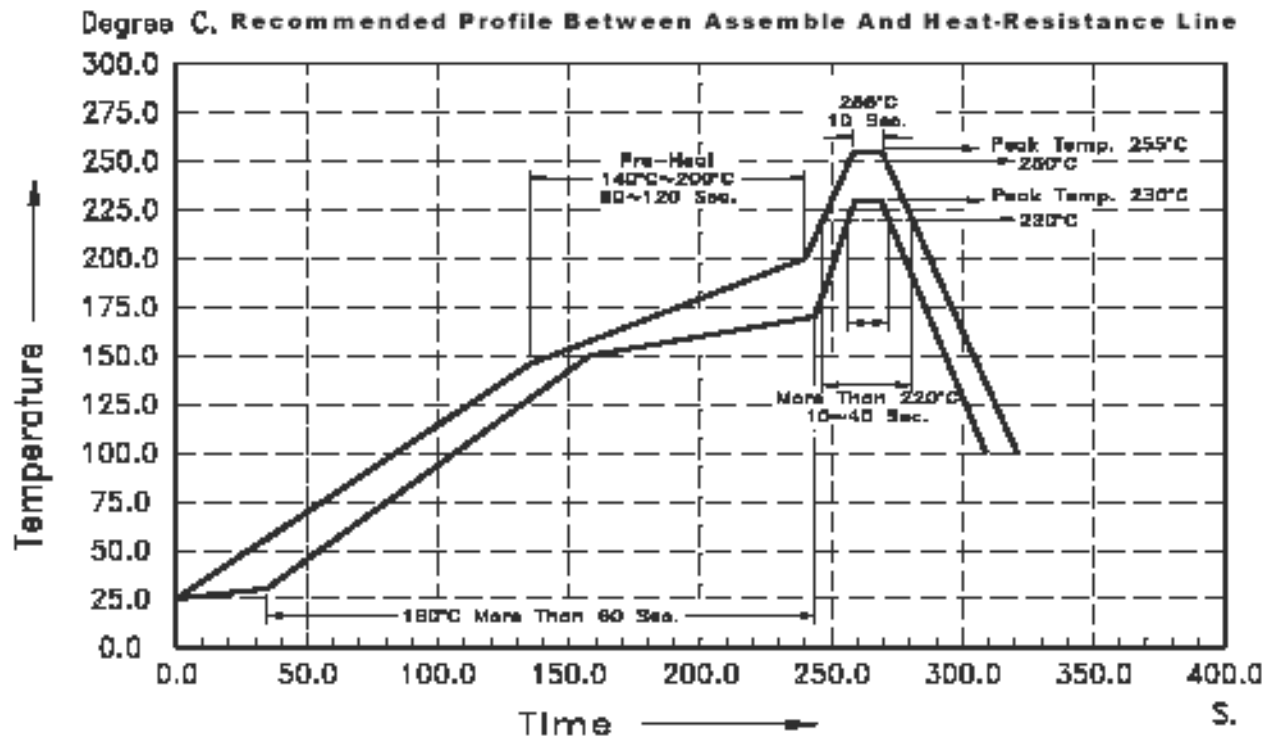

The Profile is available that must to use SnAg (x=3.3~3.8) Cu (y=0.2~0.7) solder paste



SURFACE MOUNT DEVICE LED

Part No.: L-C155TBJST-5A

REV:A/0

● Bin Code List

Luminous Intensity			Color : <u>Blue</u> , Unit : mcd @5mA		
Bin Code	Min.	Max.			
J	4.50	7.10			
K	7.10	11.20			
L	11.20	18.00			
M	18.00	28.00			
N	28.00	45.00			

Tolerance on each Intensity bin is +/-15%

Luminous Intensity			Color : <u>Yellow</u> , Unit : mcd @5mA		
Bin Code	Min.	Max.			
J	4.50	7.10			
K	7.10	11.20			
L	11.20	18.00			
M	18.00	28.00			
N	28.00	45.00			

Tolerance on each Intensity bin is +/-15%

● CAUTIONS

1.Application Limitation:

The LED's described here are intended to be used for ordinary electronic equipment (such as office equipment, communication equipment and household application). Consult PARA's sales in advance for information on application in which exceptional quality and reliability are required, particularly when the failure or malfunction of the LED's may directly jeopardize life or health (such as airplanes, automobiles, traffic control equipment, life support system and safety devices).

2.Storage:

Before opening the package:

The LEDs should be kept at 5°C to 30°C or less and 85%RH or less. The LEDs should be used within a year.

After opening the package:

The LEDs should be kept at 5°C to 30°C or less and 70%RH or less. The LEDs should be soldered within 168 hours (7 days) after opening the package.

Please avoid rapid transitions in ambient temperature in high humidity environments where condensation may occur.

3.Soldering

Do not apply any stress to the lead frame during soldering while the LED is at high temperature.

Recommended soldering condition.

Reflow Soldering:

Pre-heat 120~150°C, 120sec. MAX., Peak temperature : 240°C Max. Soldering time: 10 sec Max.

Soldering Iron: (Not recommended)

Temperature 300°C Max., Soldering time : 3 sec. Max.(one time only), power dissipation of iron : 20W Max. use SN60 solder of solder with silver content and don't to touch LED lens when soldering.

DRAWING NO.: DS-31-09-XXXX

DATE:
PAGE

2009-06-30

11 of 13



SURFACE MOUNT DEVICE LED

Part No.: L-C155TBJSCT-5A

REV:A/0

Wave soldering:

Pre-heat 100°C Max, Pre-heat time 60 sec. Max, Solder wave 260°C Max, Soldering time 5 sec. Max. performed consecutively cooling process is required between 1st and 2nd soldering processes.

4. Lead-Free Soldering

For Reflow Soldering:

- 1、Pre-Heat Temp:150-180°C,120sec.Max.
- 2、Soldering Temp: Temperature Of Soldering Pot Over 230°C,40sec.Max.
- 3、Peak Temperature:260°C , 5sec.
- 4、Reflow Repetition:2 Times Max.
- 5、Suggest Solder Paste Formula 93.3 Sn/3.1 Ag/3.1 Bi /0.5 Cu

For Soldering Iron (Not Recommended):

- 1、Iron Tip Temp:350°C Max.
- 2、Soldering Iron:30w Max.
- 3、Soldering Time:3 Sec. Max. One Time.

For Dip Soldering:

- 1、Pre-Heat Temp:150°C Max. 120 Sec. Max.
- 2、Bath Temp:265°C Max.
- 3、Dip Time:5 Sec. Max.

5. Drive Method

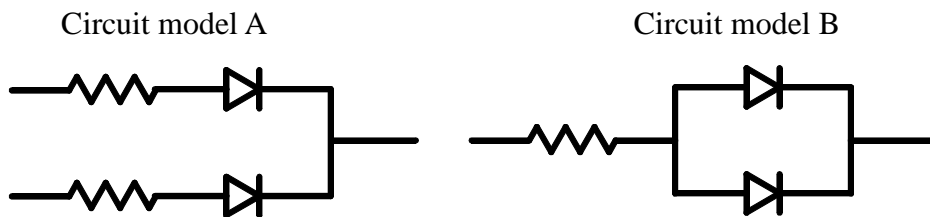

(A)Recommended circuit.

(B)The difference of brightness between LED`s could be found due to the Vf-If characteristics of LED.



SURFACE MOUNT DEVICE LED

Part No.: L-C155TBJST-5A

REV:A/0

6. Reliability Test

Classification	Test Item	Test Condition	Reference Standard
Endurance Test	Operation Life	Ta= Under Room Temperature As Per Data Sheet Maximum Rating *Test Time= 1000HRS (-24HRS,+72HRS)*@20mA.	MIL-STD-750D: 1026 (1995) MIL-STD-883D: 1005 (1991) JIS C 7021:B-1 (1982)
	High Temperature High Humidity Storage	IR-Reflow In-Board, 2 Times Ta= 65±5°C, RH= 90~95% *Test Time= 1000HRS±2HRS	MIL-STD-202F: 103B(1980) JIS C 7021: B-11 (1982)
	High Temperature Storage	Ta= 105±5°C Test Time= 1000HRS (-24HRS, 72HRS)	MIL-STD-883D: 1008 (1991) JIS C 7021:B-10 (1982)
	Low Temperature Storage	Ta= -55±5°C *Test Time=1000HRS (-24HRS, 72H RS)	JIS C 7021:B-12 (1982)
Environmental Test	Temperature Cycling	105±5°C -55±5°C 10mins 10mins 100 Cycles	MIL-STD-202F: 107D (1980) MIL-STD-750D: 1051(1995) MIL-STD-883D: 1010 (1991) JIS C 7021: A-4 (1982)
	Thermal Shock	IR-Reflow In-Board, 2 Times 105±5°C -55°C±5°C 10mins 10mins 100 Cycles	MIL-STD-202F: 107D(1980) MIL-STD-750D: 1051(1995) MIL-STD-883D: 1011(1991)
	Solder Resistance	Tsol= 260 ± 5°C Dwell Time= 10 ± 1sec	MIL-STD-202F: 210A(1980) MIL-STD-750D: 2031(1995) JIS C 7021: A-1 (1982)
	Solder ability	Tsol= 235 ± 5°C Immersion time 2±0.5 sec Immersion rate 25±2.5 mm/sec Coverage ≥95% of the dipped surface	MIL-STD-202F: 208D(1980) MIL-STD-750D: 2026(1995) MIL-STD-883D: 2003(1991) IEC 68 Part 2-20 JIS C 7021: A-2 (1982)

7. Others:

The appearance and specifications of the product may be modified for improvement without notice.