

TRANSISTOR(PNP)

FEATURES

- High Collector Current
- Complementary to SS8050

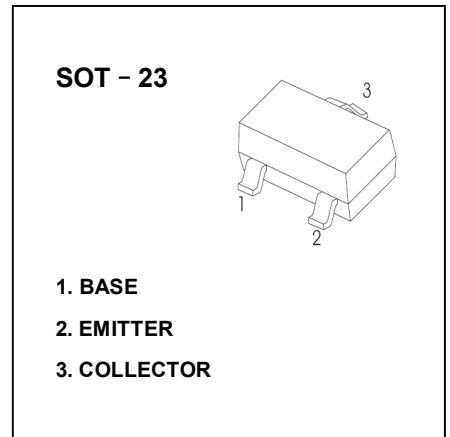

MAXIMUM RATINGS ($T_a=25^{\circ}\text{C}$ unless otherwise noted)

Symbol	Parameter	Value	Unit
V_{CBO}	Collector-Base Voltage	-40	V
V_{CEO}	Collector-Emitter Voltage	-25	V
V_{EBO}	Emitter-Base Voltage	-5	V
I_C	Collector Current	-1.5	A
P_C	Collector Power Dissipation	300	mW
$R_{\theta JA}$	Thermal Resistance From Junction To Ambient	417	$^{\circ}\text{C}/\text{W}$
T_j	Junction Temperature	150	$^{\circ}\text{C}$
T_{stg}	Storage Temperature	-55~+150	$^{\circ}\text{C}$

ELECTRICAL CHARACTERISTICS ($T_a=25^{\circ}\text{C}$ unless otherwise specified)

Parameter	Symbol	Test conditions	Min	Typ	Max	Unit
Collector-base breakdown voltage	$V_{(BR)CBO}$	$I_C=-100\mu\text{A}, I_E=0$	-40			V
Collector-emitter breakdown voltage	$V_{(BR)CEO}$	$I_C=-0.1\text{mA}, I_B=0$	-25			V
Emitter-base breakdown voltage	$V_{(BR)EBO}$	$I_E=-100\mu\text{A}, I_C=0$	-5			V
Collector cut-off current	I_{CBO}	$V_{CB}=-40\text{V}, I_E=0$			-100	nA
Collector cut-off current	I_{CEO}	$V_{CE}=-20\text{V}, I_B=0$			-100	nA
Emitter cut-off current	I_{EBO}	$V_{EB}=-5\text{V}, I_C=0$			-100	nA
DC current gain	$h_{FE(1)}$	$V_{CE}=-1\text{V}, I_C=-100\text{mA}$	120		400	
	$h_{FE(2)}$	$V_{CE}=-1\text{V}, I_C=-800\text{mA}$	40			
Collector-emitter saturation voltage	$V_{CE(sat)}$	$I_C=-800\text{mA}, I_B=-80\text{mA}$			-0.5	V
Base-emitter saturation voltage	$V_{BE(sat)}$	$I_C=-800\text{mA}, I_B=-80\text{mA}$			-1.2	V
Base-emitter voltage	V_{BE}	$V_{CE}=-1\text{V}, I_C=-10\text{mA}$			-1	V
Transition frequency	f_T	$V_{CE}=-10\text{V}, I_C=-50\text{mA}, f=30\text{MHz}$	100			MHz
Collector output capacitance	C_{ob}	$V_{CB}=-10\text{V}, I_E=0, f=1\text{MHz}$			20	pF

CLASSIFICATION OF $h_{FE(1)}$

RANK	L	H	J
RANGE	120 - 200	200 - 350	300 - 400

Static Characteristic

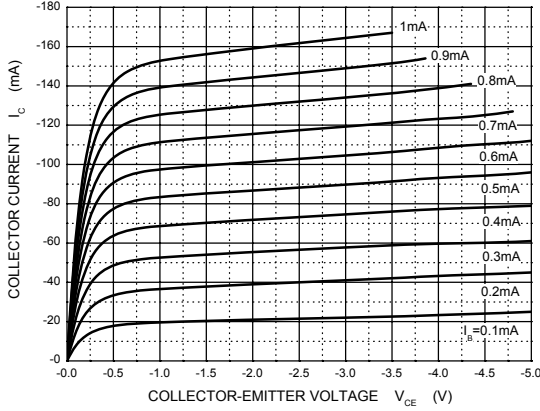

$h_{FE} - I_c$

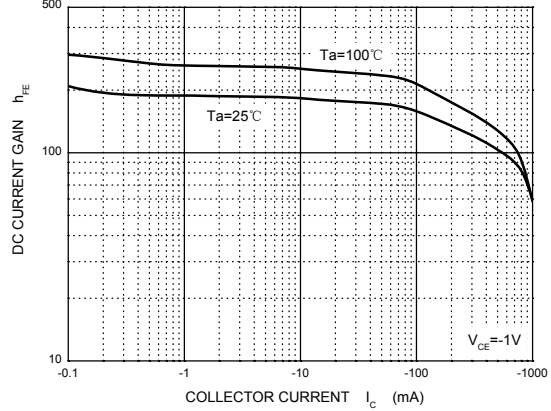

$V_{BEsat} - I_c$

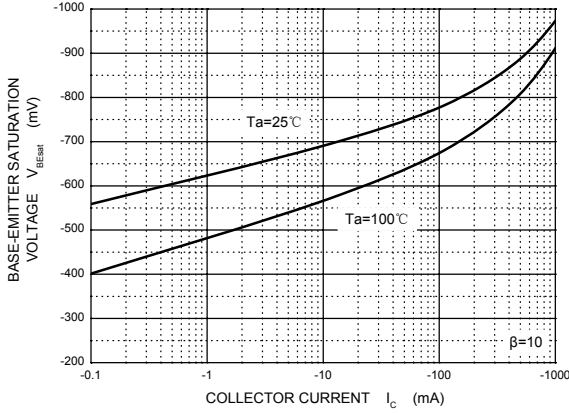

$V_{CEsat} - I_c$

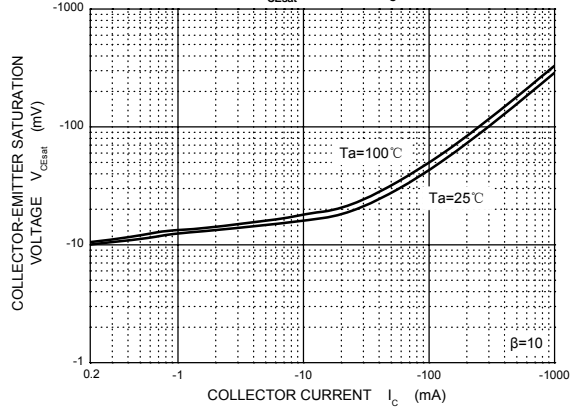

$V_{BE} - I_c$

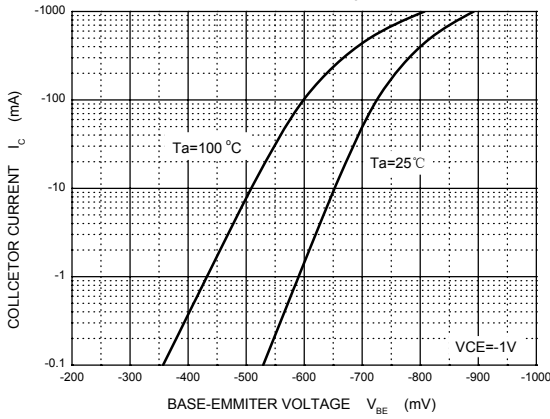

$C_{ob}/C_{ib} - V_{CB}/V_{EB}$

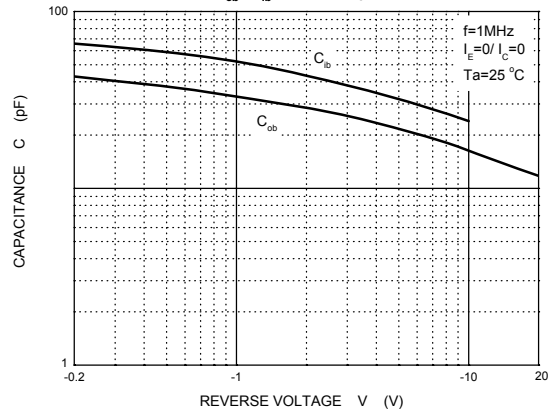

$f_T - I_c$

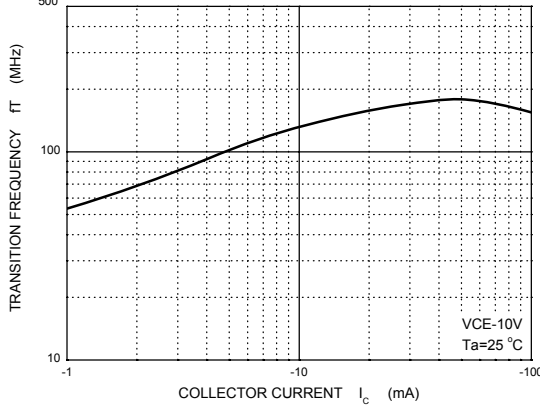

$P_c - T_a$

