

## 1625 nm DFB LASER DIODE MODULES

## DL-5500S-1625 Series

2.5 Gbps UNCOOLED MQW DFB LD WITH RECEPTACLE

### FEATURES

- 2 1625 nm Uncooled Laser Diode with MQW Structure
- 2 High Reliability, Long Operation Life
- 2 Single Frequency Operation with High SMSR
- 2 0 to 70°C operation without active cooling
- 2 Build-in InGaAs monitor
- 2 Speed upto 2.5 Gbps

### APPLICATION

Trunk Line, FitL

### DESCRIPTION

DL-5500S-1625 series are designed for coupling a single mode optical fiber with 1625 nm MQW DFB uncooled laser diode. DL-5500S-1625 series are the best kits as light sources for telecom and datacom applications.

ELECTRICAL AND OPTICAL CHARACTERISTICS (T <sub>C</sub> =25 °C)						
Symbol	Parameter	Test Conditions	Min.	Typ.	Max.	Unit
I <sub>th</sub>	Threshold Current	CW		10	15	mA
V <sub>OP</sub>	Operating Voltage	CW, I <sub>F</sub> =I <sub>th</sub> +25mA		1.2	1.5	V
P <sub>f</sub>	Optical Output Power Part No:DL-552XS-1625 DL-553XS-1625	CW, I <sub>F</sub> =I <sub>th</sub> +25mA	1.0 2.0	- -	- -	mW
λ <sub>c</sub>	Center Wavelength	CW, I <sub>th</sub> +25mA	1620	1625	1630	nm
SMSR	Side Mode Suppression Ratio	CW, I <sub>th</sub> +25mA	30	35		dB
t <sub>r</sub> , t <sub>f</sub>	Rise And Fall Times	I <sub>F</sub> =I <sub>th</sub> , I <sub>th</sub> +25mA, 20~80%			0.226	ns
ΔP <sub>f</sub> /P <sub>f</sub>	Tracking Error	APC, 0~+70 °C	-	-	±1.5	dB
I <sub>m</sub>	PD Monitor Current	CW, I <sub>th</sub> +25mA, V <sub>RD</sub> =1V	100			μA
I <sub>D</sub>	PD Dark Current	V <sub>RD</sub> =5V			0.1	μA
C <sub>t</sub>	PD Capacitance	V <sub>RD</sub> =5V, f=1MHz		10	15	pF

ABSOLUTE MAXIMUM RATINGS (T <sub>C</sub> =25 °C)			
Symbol	Parameter	Ratings	Unit
P <sub>o</sub>	Optical Output Power (552XS/553XS)	1.5 / 3	mW
V <sub>RL</sub>	LD Reverse Voltage	2	V
V <sub>RD</sub>	PD Reverse Voltage	10	V
I <sub>FD</sub>	PD Forward Current	1.0	mA
T <sub>opr</sub>	Operating Temperature	0 to 70	°C
T <sub>stg</sub>	Storage Temperature	-40~+85	°C

MECHANICAL DIMENSION (mm) and PIN ASSIGNMENT

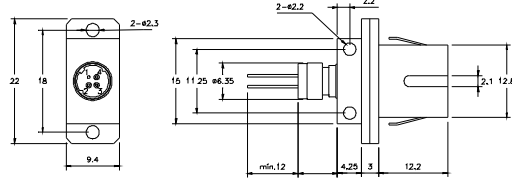
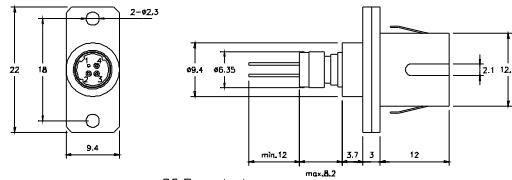
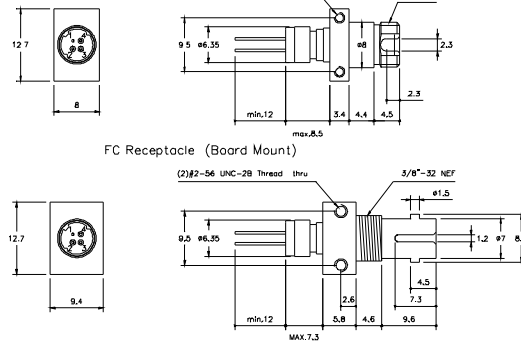
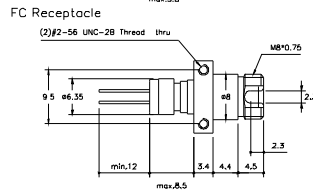
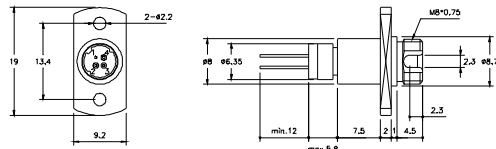
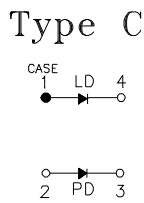
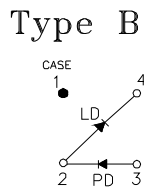
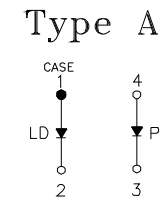

**Note:** Specifications subject to change without notice.

ORDER INFORMATION

