

**Linear Hall Effect Sensor IC**

**Features:**

- Wide operating range 3.0~12V, -40°C~125°C
- Flat Response to 23kHz
- High Sensitivity 1.5 mV/Gauss
- Wide output voltage range 0.2~4.8V (at V<sub>dd</sub>=5V)
- Low temperature drift  $\pm 0.2$  mV/°C
- Wide sensible magnetic field range on different supplied voltage  
±1,500 Gauss on 5V supplied voltage  
±3,000 Gauss on 12V supplied voltage. Low operating current 3mA
- Two package styles TO-92S/SOT-23 available.

**Functional Description :**

The WSH315 is a new version of WSH135 with better measuring range and thermal shift. It integrates Hall sensing element, linear amplifier, sensitivity controller and emitter follower output stage. It accurately tracks extremely small change in magnetic flux density –generally too small to operate Hall effect switch.

W315 can be applied as current sensor, tooth sensor, proximity detectors and motion detectors. As sensitive monitor of magnetic flux, it can effectively measure a system's performance with negligible system loading while providing isolation from contaminated and electrically noisy environments.

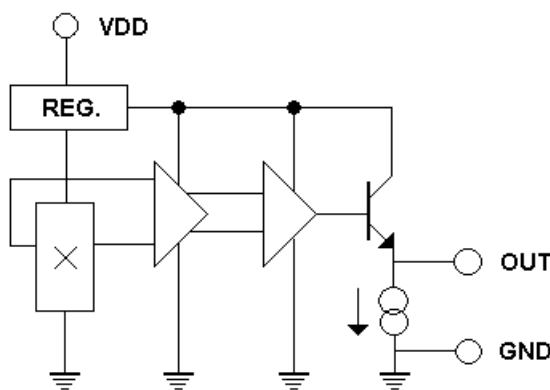
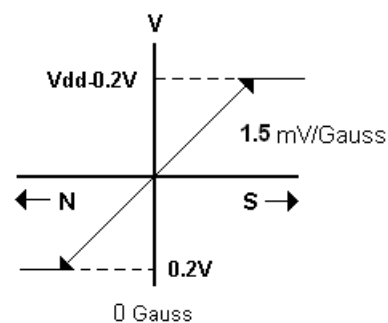
**OUT vs. Magnetic Flux**

Winson reserves the right to make changes to improve reliability or manufacturability.

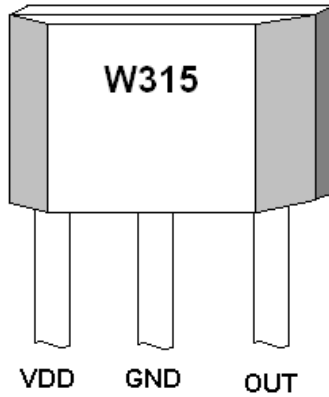

### ABSOLUTE MAXIMUM RATING

Supply Voltage, Vdd	14V
Magnetic Flux Density, B	Unlimited
Output Driving Current	0.4mA
Operating Temperature Range	
Ta	-40°C to +125°C
Storage Temperature Range	
Ts	-65°C to +150°C
Power Dissipation Pd	
TO-92S	450mW
SOT-23	350mW

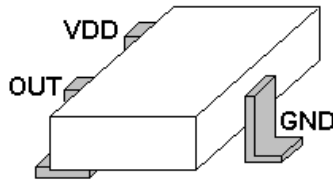

### ORDER INFORMATION

WSH315-XPAN □ (TO-92S)	1: A Grade 2: B Grade
WSH315-PCN □ (SOT-23)	
↑ Grade	

ps: (TO-92S) — 1,000/bag, (SOT-23) — 3,000/reel

### Electrical Characteristics:

(T=+25°C, Vdd=5.0V)

Characteristic	Symbol	Test Conditions	Min	Typ	Max	Units
Supply Voltage	Vcc	—	3.0	—	12	V
Supply Current	I <sub>supply</sub>	B=0 Gauss	—	3.0	5.0	mA
Quiescent Vout	V <sub>OG</sub>	B=0 G (Grade A)	2.45	2.5	2.55	V
		B=0 G (Grade B)	2.35	2.5	2.65	V
Sensitivity	ΔV <sub>out</sub>	B= 0 to ± 500 G	1.2	1.5	1.8	mV/G
Bandwidth	BW		—	23	—	kHz
Measurable Gauss Range	MGR	Vdd=5V	—	±1500	—	Guass
		Vdd=12V	—	±3000	—	
Temperature Drift	ΔV <sub>out</sub>	B=0 Gauss	—	±0.2	—	mV/°C

1. All output-voltage measurements are made with a voltmeter having an input impedance of at least 100kΩ

2. Do not apply any load on output pin, it will degrade IC performance.

Winson reserves the right to make changes to improve reliability or manufacturability.

Package Information:

**TO92S:**

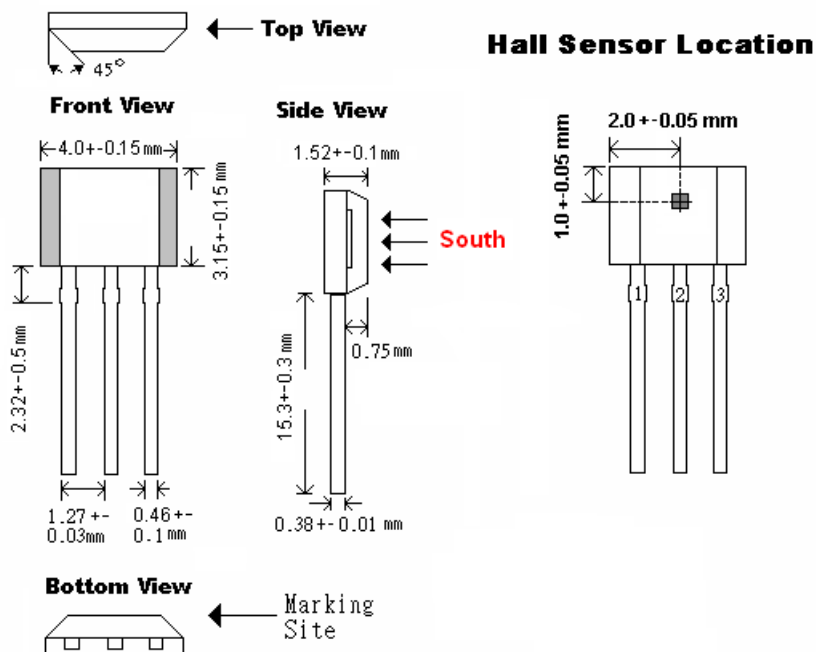

**SOT23:**

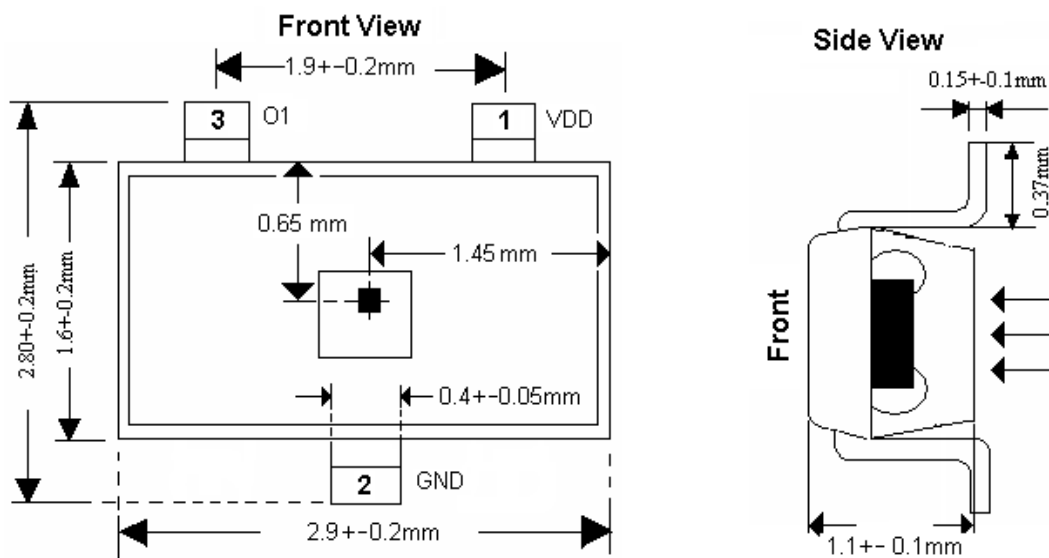

Winson reserves the right to make changes to improve reliability or manufacturability.

## Electrical Characteristic Diagram:

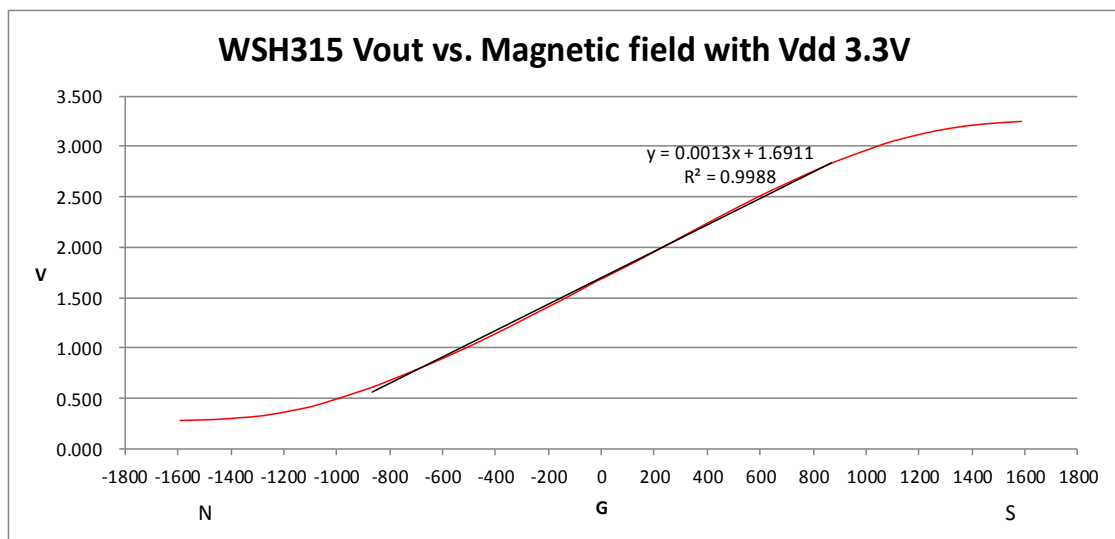
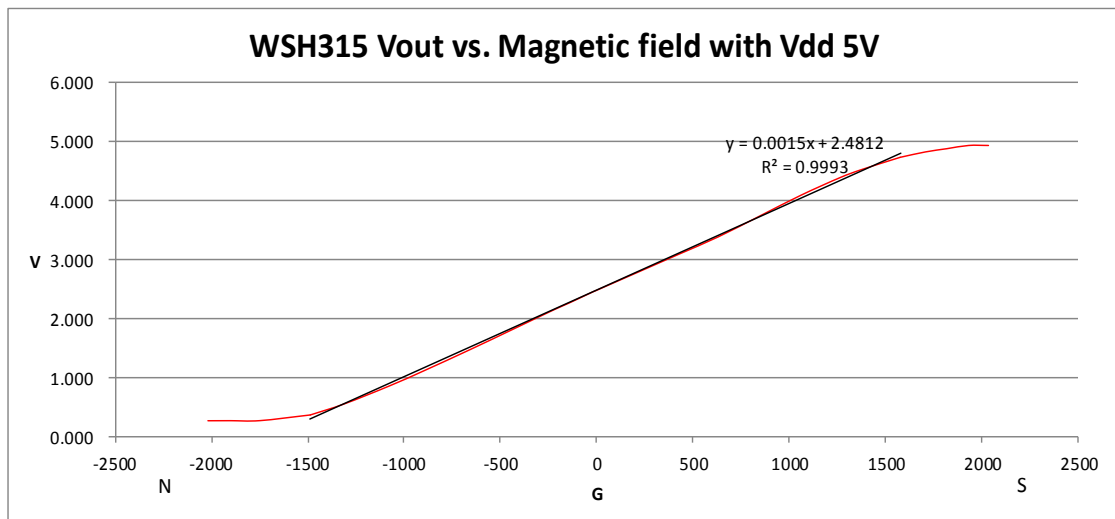
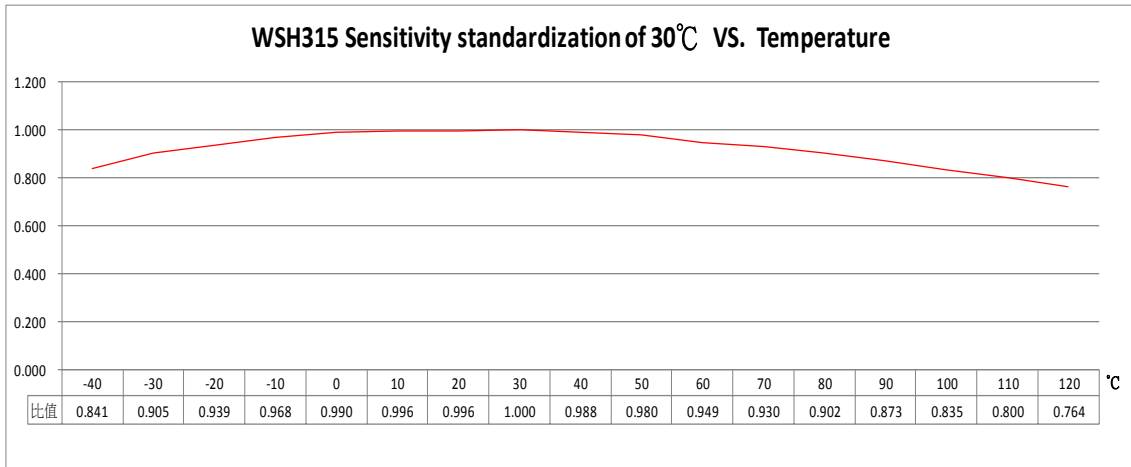

Winson reserves the right to make changes to improve reliability or manufacturability.

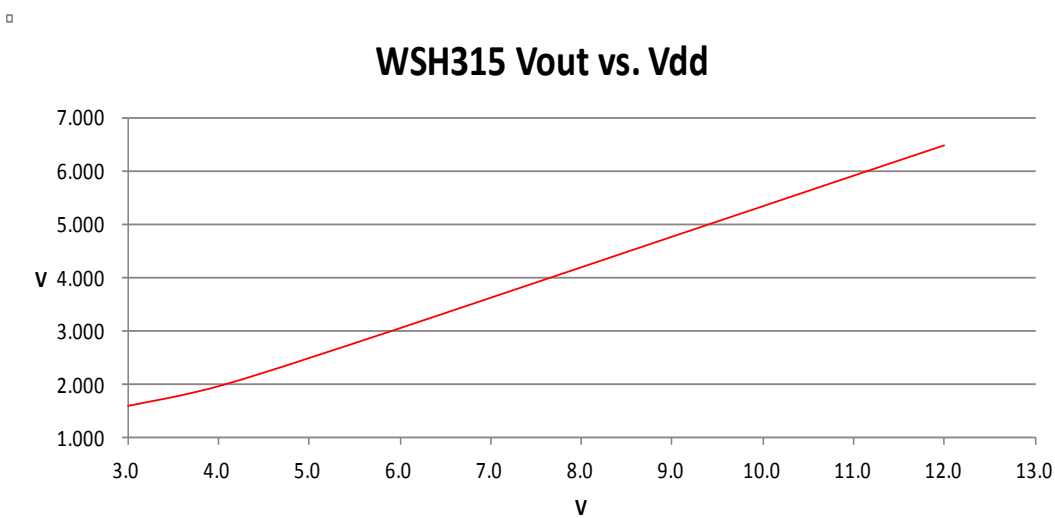
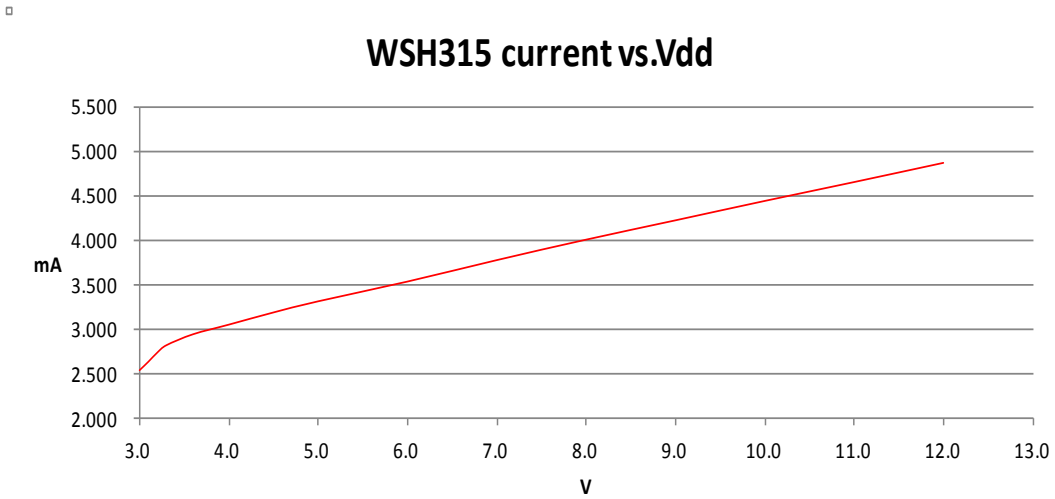
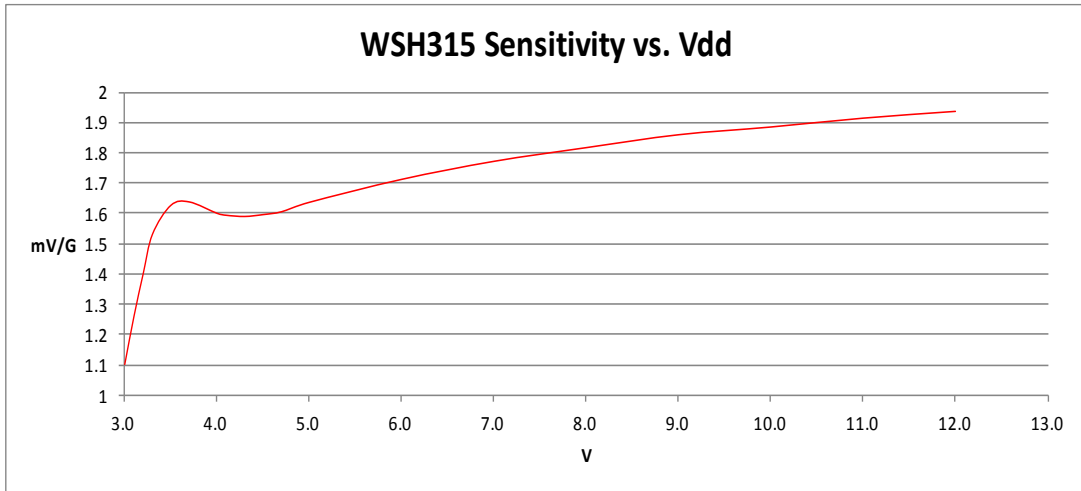

Winson reserves the right to make changes to improve reliability or manufacturability.