



Front: QCLs
Back: Set-up examples with exclusive accessories

Quantum Cascade Laser

Quantum Cascade Lasers are semiconductor lasers that offer peak emission in the mid-IR range (4 μm to 10 μm). They have gained considerable attention as a new light source for mid-IR applications such as molecular gas analysis.

- **Features**
 - Mid-IR laser (4 μm to 10 μm)
 - Compact, lightweight
- **Applications**
 - Trace gas analysis Environmental measurement, Combustion gas measurement, Plasma measurement, In vivo gas analysis
 - IR molecular spectroscopy Chemical sensing, Molecular oscillation

QCL LINEUP

DFB-CW Type

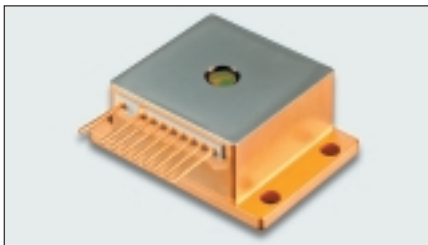

HHL package

Quantum Cascade Lasers, using structures of SPC (Single Phonon-Continuum) depopulation and DFB (Distributed Feedback), emit CW (Continuous Wave) mid-IR laser under room temperature.

By controlling the chip's operating temperature through the Peltier element installed in the HHL package, it is possible to tune the emission wavelength without mode hopping while keeping longitudinal single mode operation.

Type No.	Wavelength Typ.	Operating temperature (QCL) ^{(*)1}		Line width ^{(*)2}	Tunable range ^{(*)3}	Output power	Threshold current	Side-mode suppression ratio (SMSR)	
		Min.	Max.	Max.	Min.	Min.	Max.	Min.	
L12004-2209H-C	4.53 μm	+10 °C	+50 °C	0.2 cm ⁻¹ ^{(*)4}	±1.0 cm ⁻¹	20 mW	1.0 A	25 dB	
		Condition: K=2209 cm ⁻¹ ^{(*)5}						Condition: T _{op(qcl)} =20 °C	
L12004-2190H-C	4.57 μm	+10 °C	+50 °C	0.2 cm ⁻¹ ^{(*)4}	±1.0 cm ⁻¹	20 mW	1.0 A	25 dB	
		Condition: K=2190 cm ⁻¹ ^{(*)5}						Condition: T _{op(qcl)} =20 °C	
L12005-1900H-C	5.26 μm	+10 °C	+50 °C	0.2 cm ⁻¹ ^{(*)4}	±1.0 cm ⁻¹	20 mW	1.0 A	25 dB	
		Condition: K=1900 cm ⁻¹ ^{(*)5}						Condition: T _{op(qcl)} =20 °C	
L12006-1631H-C	6.13 μm	+10 °C	+50 °C	0.2 cm ⁻¹ ^{(*)4}	±1.0 cm ⁻¹	20 mW	1.0 A	25 dB	
		Condition: K=1631 cm ⁻¹ ^{(*)5}						Condition: T _{op(qcl)} =20 °C	
L12007-1294H-C	7.73 μm	+10 °C	+50 °C	0.2 cm ⁻¹ ^{(*)4}	±1.0 cm ⁻¹	20 mW	1.0 A	25 dB	
		Condition: K=1294 cm ⁻¹ ^{(*)5}						Condition: T _{op(qcl)} =20 °C	

(*)1 This specifies the temperature range within which the target emission wavenumber (K) can be realized. (*)2 Full-width half maximum
 (*)3 This specifies the continuous tunable range (without mode hopping). The center wavenumber of the tuning range is the emission wavenumber (K).
 (*)4 The figures are limited by the resolution and signal/noise ratio of the measuring instruments used. (*)5 K: Emission wavenumber (cm⁻¹)

■ Limited quantities of QCLs with emission wavelengths close to those specified above may be available occasionally. Please contact a Hamamatsu sales office for information on available stock.

Characteristics examples

●L12004-2209H-C

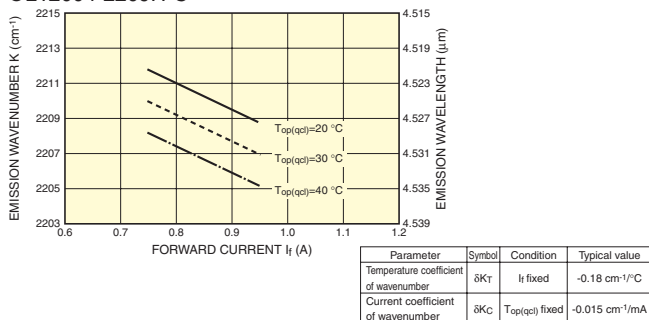

●L12004-2190H-C

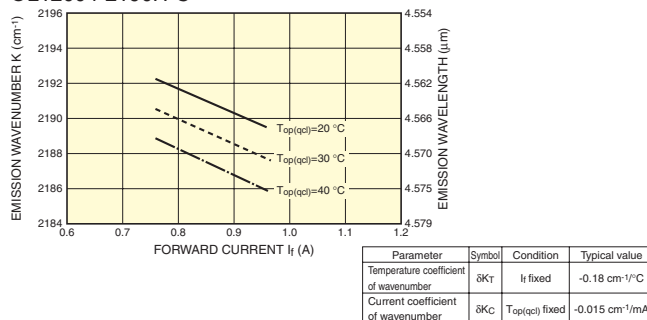

●L12005-1900H-C

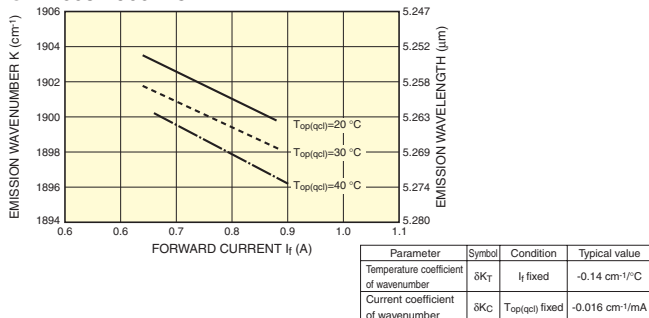

●L12006-1631H-C

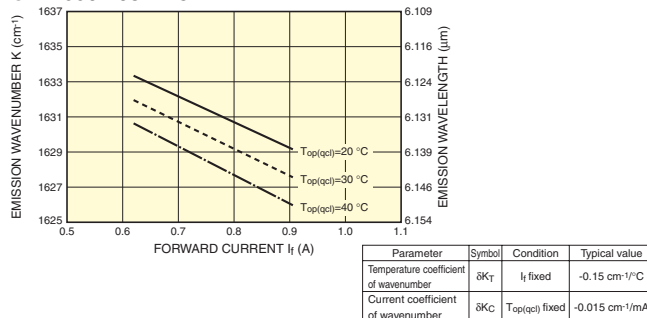

●L12007-1294H-C

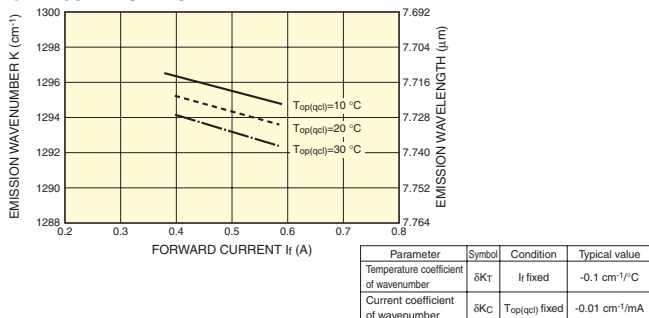

CLASS 3B LASER
Invisible Laser Radiation: Avoid Exposure to Beam

●The Laser emits invisible laser radiation. The instrument which used the LASER, operated under ordinary conditions, is classified as Class 3B according to the laser product classification code IEC 60825-1. See IEC 60825-1, -14 for more details and safety operation concerning the above countermeasures.

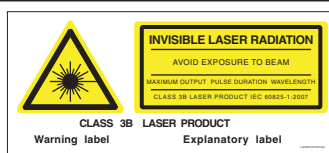

DFB-Pulsed Type

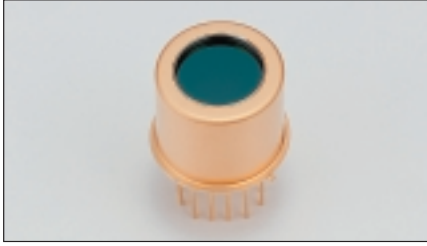

TO-8 package

Quantum Cascade Lasers, using structures of SPC (Single Phonon-Continuum) depopulation and DFB (Distributed Feedback), emit pulsed mid-IR laser under room temperature.

By controlling the chip's operating temperature through the Peltier element installed in the TO-8 package, it is possible to tune the emission wavelength without mode hopping while keeping longitudinal single mode operation.

Type No.	Wavelength	Operating temperature (QCL) ^(*)		Line width ⁽²⁾	Tunable range ⁽³⁾	Pulsed output power	Threshold current	Side-mode suppression ratio (SMSR)	
	Typ.	Min.	Max.	Max.	Min.	Min.	Max.	Min.	
L12014-2231T-C	4.48 μm	-10 °C	+50 °C	0.2 cm ⁻¹ ⁽⁴⁾	±1.0 cm ⁻¹	50 mW	1.5 A	25 dB	
		Condition: K=2231 cm ⁻¹ ⁽⁵⁾							
L12015-1901T-C	5.26 μm	-10 °C	+50 °C	0.2 cm ⁻¹ ⁽⁴⁾	±1.0 cm ⁻¹	50 mW	1.5 A	25 dB	
		Condition: K=1901 cm ⁻¹ ⁽⁵⁾							
L12016-1630T-C	6.13 μm	-10 °C	+50 °C	0.2 cm ⁻¹ ⁽⁴⁾	±1.0 cm ⁻¹	50 mW	1.5 A	25 dB	
		Condition: K=1630 cm ⁻¹ ⁽⁵⁾							
L12017-1278T-C	7.82 μm	-10 °C	+50 °C	0.2 cm ⁻¹ ⁽⁴⁾	±1.0 cm ⁻¹	50 mW	1.5 A	25 dB	
		Condition: K=1278 cm ⁻¹ ⁽⁵⁾							

Standard driving conditions: $t_w=10$ ns, $f_r=200$ kHz, $T_{op(qcl)}=20$ °C

(*) This specifies the temperature range within which the target emission wavenumber (K) can be realized. (2) Full-width half maximum

(3) This specifies the continuous tunable range (without mode hopping). The center wavenumber of the tuning range is the emission wavenumber (K).

(4) The figures are limited by the resolution and signal/noise ratio of the measuring instruments used. (5) K: Emission wavenumber (cm⁻¹)

Characteristics examples

● L12014-2231T-C

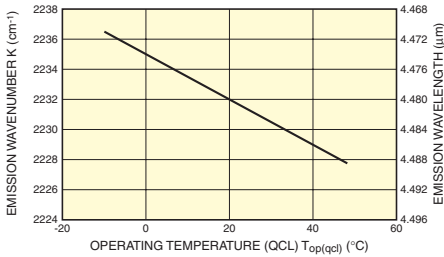

Parameter	Symbol	Condition	Typical value
Temperature coefficient of wavenumber	δK_T	I_p fixed	-0.15 cm ⁻¹ /°C

● L12015-1901T-C

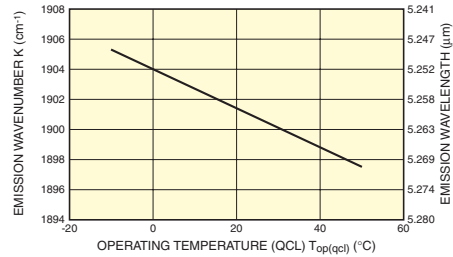

Parameter	Symbol	Condition	Typical value
Temperature coefficient of wavenumber	δK_T	I_p fixed	-0.13 cm ⁻¹ /°C

● L12016-1630T-C

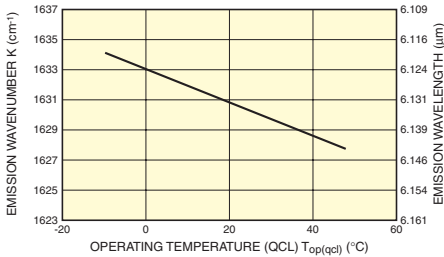

Parameter	Symbol	Condition	Typical value
Temperature coefficient of wavenumber	δK_T	I_p fixed	-0.11 cm ⁻¹ /°C

● L12017-1278T-C

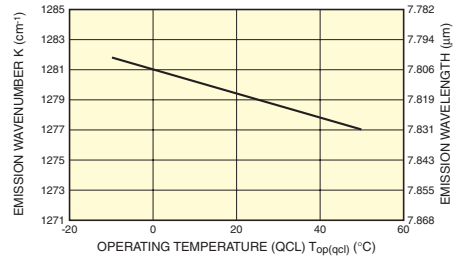

Parameter	Symbol	Condition	Typical value
Temperature coefficient of wavenumber	δK_T	I_p fixed	-0.08 cm ⁻¹ /°C

CLASS 3R LASER

Invisible Laser Radiation: Avoid Direct Exposure of eyes to Beam

● The Laser emits invisible laser radiation. The instrument which used the LASER, operated under ordinary conditions, is classified as Class 3R according to the laser product classification code IEC 60825-1. See IEC 60825-1 for more details and safety operation concerning the above countermeasures.

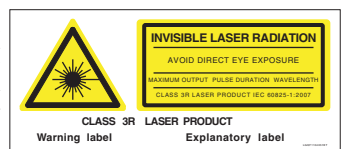

QCL LINEUP

DFB-CW Type

Dimensional outline (unit: mm)

HHL package

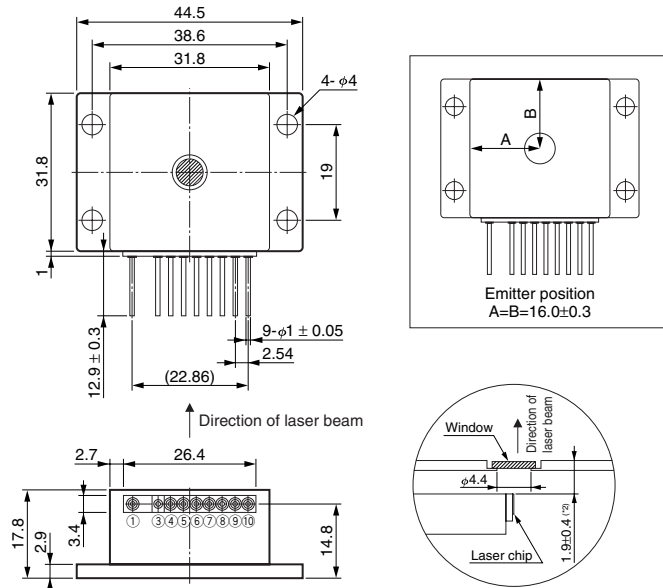

(*1) Tolerance is +/- 0.2 mm unless specified.
(*2) Edge of QCL chip and outside of the package

PIN No. (*3)	FUNCTION	PIN No. (*3)	FUNCTION
①	TEC Cathode (-)	⑦	QCL Cathode (-)
②	N.C.	⑧	Thermistor (Top(c))
③	QCL Anode (+)	⑨	Thermistor (Top(qcl))
④	Thermistor (Top(qcl))	⑩	TEC Anode (+)
⑤	Thermistor (Top(qcl))	—	—
⑥	Thermistor (Top(qcl))	—	—

(*3) ③ is electrically connected to the package. The other pins are electrically isolated from the package.

DFB-Pulsed Type

Dimensional outline (unit: mm)

TO-8 package

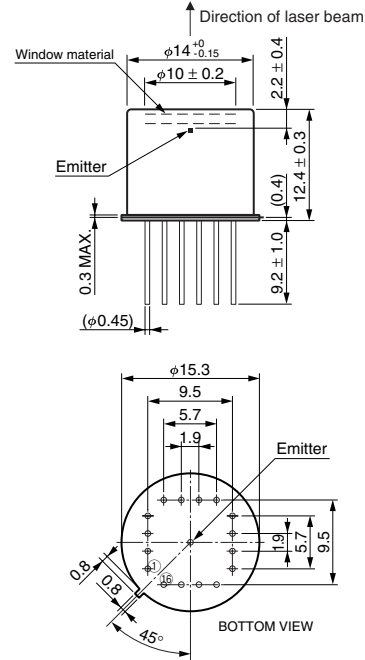

PIN No.	FUNCTION	PIN No.	FUNCTION	PIN No.	FUNCTION
①	TEC Cathode (-)	⑦	QCL Anode (+)	⑬	QCL Cathode (-)
②	N.C.	⑧	QCL Anode (+)	⑭	QCL Cathode (-)
③	N.C.	⑨	Thermistor (Top(qcl))	⑮	QCL Cathode (-)
④	TEC Anode (+)	⑩	Thermistor (Top(qcl))	⑯	QCL Cathode (-)
⑤	QCL Anode (+)	⑪	N.C.	—	—
⑥	QCL Anode (+)	⑫	N.C.	—	—

* All the pins are electrically isolated from the package.

CONNECTION EXAMPLE

DFB-CW QCL

- ① DFB-CW QCL (L12004, L12005, L12006, L12007 Series)
- ② Peltier TEC Driver C11330-01
- ③ Forced Air Cooling HHL Mount A11709-01 or Water Cooling HHL Mount A11709-02
- ④ Aspheric ZnSe lens A11331-0x and/or Lens unit A11331-0xH
(Select a suitable Aspheric ZnSe Lens in accordance with the QCL's emission wavelength.)
- ⑤ Cable A11134-04
- ⑥ Laser Power Supply

DFB-Pulsed QCL

- ① DFB-Pulsed QCL (L12014, L12015, L12016, L12017 series)
- ② Peltier TEC Driver C11330-02
- ③ Pulsed QCL Driver Module C11635
- ④ Aspheric ZnSe lens A11331-0x and/or Lens unit A11331-0xH
(Select a suitable Aspheric ZnSe Lens in accordance with the QCL's emission wavelength.)
- ⑤ Cable A11134-04

PERIPHERAL INSTRUMENTS AND ACCESSORIES

HHL Mount A1709 Series



A11709-01 Forced air cooling

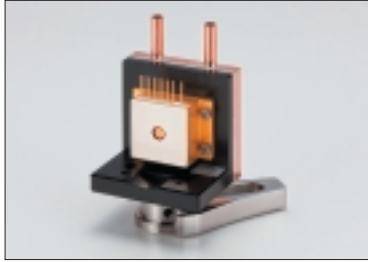

A11709-02 Water cooling

* Mounts shown in photos have HHL package QCL.

Cooling Unit for HHL packaged QCL. Two types of cooling, forced air and water, are available. An Aspheric ZnSe Lens Unit A11331-0xH can be mounted.

Parameter	A11709-01	A11709-02	Unit
Cooling method	Forced air cooling	Water cooling	—
Maximum heat discharge power	Approx. 30 ^(*)	Approx. 50 ^(*)	W
Thermal resistance	Approx. 0.5 ^(*)	Approx. 0.3 ^(*)	°C/W
Applicable package	HHL		—
Operating temperature	0 to +40		°C
Size (W × H × D)	68 × 82 × 117	60 × 103 × 50	mm
Weight	0.5	0.52	kg

(*) DC fan speed 7600 min⁻¹ at ambient temperature 25 °C

(*) Necessary flow rate and water temperature: 2000 cc/min. at 20 °C

- Features**
- Two types of cooling (water, forced air) are available.
 - Easy to mount
 - Easily set on optical tables
 - Can be mounted to the lens unit A11331-0xH

TO-8 Pulse Driver C11635



* Driver shown in photo has a TO-8 package QCL.

Pulsed QCL Driver for TO-8 packaged pulsed QCL. It outputs low noise pulsed current, and TO-8 packaged pulsed QCL can be mounted directly. An Aspheric ZnSe Lens Unit A11331-0xH can be mounted.

Parameter	Symbol	Value	Unit
Output current	Output current range	$I_{(pulse)}$	0 to 3
	Pulse width (Typ.)	P_w	10
	Rise / fall time (Typ.)	T_r	5
	Repetition frequency	—	Approx. 150 kHz to Approx. 1 MHz
	Duty ratio	DR	<5
Dimensions (W × H × D)	—	90 × 68 × 43	mm
Weight	—	0.3	kg

* can be mounted to aspheric lens unit A11331-0xH.

* repetition frequency up to 2 MHz

* pulse width down to 40 ns (repetition frequency < 500 kHz)

* pulse width up to 1000 ns (repetition frequency < 100 kHz)

* external trigger operation by removing the oscillating board

* Two types of DC power supplies and a TEC driver are separately needed

* An oscilloscope is separately needed for observation of current output shape.

* Bias source or TTL gate source should be separately prepared at the needs of usage.

Setup example

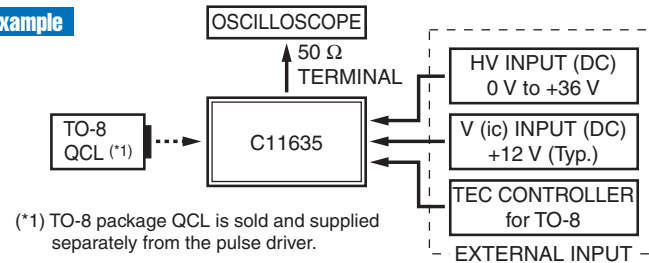

(*1) TO-8 package QCL is sold and supplied separately from the pulse driver.

- Features**
- Can be connected to TO-8 package QCL
 - Pulse width: 10 ns (Typ.)
 - Repetition frequency: <1 MHz
 - Low noise, high stability
 - Designed to be built into an instrument

TEC Driver C11330 Series



Peltier TEC (thermoelectric cooler) driver is used to control QCL temperature with high accuracy and high stability. Designed to be built into an instrument.

Parameter	C11330-01	C11330-02	Unit
Applicable package	HHL	TO-8	—
TEC output ^(*)	TEC control current	-8 to +8	A
	Compliance voltage	±24	
Temperature sensor ^(*)	Thermistor	NTC, 2 lines	
	RTD sensor	3-line platinum temperature measurement resistance (Pt100)	
Temperature control	Temperature control range (Thermistor/RTD)	-50 to +125 / -50 to +150	
	Setup resolution	0.01	
	Temperature stability	±0.01 (Typ.)	
	Control frequency	0.1 to 100	
	Control algorithm	Digital PID loop ^(*)	
Host interface	RS-232C, RS-422		—
Main body size (W × H × D)	100 × 110 × 33		mm
Weight	0.3		kg

(*1) Actual output depends on characteristics of the connected load (TEL module), input power supply voltage, and current.

(*2) Thermistor and Pt100 cannot be used simultaneously; select one of them.

(*3) Auto-tuning function can be set by the host interface.

* This can be controlled from a PC through RS-232C or RS-422.

* A power supply (DC 24V), power cable, output cable, communication cable, terminal for control are separately needed.

* When controlling through a PC which does not have any ports or terminal emulators for serial communication, use an USB serial converter of HPK's recommendation (Windows7 or later).

- Features**
- High accuracy, high stability
 - Temperature stability: 0.01 °C
 - TEC heatsink monitoring function
 - Bipolar output, digital PID control

PERIPHERAL INSTRUMENTS AND ACCESSORIES

Cables

●HHL Socket Cable A11134-01

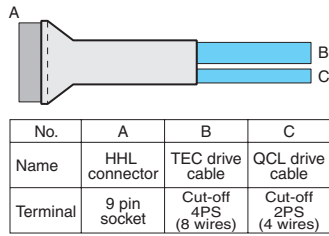

Terminals B and C are to be modified in accordance with the type of TEC and power supply.

Pin layout

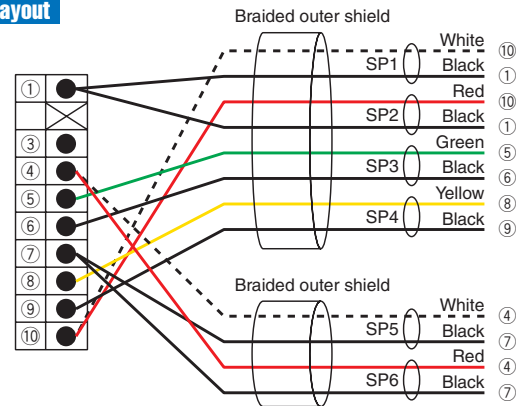

●Signal Cable for C11330 A11134-04



Dimensional outline (unit: mm)

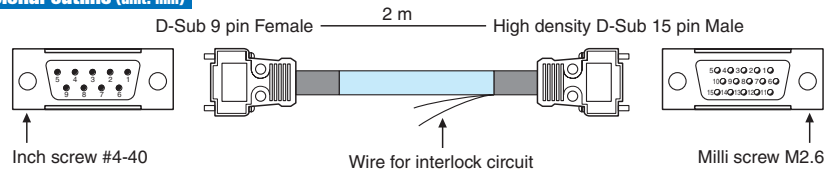

PC Side
D-Sub 9 pin layout

Pin No.	Signal
1	DCD
2	RxD
3	TxD
4	DTR
5	GND
6	DSR
7	RTS
8	CTS
9	RI

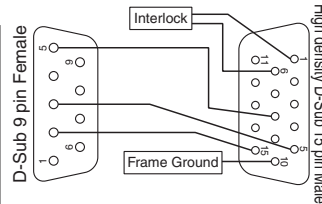

C11330 Side
High density D-Sub 15 pin layout

Pin No.	Signal	Pin No.	Signal
1	INTERLOCK	9	GND
2	ALARM	10	Frame Ground
3	RS-422 Rx+	11	START
4	RS-422 Tx+	12	STABLE
5	RS-232C Rx	13	RS-422 Rx-
6	GND	14	RS-422 Tx-
7	GND	15	RS-232C Tx
8	GND		

Heatseeker A10767

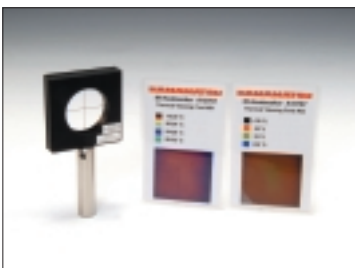

Heatseeker A10767 consists of 2 types of thermal viewing card and an alignment target. It can be used for visualization and alignment of the QCL laser beam.

Thermal Viewing Card

Thermal material provides visibility of the IR laser beam. Facilitates tracing of the invisible laser beam. Two cards with different sensitivity ranges are provided.

Alignment Target

The light axis of the invisible IR laser beam can be easily aligned. Includes a cross target for checking the light axis. Thermal viewing card can be inserted.

Parameter	Description / value	Unit
Detectable temperature range	Thermal viewing card #01	18 to 32 °C
	Thermal viewing card #02	30 to 35 °C
Usable wavelength range	1.0 to 20	μm
Power required for visibility (*1)	>3	mW/mm ²
Damage threshold (Max. power density)	20	mW/mm ²
Maximum aperture	φ30	mm
Storage temperature	-5 to +60 (No condensation)	°C
Dimensions (W × H × D)	50 × 100 × φ12	mm

(*1) Average power density

Dimensional outline (unit: mm)

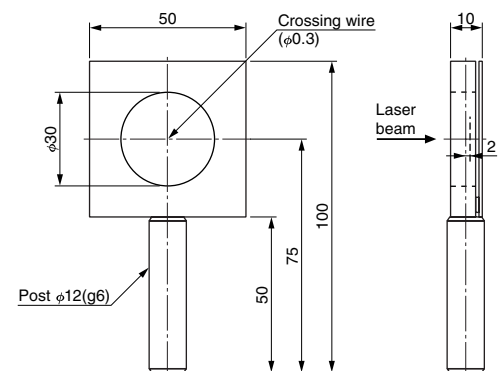

■ Lens / Lens Unit

Aspheric ZnSe Lens for QCL. It can be installed into an Aspheric ZnSe Lens Unit A11331-0xH, and can be mounted onto HHL Mount A11709 series and Pulsed QCL Driver C11635.

● Aspheric ZnSe Lens A11331-0x



* When using the lens by itself, a lens holder is required.

Parameter	Symbol	A11331-01	A11331-02	Unit
Primary design wavelength	λ	8	5	μm
Numerical aperture (NA)	NA	0.78		—
Effective diameter	CA	10		mm
Actual focal distance	EFL	4.8		mm
Working distance	WD	3.0		mm
Periphery	OD	14.9 to 15.0		mm
Center thickness	CT	6.4 ± 0.2	6.3 ± 0.2	mm
Edge thickness	ET	3		mm
Material	—	ZnSe		—
Refractive index	n	2.417 at $8 \mu\text{m}$		—
AR coating	—	BBAR, T (ave)>97 % (*1)	BBAR, T (ave)>96 % (*2)	—
Weight	—	5		g

(*1) T (ave): Average transmittance at wavelength $8 \mu\text{m}$ to $12 \mu\text{m}$

(*2) T (ave): Average transmittance at wavelength $4 \mu\text{m}$ to $8 \mu\text{m}$

Features

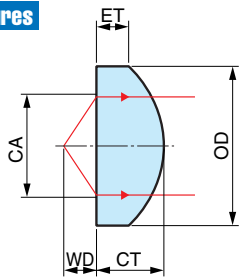

A11331-01
BBAR / $8 \mu\text{m}$ to $12 \mu\text{m}$

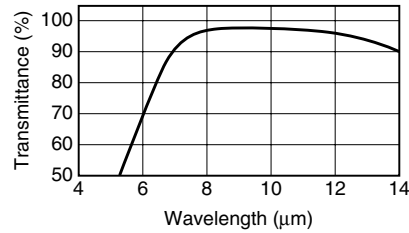

A11331-02
BBAR / $4 \mu\text{m}$ to $8 \mu\text{m}$

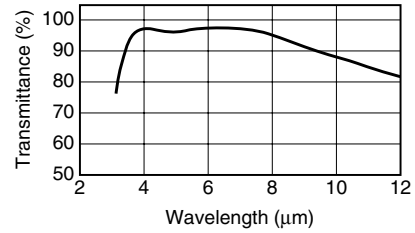

● Aspheric ZnSe Lens Unit A11331-0xH



Parameter		Value
Lens mounting unit	Applicable lens	A11331-01 or A11331-02
XYZ translator	X/Y movable range	$\pm 1 \text{ mm}$

x in the suffix of the part number indicates the type of embedded lens.

Dimensional outline (unit: mm)

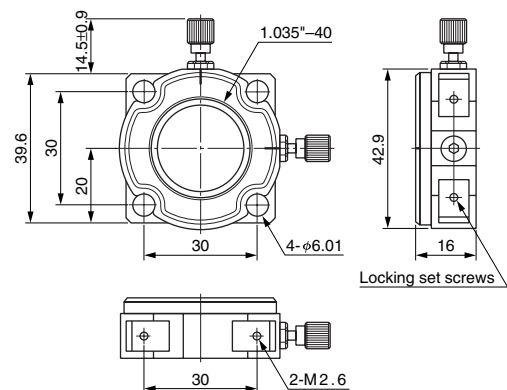
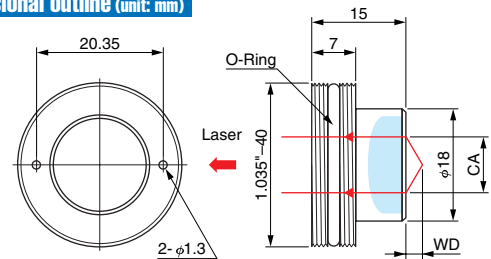

Usage example

A11331-0xH can be mounted on HHL mount A11709 series and pulsed QCL driver C11635.



Mounted on A11709-01



Mounted on A11709-02



Mounted on C11635

Read carefully before using QCL

For safe and effective use of a QCL, carefully read the documents that came with the purchased goods. Also, read carefully to the end of manuals and instructions, and observe the local law regulations about using lasers.

Warning

This catalog is not a guarantee of product perfection. When the products are used in an instrument which may cause bodily harm or damage properties, it is dangerous to operate the instrument unless proper safety measures are taken against possible product defects.

Caution

● Absolute maximum ratings

Absolute maximum ratings listed in the specification sheet and/or test sheet are limiting values that must not be exceeded even momentarily. Using this product under conditions where any one of the maximum ratings is exceeded may cause serious and irreparable damage to the products.

Values in absolute maximum ratings for forward current and forward voltage differ in each product, so always check the values listed in the test sheet that comes with each product and make sure that these values are not exceeded.

● Laser driver power supply

Current surges and current fluctuations may impair performance of the laser device. Do not apply reverse current and reverse voltage to the QCL.

● Heat dissipation

This product uses a Peltier element to control temperature of the laser device, so the Joule heat generated in this product must be dissipated. If operated with poor heat dissipation, the device temperature may soon exceed the absolute maximum rating for the operating case temperature listed in specification sheet. Make sure that a proper heatsink is installed on the product. Poor heat dissipation may lead to excessive heating during operation and cause device deterioration or open-circuit faults even if the Peltier current is within the maximum rating. Heat dissipation on the laser side may not be sufficient when supplying electrical current to the Peltier element in heating mode, and cause failures or affect reliability. Carefully check these points before actual operation.

HAMAMATSU PHOTONICS K.K. www.hamamatsu.com

HAMAMATSU PHOTONICS K.K., Laser Group, Sales Dept.

1-8-3, Shinmiyakoda, Kita-ku, Hamamatsu City, Shizuoka, 431-2103, Japan, Telephone: (81)53-484-1301, Fax: (81)53-484-1302, E-mail: laser-g@lsr.hpk.co.jp

U.S.A.: Hamamatsu Corporation: 360 Foothill Road, P. O. Box 6910, Bridgewater, N.J. 08807-0910, U.S.A., Telephone: (1)908-231-0960, Fax: (1)908-231-1218 E-mail: usa@hamamatsu.com

Germany: Hamamatsu Photonics Deutschland GmbH: Arzbergerstr. 10, D-82211 Herrsching am Ammersee, Germany, Telephone: (49)8152-375-0, Fax: (49)8152-2658 E-mail: info@hamamatsu.de

France: Hamamatsu Photonics France S.A.R.L.: 19, Rue du Saule Trapu, Parc du Moulin de Massy, 91882 Massy Cedex, France, Telephone: (33)1 69 53 71 00, Fax: (33)1 69 53 71 10 E-mail: infos@hamamatsu.fr

United Kingdom: Hamamatsu Photonics UK Limited: 2 Howard Court, 10 Tewin Road Welwyn Garden City Hertfordshire AL7 1BW, United Kingdom, Telephone: 44-(0)1707-294888, Fax: 44(0)1707-325777 E-mail: info@hamamatsu.co.uk

North Europe: Hamamatsu Photonics Norden AB: Torshamnsgatan 35 SE-164 40 Kista, Sweden, Telephone: (46)8-509-031-00, Fax: (46)8-509-031-01 E-mail: info@hamamatsu.se

Italy: Hamamatsu Photonics Italia: S.R.L.: Strada della Moia, 1/E, 20020 Arese, (Milano), Italy, Telephone: (39)02-935 81 733, Fax: (39)02-935 81 741 E-mail: info@hamamatsu.it

China: Hamamatsu Photonics (China) Co., Ltd.: 1201 Tower B, Jiaming Center, 27 Dongsanhuan Road North, Chaoyang District, Beijing 100020, China, Telephone: (86)10-6586-6006, Fax: (86)10-6586-2866 E-mail: hpc@hamamatsu.com.cn

Cat. No. LQCL2001E04
SEPT. 2013 IP
(1000)