

QT-Brightek PLCC Series
PLCC6 RGB LED (White Face)
Part No.: QBLP679-RGB5

Product: QBLP679-RGB5	Date: February 18, 2015	Page 1 of 10
	Version# 2.2	

Table of Contents:

Introduction	3
Electrical / Optical Characteristic (Ta=25 °C)	4
Absolute Maximum Rating	4
Characteristic Curves.....	6
Solder Profile & Footprint.....	7
Packing	8
Labeling	9
Ordering Information	9
Revision History	10
Disclaimer	10

Introduction

Feature:

- Clear Lens
- Silicone epoxy
- Package in tape and reel
- Ultra bright PLCC6 RGB LED
- InGaN technology for IB/IG
- AlInGaP technology for R
- 120 degree viewing angle
- White Face

Description:

This ultra bright PLCC6 RGB LEDs have a height profile of 1.60mm. Combination of high brightness output and white face color, this LED is ideal for architecture lighting, status indication, and color mixing applications.

Application:

- Status indication
- Back lighting application
- Architecture lighting

Certification & Compliance:

- TS16949
- ISO9001
- RoHS Compliant



Dimension:

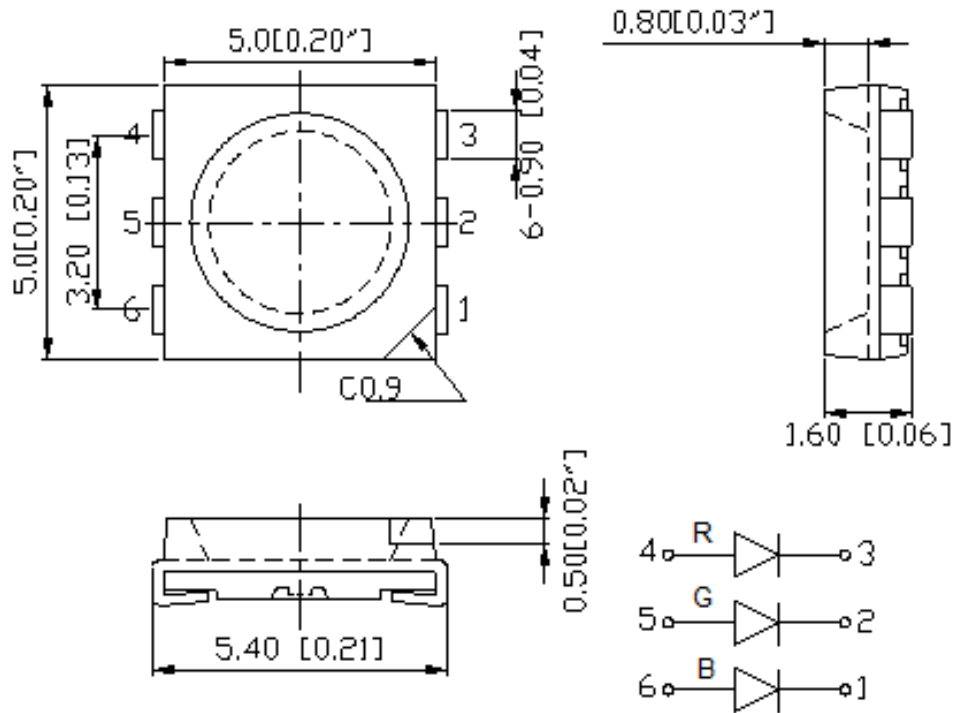

Units: mm / tolerance = +/-0.1mm

Electrical / Optical Characteristic (Ta=25 °C)

Product	Color	I _F (mA)	V _F (V)		λ _D (nm)			I _V (mcd)	
			Typ.	Max.	Min.	Typ.	Max.	Min.	Typ.
QBLP679-RGB5	Red	20	2.0	2.5	615	625	630	400	700
	True Green	20	3.2	3.7	520	525	535	1000	1650
	Blue	20	3.2	3.7	461	471	476	200	300

Absolute Maximum Rating

Material	P _d (mW)	I _F (mA)	I _{FP} (mA)*	V _R (V)	T _{OP} (°C)	T _{ST} (°C)	T _{SOL} (°C)**
AllInGaP (R)	75	30	125	5	-40 to +80	-40 to +85	260
InGaN (IB/IG)	111	30	125	5	-40 to +80	-40 to +85	260

*Duty 1/8 @ 1KHz

**IR Reflow for no more than 10 sec @ 260 °C

Luminous Intensity I_V for Red @ I_F=20mA

Bin	Min.	Max.	Unit
12	400	575	mcd
13	575	720	
14	720	900	
15	900	1125	

Luminous Intensity I_V for True Green @ I_F=20mA

Bin	Min.	Max.	Unit
12	1000	1280	mcd
13	1280	1600	
14	1600	2000	
15	2000	2500	

Luminous Intensity I_V for Blue @ I_F=20mA

Bin	Min.	Max.	Unit
10	200	250	mcd
11	245	305	
12	305	385	
13	385	480	

Dominant Wavelength λ_D for Red @ $I_F=20\text{mA}$

Bin	Min.	Max.	Unit
1	615	620	nm
2	620	625	
3	625	630	

Dominant Wavelength λ_D for True Green @ $I_F=20\text{mA}$

Bin	Min.	Max.	Unit
2	520	525	nm
3	525	530	
4	530	535	

Dominant Wavelength λ_D for Blue @ $I_F=20\text{mA}$

Bin	Min.	Max.	Unit
2	461	466	nm
3	466	471	
4	471	476	

Characteristic Curves

Fig.1 IF-VF(Ta=25°C)

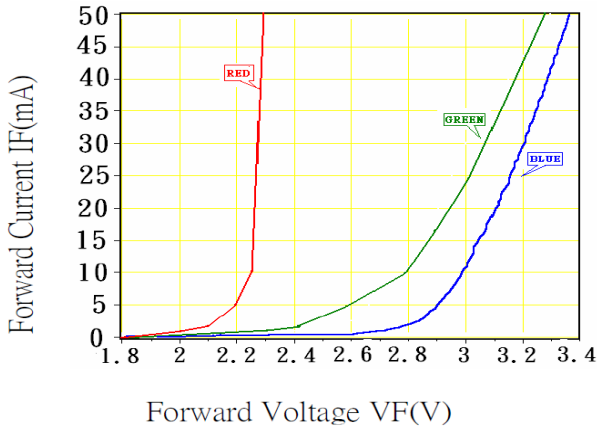

Fig.2 Relative Luminous Intensity-IF (Ta=25°C)

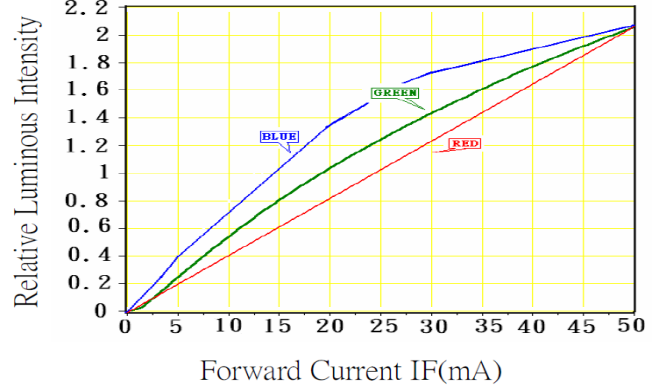
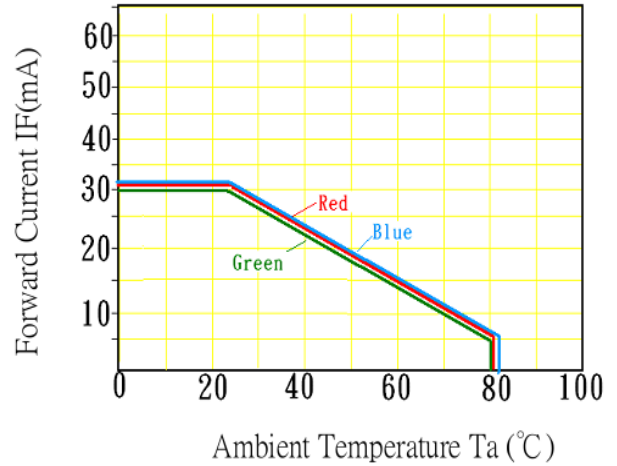
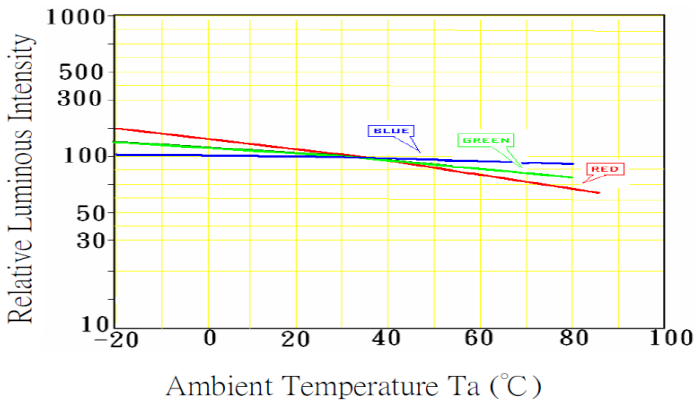
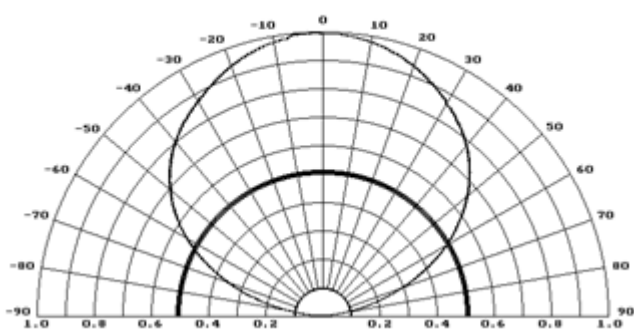

Fig.3 Relative Luminous Intensity-Ta



Directive Characteristics



Wavelength Characteristics (Ta=25°C)

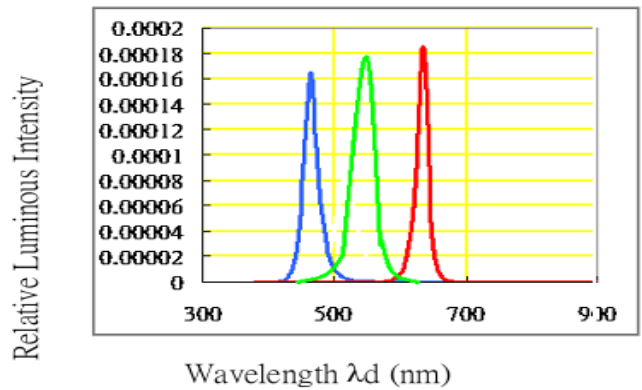

Solder Profile & Footprint

- Recommended tin solder specifications: melting temperature in the range of 178~192 °C
- The recommended reflow soldering profile is as follows (temperatures indicated are as measured on the surface of the LED resin):

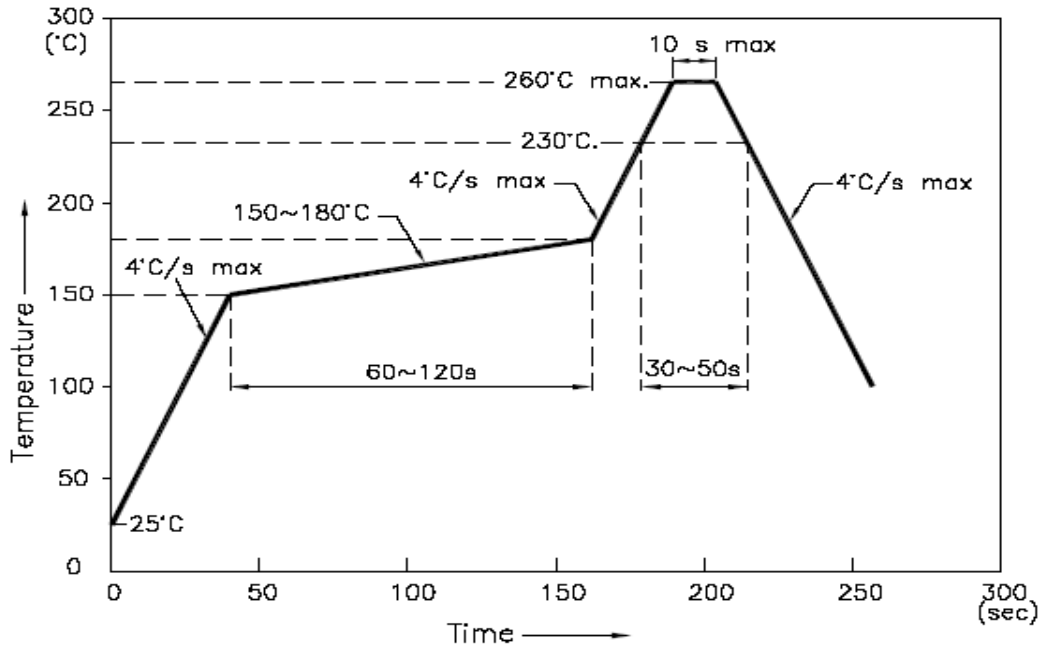

RECOMMEND PAD LAYOUT

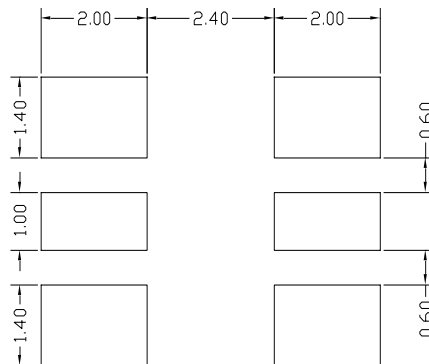

Units: mm

tolerance: +/- 0.1mm

Packing

Reel Dimension:

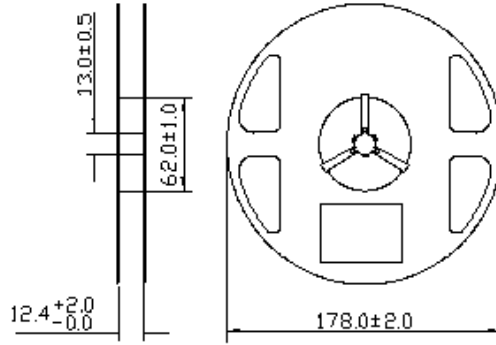

Unit: mm

Tape Dimension:

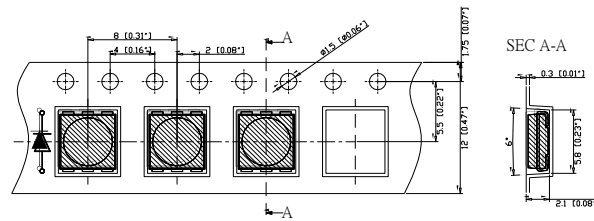

Unit: mm

Arrangement of Tape:

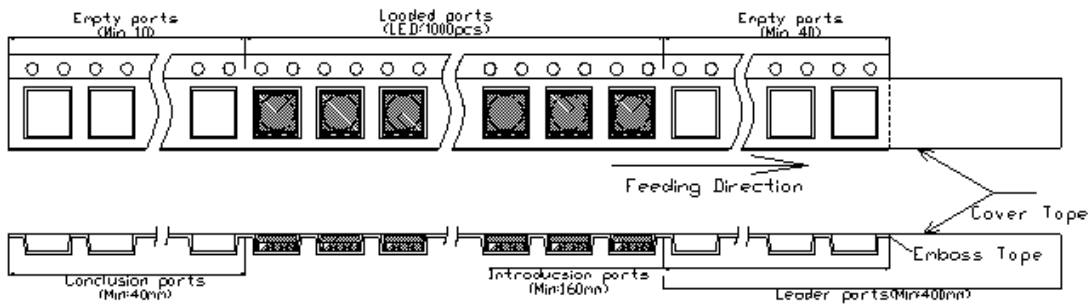

Packaging Specifications:

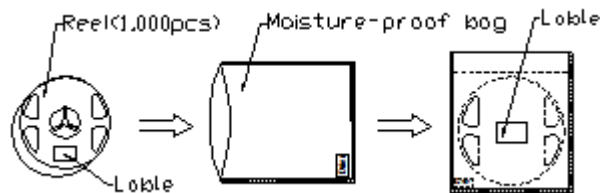

Product: QBLP679-RGB5	Date: February 18, 2015	Page 8 of 10
	Version# 2.2	

Labeling

Part No: _____

Customer P/N: _____

Item: _____

Q'ty: _____

Vf: _____

Iv: _____

Wl: _____

Date: _____

Made in China**Ordering Information**

Part #	Orderable Part #	Spec Range	Quantity per reel
QBLP679-RGB5	QBLP679-RGB5	Red: Iv=700mcd typ. @ 20mA / $\lambda_D=615\text{nm to }630\text{nm}$	1,000 units
		True Green: Iv=1650mcd typ. @ 20mA / $\lambda_D=520\text{nm to }535\text{nm}$	
		Blue: Iv=300mcd typ. @ 20mA / $\lambda_D=461\text{nm to }476\text{nm}$	

Revision History

Description:	Revision #	Revision Date
New Release of QBLP679-RGB5	V1.0	09/20/2010
Information Updates	V1.1	02/16/2011
Update format and spec	V1.2	04/25/2012
Amend the brightness	V2.0	06/26/2013
Update spec	V2.1	01/20/2014
Update dimensions drawing	V2.2	02/18/2015

Disclaimer

QT-BRIGHTTEK reserves the right to make changes without further notice to any products herein to improve reliability, function or design. QT-BRIGHTTEK does not assume any liability arising out of the application or use of any product or circuit described herein; neither does it convey any license under its patent rights, nor the rights of others.

Life Support Policy

QT-BRIGHTTEK's products are not authorized for use as critical components in life support devices or systems without the express written approval of QT-BRIGHTTEK. As used herein:

1. Life support devices or systems are devices or systems which, (a) are intended for surgical implant into the body, or (b) support or sustain life, and (c) whose failure to perform when properly used in accordance with instructions for use provided in the labeling, can be reasonably expected to result in a significant injury of the user.
2. A critical component in any component of a life support device or system whose failure to perform can be reasonably expected to cause the failure of the life support device or system, or to affect its safety or effectiveness.