

Features

- Surge overload ratings to 30 amperes peak.
- Save space on printed circuit board.
- Ideal for automated replacement.
- Reliable low cost construction utilizing molded plastic technology results in inexpensive product.
- Glass passivated chip junctions.
- Lead-free parts meet RoHS requirements.
- UL recognized file # E321971
- Suffix "-H" indicates Halogen free part, ex. MB05S-H.

Mechanical data

- Epoxy:UL94-V0 rated flame retardant
- Case : Molded plastic, TO-269AA (MDS)
- Terminals : Solder plated, solderable per MIL-STD-750, Method 2026
- Polarity : marked on body
- Mounting Position : Any

Package outline

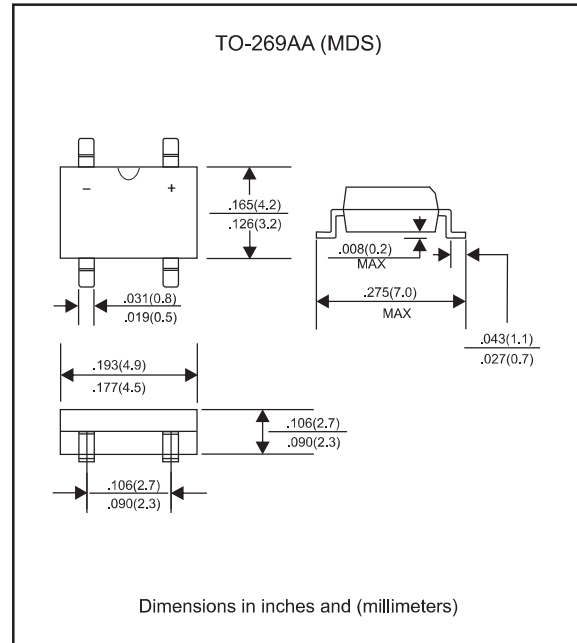

Maximum ratings and Electrical Characteristics (AT $T_A=25^\circ\text{C}$ unless otherwise noted)

PARAMETER	CONDITIONS	Symbol	MIN.	TYP.	MAX.	UNIT
Forward rectified current	On glass-epoxy P.C.B. On aluminum substrate	I_O			0.5 0.8	A
Forward surge current	8.3ms single half sine-wave superimposed on rate load (JEDEC method)	I_{FSM}			30	A
Reverse current	$V_R = V_{RRM}$ $T_J = 25^\circ\text{C}$	I_R			5.0	uA
	$V_R = V_{RRM}$ $T_J = 125^\circ\text{C}$				200	
Thermal resistance	Junction to ambient	$R_{\theta JA}$		85		$^\circ\text{C/W}$
Diode junction capacitance	f=1MHz and applied 4V DC reverse voltage	C_J		13		pF
Storage temperature		T_{STG}	-55		+150	$^\circ\text{C}$

SYMBOLS	V_{RRM}^{*1} (V)	V_{RMS}^{*2} (V)	V_R^{*3} (V)	V_F^{*4} (V)	Operating temperature T_J ($^\circ\text{C}$)
MB05S	50	35	50	1.00	-55 to +150
MB1S	100	70	100		
MB2S	200	140	200		
MB4S	400	280	400		
MB6S	600	420	600		
MB8S	800	560	800		
MB10S	1000	700	1000		

- *1 Repetitive peak reverse voltage
- *2 RMS voltage
- *3 Continuous reverse voltage
- *4 Maximum forward voltage per element at 0.8A peak

Rating and characteristic curves (MB05S THRU MB10S)

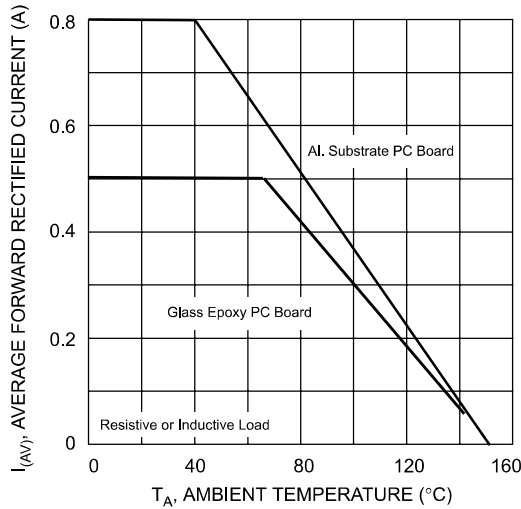

Fig. 1 Output Current Derating Curve

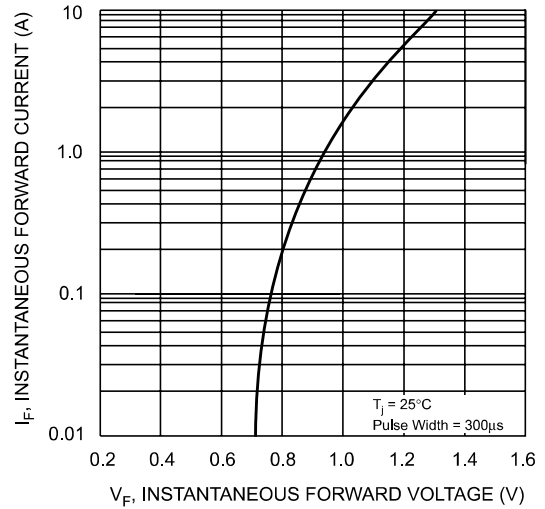

Fig. 2 Typical Forward Characteristics (per leg)

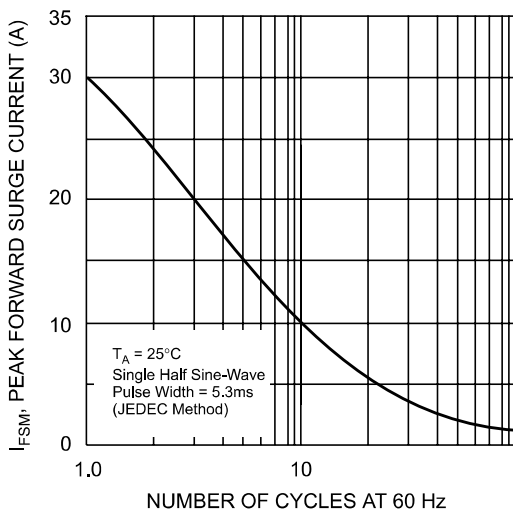

Fig. 3 Maximum Peak Forward Surge Current (per leg)

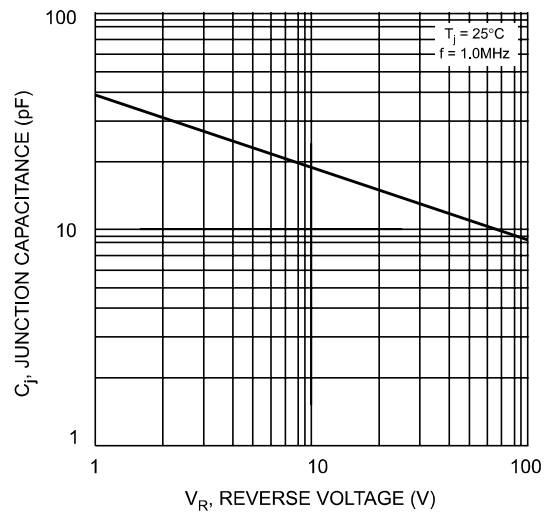

Fig. 4 Typical Junction Capacitance

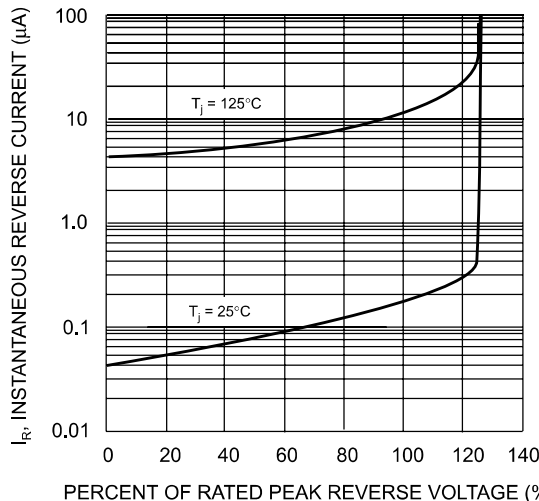
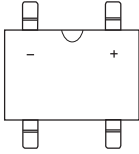
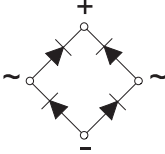
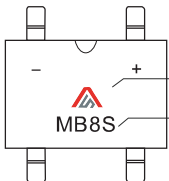
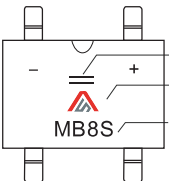

Fig. 5 Typical Reverse Characteristics (per element)

Pinning information

Simplified outline	Symbol
	

Marking

Type number	Marking code	Example	
MB05S	MB05S	1. For Halogen Device	2. For Halogen-free Device
MB1S	MB1S		
MB2S	MB2S		
MB4S	MB4S		
MB6S	MB6S		
MB8S	MB8S		
MB8S	MB8S		
MB10S	MB10S		

Suggested solder pad layout

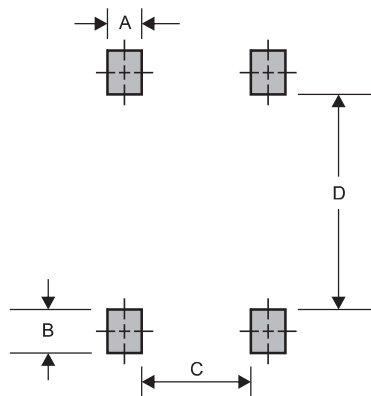

Dimensions in inches and (millimeters)

PACKAGE	A	B	C	D
TO-269AA (MDS)	0.023 (0.58)	0.030 (0.76)	0.070 (1.78)	0.226 (5.75)