



### OUTSTANDING CHARACTERISTICS

- Miniature size
- Very high Q at high frequencies
- High RF power capabilities
- Impervious to environmental conditions
- Low dissipation factors
- Excellent retrace capability (not applicable for X7R styles)
- High temperature stability
- Low noise
- Meets Mil-55681 with respect to: Shock, Vibration, Moisture Resistance, Solderability, Barometric Pressure, Temperature Cycling, Immersion and Salt Spray

### ADDITIONAL FEATURES

- Packaging options
- Lot processing data available

### MA SERIES

For filtering, coupling and impedance matching in most RF circuits, the MA Series chips and leaded devices offer outstanding performance and reliability with the greatest range of values and configurations. MA Series capacitors can be supplied with military equivalent screening. Please consult our factory.

MA Series ceramic fixed capacitors are miniature, high performance precision components having extremely high Q and high power capabilities from low frequencies to gigahertz ranges. These "low loss" multilayer capacitors are extremely stable with respect to variations in temperature, voltage and frequency.

MA Series capacitors are designed for miniature state-of-the-art circuit applications. They are small,

easy to apply and have excellent reliability. Units are available in ultra-miniature case size 1 (1.4 x 1.4 x 1.4mm) or miniature case size 2 (2.8 x 2.8 x 2.5mm). Standard case size 1 units are available as chips. Standard case size 2 units are available as chips and also in leaded configurations.

Clean-room manufacturing technology assures product reliability and automated processing reduces costs and cycle time. Key stages of the operation are monitored and controlled with the latest SPC techniques. Flexibility in design allows the production of non-standard values, while maintaining consistent quality objectives.

Please contact the factory for availability of special configurations or high-reliability screening.

### PART NUMBERING SYSTEM – CASE SIZE 1 & CASE SIZE 2

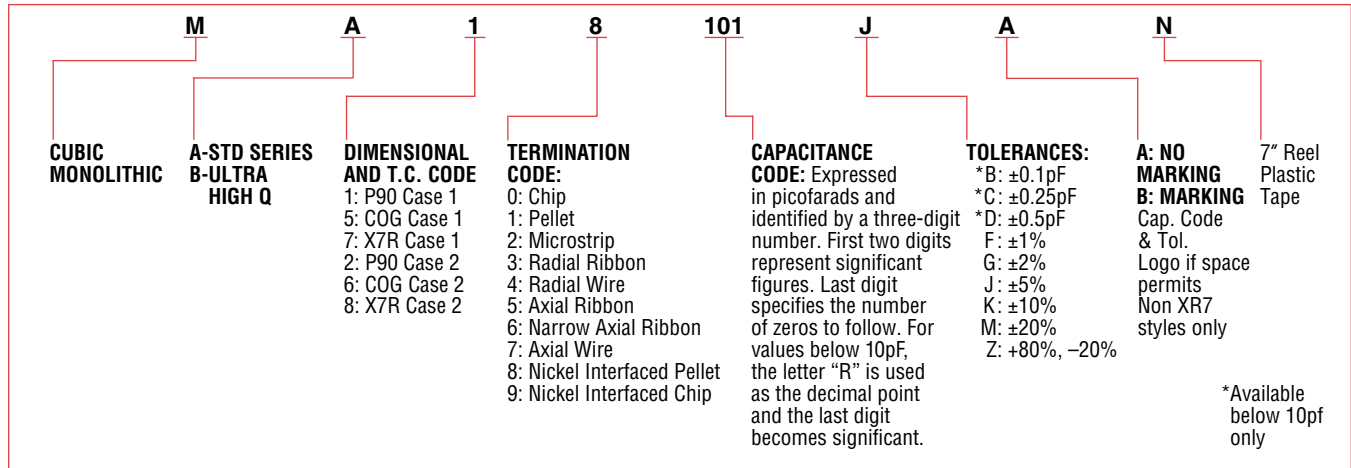

### SPECIAL LEAD CONFIGURATION FOR FLEX BOARDS



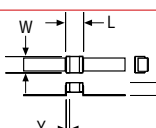



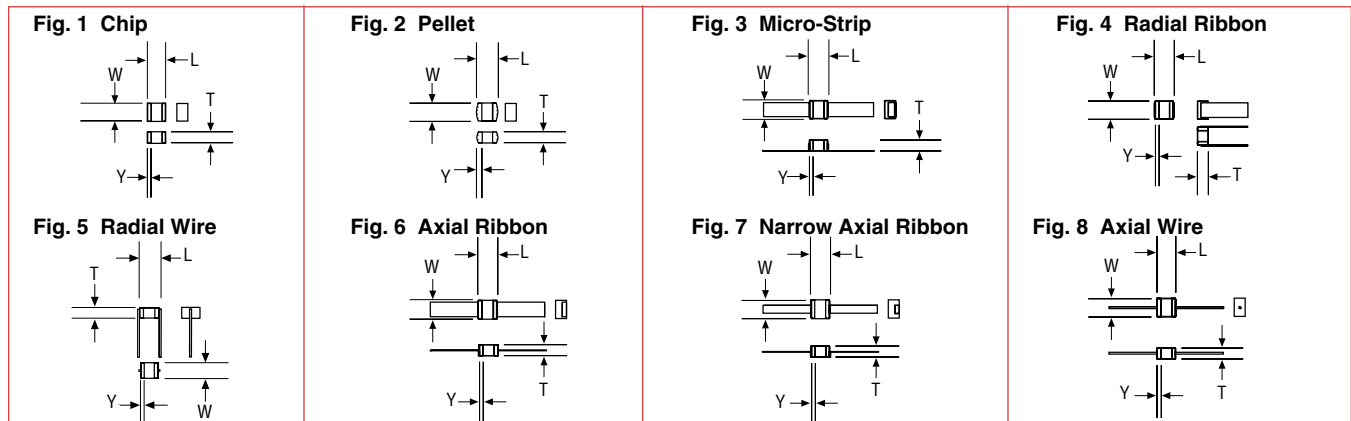







**NOTE:** Targeted for flex circuit boards, the MA22-6 version of the MA22 has an upraised lead configuration. The lead bends when flexing the board after assembly so that minimal stress is placed on the component.

Style	Type				Configuration	Dimensions: mm				Termination
	P90 ± 20	P90 ± 30	COG	X7R		L ± 0.38*	W ± 0.38*	T ± .038	Band Y	
<b>NEW</b> Raised Micro-Strip	MA22-6	MB22-6	MA62-6	MA82-6		3.4	2.8	2.8	0.38 ± .25	Silver Ribbon: Length: 6.35 typical Width: 2.3 ± .13 Thickness: 0.1 ± .05

### DIMENSIONS



### CONFIGURATION AND DIMENSIONS – MA & MB SERIES

Style	Type				Figure	Case Size	Configuration	Dimensions: mm			Band Y	Termination
	P90 ± 20	P90 ± 30	COG	X7R				L ± 0.38*	W ± 0.38*	T max.		
Chip	MA10	—	MA50	MA70	1	1 EIA Style 0505		1.4 ± .25	1.4 ± .25	1.4	0.25 ± .1	Palladium Silver
Pellet	MA11	—	MA51	MA71	2			1.8 max.				Palladium Silver & Sn62 Solder
Nickel Interfaced Pellet	MA18	—	MA58	MA78	2			1.4 ± .25				Palladium Silver, Nickel Interface & Sn62 Solder
Nickel Interfaced Chip	MA19	—	MA59	MA79	1			1.4 ± .25				Palladium Silver, Nickel Interface & Tin Plating
Chip	MA20	MB20	MA60	MA80	1	2 EIA Style 1010		2.8	2.8	2.5	0.38 ± .25	Palladium Silver
Pellet	MA21	MB21	MA61	MA81	2			3.3 max.				Palladium Silver, & Sn62 Solder
Micro Strip	MA22	MB22	MA62	MA82	3			3.4				Silver Ribbon: 6.35 x 2.3 x 0.1mm
Radial Ribbon	MA23	MB23	MA63	MA83	4			3.4				Silver Ribbon: 6.35 x 2.3 x 0.1mm
Radial Wire	MA24	MB24	MA64	MA84	5			3.8				#26AWG Silver Wire: 12.7 x 0.4mm Dia.
Axial Ribbon	MA25	MB25	MA65	MA85	6			3.4				Silver Ribbon: 6.35 x 2.3 x 0.1mm
Narrow Axial Ribbon	MA26	MB26	MA66	MA86	7			3.4				Silver Ribbon: 6.35 x 1.25 x 0.1mm
Axial Wire	MA27	MB27	MA67	MA87	8			3.8				#26AWG Silver Wire: 12.7mm x 0.4mm Dia.
Nickel Interfaced Pellet	MA28	MB28	MA68	MA88	2			3.3 max.				Palladium Silver, Nickel Interface & Sn62 Solder
Nickel Interfaced Chip	MA29	MB29	MA69	MA89	1			2.8				Palladium Silver, Nickel Interface & Tin Plating

\*Except where Tolerance is shown. Lead lengths are typical widths ±0.1mm, thickness & dia. ±0.05mm. All leaded parts are bonded with high temperature solder 748°F/398°C.

# APPLICATION SPECIFIC CAPACITORS MINIATURE MICROWAVE CERAMIC CAPACITORS



## MA Case Size 1 Series

### MA10 & 50 SERIES, P90 & COG – CASE SIZE 1

Cap. Code	Cap. pF	Cap. Tol.	WVDC*
0R1	0.1	B	150
0R2	0.2	"	150
0R3	0.3	B,C	150
0R4	0.4	"	150
0R5	0.5	B,C,D	150
0R6	0.6	"	150
0R7	0.7	"	150
0R8	0.8	"	150
0R9	0.9	"	150
1R0	1.0	"	150
1R1	1.1	"	150
1R2	1.2	"	150
1R3	1.3	"	150
1R4	1.4	"	150
1R5	1.5	"	150
1R6	1.6	"	150
1R7	1.7	"	150
1R8	1.8	"	150
1R9	1.9	"	150
2R0	2.0	"	150
2R2	2.2	"	150
2R4	2.4	"	150
2R7	2.7	"	150
3R0	3.0	"	150
3R3	3.3	"	150
3R6	3.6	"	150
3R9	3.9	"	150
4R3	4.3	"	150

\*@ 125°C

Cap. Code	Cap. pF	Cap. Tol.	WVDC*
4R7	4.7	B,C,D	150
5R1	5.1	"	150
5R6	5.6	"	150
6R2	6.2	"	150
6R8	6.8	B,C,J,K,M	150
7R5	7.5	"	150
8R2	8.2	"	150
9R1	9.1	"	150
100	10	F,G,J,K,M	150
110	11	"	150
120	12	"	150
130	13	"	150
150	15	"	150
160	16	"	150
180	18	"	150
200	20	"	150
220	22	"	150
240	24	"	150
270	27	"	150
300	30	"	150
330	33	"	150
360	36	"	150
390	39	"	150
430	43	"	150
470	47	"	150
510	51	"	150
560	56	"	150
620	62	"	150

\*@ 125°C

Cap. Code	Cap. pF	Cap. Tol.	WVDC*
680	68	F,G,J,K,M	150
750	75	"	150
820	82	"	150
910	91	"	150
101	100	"	150
111**	110	"	50
121**	120	"	50
131**	130	"	50
151**	150	"	50
161**	160	"	50
181**	180	"	50
201**	200	"	50
221**	220	"	50
241**	240	"	50
271**	270	"	50
301**	300	"	50
331**	330	"	50
361**	360	"	50
391**	390	"	50
431**	430	"	50
471**	470	"	50
511**	510	"	50
561**	560	"	50
621**	620	"	50
681**	680	"	50
751**	750	"	50
821**	820	"	50
911**	910	"	50
102**	1000	"	50

\*@ 125°C

\*\*Extended Cap Range, COG only

### MA70 SERIES, X7R – CASE SIZE 1

Cap. Code	Cap. pF	Cap. Tol.	WVDC***
511	510	K,M,Z	50
561	560	"	50
621	620	"	50
681	680	"	50
751	750	"	50
821	820	"	50
911	910	"	50
102	1000	"	50
112	1100	"	50
122	1200	"	50
132	1300	"	50

\*\*\*@ 85°C

Cap. Code	Cap. pF	Cap. Tol.	WVDC***
152	1500	K,M,Z	50
162	1600	"	50
182	1800	"	50
202	2000	"	50
222	2200	"	50
242	2400	"	50
272	2700	"	50
302	3000	"	50
332	3300	"	50
362	3600	"	50
392	3900	"	50

\*\*\*@ 85°C

Cap. Code	Cap. pF	Cap. Tol.	WVDC***
432	4300	K,M,Z	50
472	4700	"	50
512	5100	"	50
562	5600	"	50
622	6200	"	50
682	6800	"	50
752	7500	"	50
822	8200	"	50
912	9100	"	50
103	10000	"	50

\*\*\*@ 85°C

# APPLICATION SPECIFIC CAPACITORS MINIATURE MICROWAVE CERAMIC CAPACITORS



## MA Case Size 2 Series

### MA20 & 60 SERIES, P90 & COG – CASE SIZE 2

Cap. Code	Cap. pF	Cap. Tol.	WVDC*
0R1	0.1	B	500
0R2	0.2	"	500
0R3	0.3	B,C	500
0R4	0.4	"	500
0R5	0.5	B,C,D	500
0R6	0.6	"	500
0R7	0.7	"	500
0R8	0.8	"	500
0R9	0.9	"	500
1R0	1.0	"	500
1R1	1.1	"	500
1R2	1.2	"	500
1R3	1.3	"	500
1R4	1.4	"	500
1R5	1.5	"	500
1R6	1.6	"	500
1R7	1.7	"	500
1R8	1.8	"	500
1R9	1.9	"	500
2R0	2.0	"	500
2R1	2.1	"	500
2R2	2.2	"	500
2R4	2.4	"	500
2R7	2.7	"	500
3R0	3.0	"	500
3R3	3.3	"	500
3R6	3.6	"	500
3R9	3.9	"	500
4R3	4.3	"	500
4R7	4.7	"	500
5R1	5.1	"	500
5R6	5.6	"	500
6R2	6.2	"	500
6R8	6.8	B,C,J,K,M	500

\*@ 125°C

Note: Limited capacitance range available in 1Kv; consult factory.

Cap. Code	Cap. pF	Cap. Tol.	WVDC*
7R5	7.5	"	500
8R2	8.2	B,C,J,K,M	500
9R1	9.1	"	500
100	10	F,G,J,K,M	500
110	11	"	500
120	12	"	500
130	13	"	500
150	15	"	500
160	16	"	500
180	18	"	500
200	20	"	500
220	22	"	500
240	24	"	500
270	27	"	500
300	30	"	500
330	33	"	500
360	36	"	500
390	39	"	500
430	43	"	500
470	47	"	500
510	51	"	500
560	56	"	500
620	62	"	500
680	68	"	500
750	75	"	500
820	82	"	500
910	91	"	500
101	100	"	500
111	110	"	300
121	120	"	300
131	130	"	300
151	150	"	300
161	160	"	300
181	180	"	300

\*@ 125°C

Cap. Code	Cap. pF	Cap. Tol.	WVDC*
201	200	"	300
221	220	"	200
241	240	F,G,J,K,M	200
271	270	"	200
301	300	"	200
331	330	"	200
361	360	"	200
391	390	"	200
431	430	"	200
471	470	"	200
511	510	"	100
561	560	"	100
621	620	"	100
681	680	"	50
751	750	"	50
821	820	"	50
911	910	"	50
102	1000	"	50
112**	1100	"	50
122**	1200	"	50
132**	1300	"	50
152**	1500	"	50
162**	1600	"	50
182**	1800	"	50
202**	2000	"	50
222**	2200	"	50
242**	2400	"	50
272**	2700	"	50
302**	3000	"	50
332**	3300	"	50
362**	3600	"	50
392**	3900	"	50
432**	4300	"	50
472**	4700	"	50
512**	5200	"	50

\*@ 125°C

\*\*Extended Cap Range, COG only

APPLICATION SPECIFIC CAPACITORS

### MA80 SERIES, X7R – CASE SIZE 2

Cap. Code	Cap. pF	Cap. Tol.	WVDC**
512	5100	K,M,Z	100
562	5600	"	100
622	6200	"	100
682	6800	"	100
752	7500	"	100
822	8200	"	100
912	9100	"	100
103	10000	"	100
113	11000	"	100
123	12000	"	100
133	13000	"	100

\*\*@ 85°C

Cap. Code	Cap. pF	Cap. Tol.	WVDC**
153	15000	K,M,Z	100
163	16000	"	100
183	18000	"	100
203	20000	"	100
223	22000	"	100
243	24000	"	100
273	27000	"	100
303	30000	"	100
333	33000	"	100
363	36000	"	100
393	39000	"	100

\*\*@ 85°C

Cap. Code	Cap. pF	Cap. Tol.	WVDC**
433	43000	K,M,Z	100
473	47000	"	100
513	51000	"	100
563	56000	"	100
623	62000	"	100
683	68000	"	100
753	75000	"	100
823	82000	"	100
913	91000	"	100
104	100000	"	100

\*\*@ 85°C

# APPLICATION SPECIFIC CAPACITORS MINIATURE MICROWAVE CERAMIC CAPACITORS



## MB Case Size 2 Series

### MB20 ~ 29 SERIES, P90 ± 30 – CASE SIZE 2

Cap. Code	Cap. pF	Cap. Tol.	WVDC*
0R4	0.4	B,C	1000
0R5	0.5	B,C,D	1000
0R6	0.6	"	1000
0R7	0.7	"	1000
0R8	0.8	"	1000
0R9	0.9	"	1000
1R0	1.0	"	1000
1R1	1.1	"	1000
1R2	1.2	"	1000
1R3	1.3	"	1000
1R4	1.4	"	1000
1R5	1.5	"	1000
1R6	1.6	"	1000
1R7	1.7	"	1000
1R8	1.8	"	1000
1R9	1.9	"	1000
2R0	2.0	"	1000
2R1	2.1	"	1000
2R2	2.2	"	1000
2R4	2.4	"	1000
2R7	2.7	"	1000
3R0	3.0	"	1000
3R3	3.3	"	1000
3R6	3.6	"	1000
3R9	3.9	"	1000

\*@ 125°C

Cap. Code	Cap. pF	Cap. Tol.	WVDC*
4R3	4.3	B,C,D	1000
4R7	4.7	"	1000
5R1	5.1	"	1000
5R6	5.6	"	1000
6R2	6.2	"	1000
6R8	6.8	B,C,J,K,M	1000
7R5	7.5	"	1000
8R2	8.2	"	1000
9R1	9.1	"	1000
100	10	F,G,J,K,M	500
110	11	"	500
120	12	"	500
130	13	"	500
150	15	"	500
160	16	"	500
180	18	"	500
200	20	"	500
220	22	"	500
240	24	"	500
270	27	"	500
300	30	"	500
330	33	"	500
360	36	"	500
390	39	"	500
430	43	"	500

\*@ 125°C

Cap. Code	Cap. pF	Cap. Tol.	WVDC*
470	47	F,G,J,K,M	300
510	51	"	300
560	56	"	300
620	62	"	300
680	68	"	100
750	75	"	100
820	82	"	100
910	91	"	100
101	100	"	100

\*@ 125°C

### SPECIFICATIONS

<b>Dissipation Factor</b>	MA/MB 18/28; 0.05% maximum MA 58/68; 0.15% maximum @ 1.0VRMS (f = 1 MHz) MA 78/88; 2.5% maximum @ 1.0VRMS maximum (f = 1kHz)
<b>Temperature Coefficient</b>	MB28 Series P90±30ppm/°C, (-55°C to +175°C) MA 18/28 Series P90 ±20ppm/°C, (-55°C to +125°C) MA 58/68 Series; COG (0 ±30ppm/°C, -55°C to +125°C) MA 78/88 Series; ±15% maximum (-55°C to +125°C)
<b>Insulation Resistance</b>	MA/MB 18/28 1000K M Ohms at +25°C, 100K M Ohms at +125°C MA 58/68 1000K M Ohms at +25°C, 100K M Ohms at +125°C MA 78/88 100K M Ohms or 1000 M Ohm µF min., whichever is less (@ 25°C) 10K M Ohms or 100 M Ohms µF min., whichever is less (@ 125°C)
<b>Dielectric Test Voltage</b>	MA/MB 18/28/58/68/78/88, 250% of WVDC for 5 seconds
<b>Capacitance Drift</b>	Meets or Exceeds MIL-PRF-55681 (Does not apply for MA 78/88)
<b>Aging</b>	Negligible for MA/MB 18/28/58/68, MA 78/88; 2.5% per decade maximum
<b>Environmental Tests</b>	MIL-STD-202
<b>Shock</b>	Method 213, Condition J
<b>Vibration</b>	Method 204, Condition B
<b>Moisture Resistance</b>	Method 106
<b>Solderability</b>	Method 208
<b>Immersion</b>	Method 104, Condition B
<b>Barometric Pressure</b>	Method 105, Condition B
<b>Resistance to Soldering Heat</b>	Method 210, Condition B
<b>Thermal Shock</b>	Method 107, Condition A
<b>Life</b>	Method 108, Condition F
<b>Marking</b>	Standard MA/MB product is unmarked

APPLICATION SPECIFIC CAPACITORS

### TAPE AND REEL PACKAGING

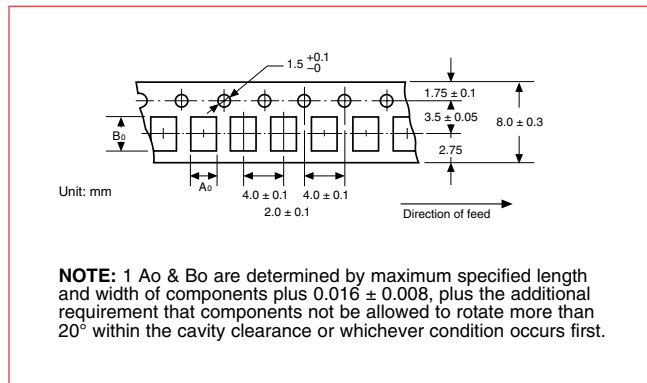

### DIMENSIONS: mm

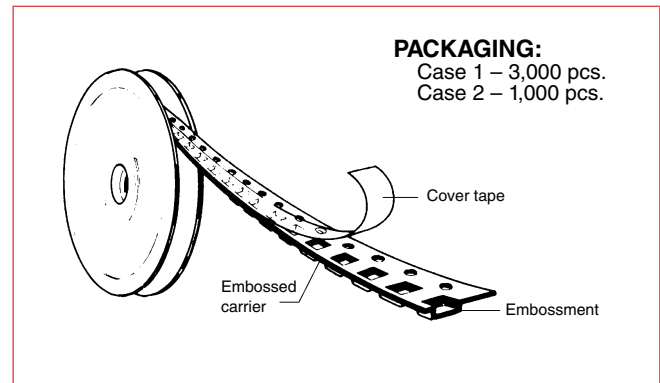

### CONDUCTIVE TAPE

Advantages	Benefits
Conductive	Prevents static charge build-up
Flexibility	Insures against crazing, cracking and brittleness
Dimensional strength	Drive loading will not elongate sprocket holes
Dimensional stability	Smooth, reliable running on pick and place machines

### ELECTRICAL PROPERTIES

Property	Value	Test Method
Resistivity	5 x 10 <sup>5</sup> ohm/square	ASTM D-257
Electrostatic Decay Time At 50% RH@21°C	0.01 Sec.	ASTM D-257

Typical Values

Other packaging options available — Consult Factory