14 Pin DIL Uncooled Laser Modules

Technical Data

Features

- **Low Cost Plastic Package (14 Pin DIL)**
- **LSC3300: 100 μ W (-10 dBm) Min. Power Output**
LSC3100: 1 mW (0 dBm) Min. Power Output
- **1280 - 1330 nm Wavelength**
- **Hermetic Laser Module**
- **-40°C to +85°C Operation**

Applications

- **Telecommunications**
- **Local Area and Metropolitan Area Networks**
- **Point to Point Datacommunications**
- **Fiber Optic Sensors**
- **Cable Television**
- **Military Communications and Control Systems**
- **Instrumentation**

Description

LSC3X00 laser modules are high reliability fiber optic light sources operating in the 1300 nanometer band. They are particularly well suited for applications where low power dissipation is required.

The internal semiconductor lasers are based upon InGaAsP buried heterostructure (BH) technology and fabricated by the Metal-Organic Vapor Phase Epitaxy (MOVPE) process, resulting in long lifetimes and modest threshold currents.

The LSC3X00 package includes a photodiode for monitoring the laser output. A longhorn type heatsink mounting flange is incorporated in the industry standard 14 pin DIL package.

Two basic varieties are offered for alternative power ranges. The “low power” LSC3300 covers the power range between 100 μ W

LSC3X00



and 625 μ W. The “high power” LSC3100 uses the same laser chip, but with tighter fiber coupling to achieve output powers from 1 mW to 2.5 mW.

The low cost outer package is made feasible by our unique design of hermetic miniature laser submodule which houses the electro-optic devices. The submodule concept is used as a building block in many other Hewlett-Packard products including cooled 1 mW 14 pin lasers and DFB modules.

Laser Safety Warning

This device is a Class IIIb (3b) Laser Product. It may emit invisible laser radiation if operated with the fiber pigtail disconnected. To avoid possible eye damage do not look into an unconnected fiber pigtail during laser operation. Do not exceed specified operating limits.

LSC3X00 Pin Connections and Block Diagram

Top View

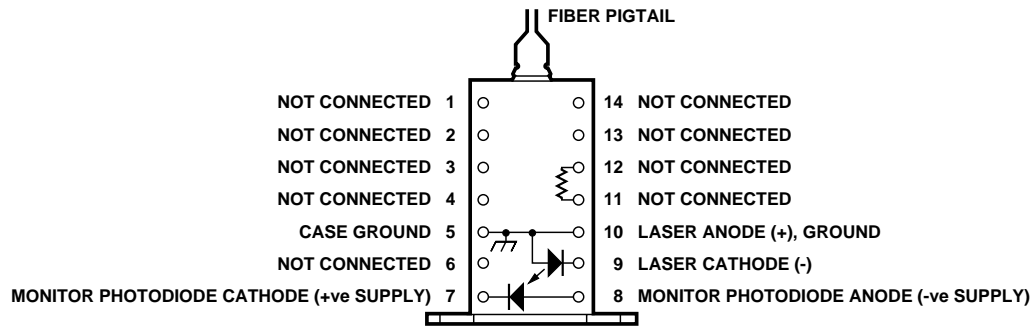

LSC3X00 Mechanical Outline - Dimensions in mm

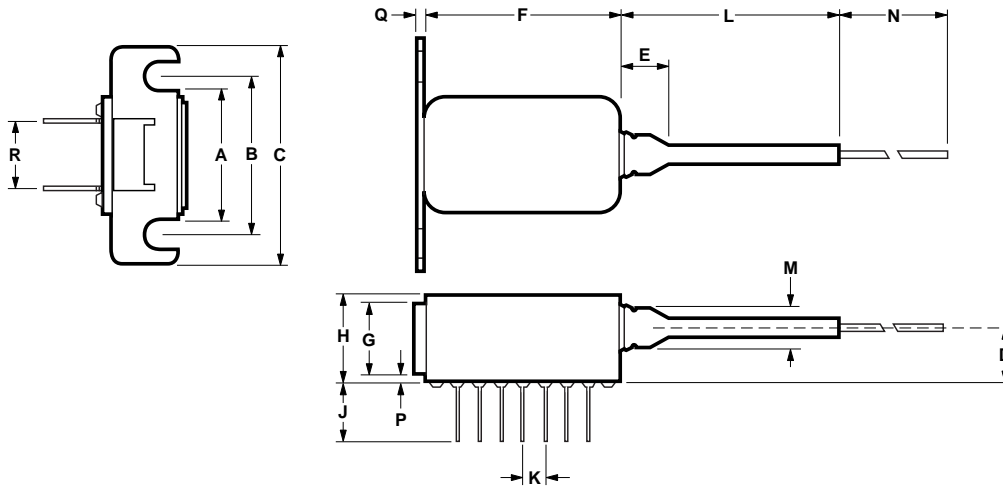

DIM.	MIN.	MAX.	DIM.	MIN.	MAX.
A	12.6	12.8	J	5.5	5.9
B	19.05 NOM.		K	2.52 NOM.	
C	25.3	25.5	L	25.0 NOM.	
D	6.4	6.8	M	-	4.2
E	-	6.0	N	800	-
F	21.33	21.53	P	1.5	1.8
G	7.01	7.21	Q	0.99	1.05
H	9.40	9.60	R	7.62 NOM.	

ALL DIMENSIONS IN MILLIMETERS

LSC3X00 Laser Diode Typical Operating Characteristics

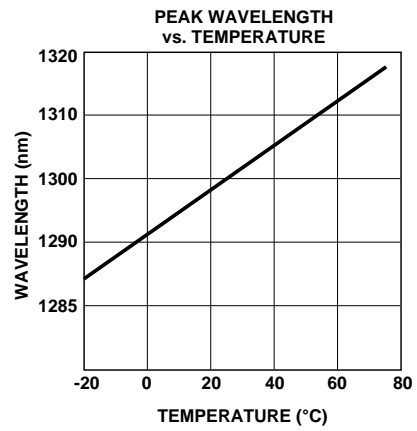
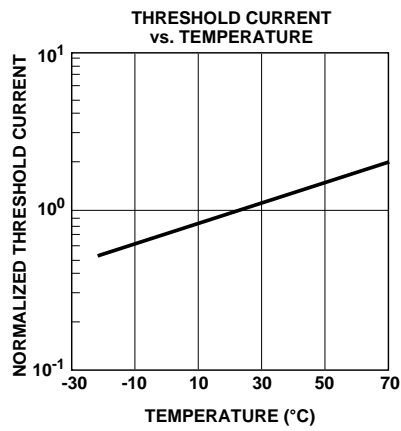
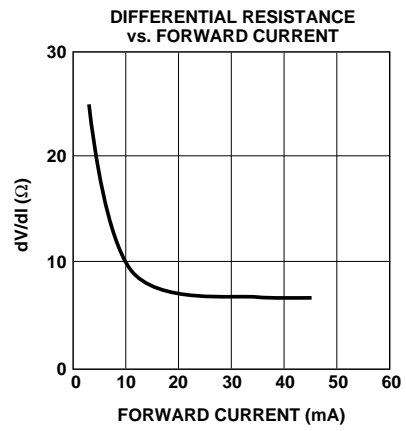
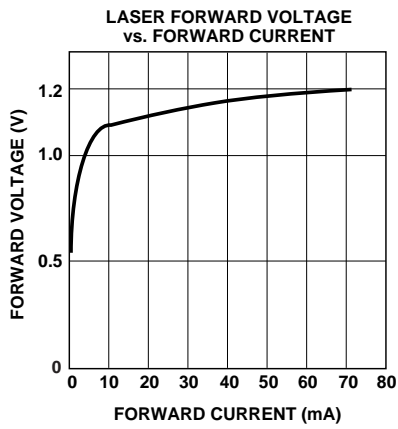

LSC3X00 Laser Diode Typical Operating Characteristics

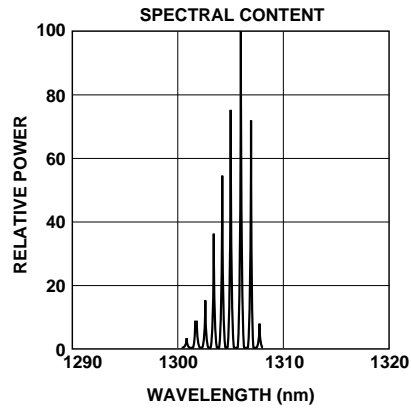
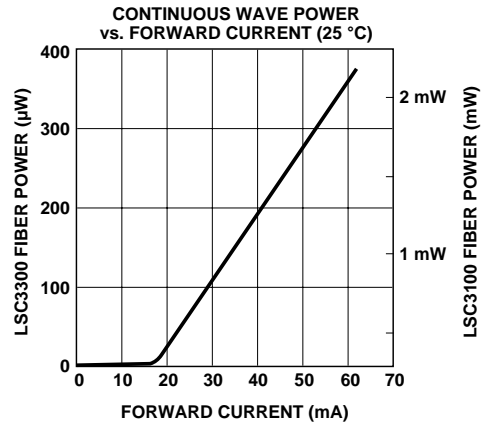
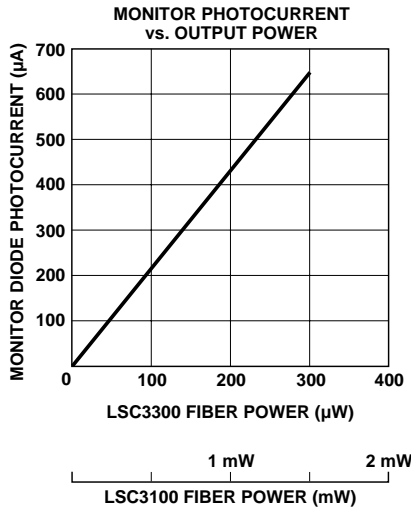

Absolute Maximum Ratings

Absolute maximum limits mean that no catastrophic damage will occur if the product is subjected to these ratings for short periods, provided each limiting parameter is in isolation and all other parameters have values within the performance specification. It should not be assumed that limiting values of more than one parameter can be applied to the product at the same time.

Parameter	Symbol	Conditions	Limits		Units
			Min.	Max.	
Laser Forward Current	If	DC	-	150	mA
Laser Reverse Current	Ir	DC	-	100	μA
Laser Reverse Voltage	Vlr	DC	-	2	V
Photodiode Reverse Voltage	Vr	DC	-	10	V
Photodiode Forward Current	Ipf	DC	-	1	mA
Operating Temperature	Tc	Pf min.	-40	+85	°C
Storage Temperature	Ts		-40	+85	°C
Relative Humidity	RH		0.0	non-condensing	%RH
Fiber Pull Strength			-	10	N
Mechanical Shock		Mil Std 883D, Method 2002, Condition B			
Vibration		Mil Std 883D, Method 2007, Condition A			

Performance Specifications

Parameter	Symbol	Conditions	LSC3300		LSC3100		Units
			Min.	Max.	Min.	Max.	
LASER		CW, Tc = 25°C, Pf = Pf min. unless otherwise stated					
Threshold Current	Ith		5	35	5	35	mA
Peak Optical Output Power	Pf		100	-	1000	-	μW
Optical Output Power	Pth	Pth = Pf @ Ith -2 mA	-	10	-	50	μW
Slope Efficiency	η		4	16	40	100	μW/mA
Forward Voltage	Vf		-	1.8	-	1.8	V
Differential Resistance	Rd	dV/dI	-	10	-	10	Ω
Centre Wavelength	λc	Note 1	1280	1330	1280	1330	nm
Ic Change with Temperature	Δλ/ΔT	Tc = -40°C to 85°C	-	0.5	-	0.5	nm/°C
Linewidth	Δλ	FWHM (2.35s)	-	5	-	5	nm
Rise Time	τr	10% to 90%: Ith to Pf = Pf min.	-	0.5	-	0.5	ns
Fall Time	τf	90% to 10%: Pf = Pf min. to Ith	-	0.5	-	0.5	ns
Small Signal Freq. Response	Bw	Pf = Pf min., ± 3 dB	1.0	-	1.0	-	GHz

Note:

1. Modulated measurement available.

If the specific performance you require is not met by the above parameters, please contact Hewlett-Packard as the submodule designs allows customization of performance to meet your needs.

Performance Specifications (cont'd.)

Parameter	Symbol	Test Conditions	LSC3300		LSC3100		Units
			Min.	Max.	Min.	Max.	
MONITOR PHOTODIODE		Tc = 25°C, Vr = -5 V, (Note 2), CW, Pf = Pf min. unless otherwise stated					
Photocurrent	Im		25	800	50	800	μA
Responsivity	R		0.25	8.0	0.05	0.8	A/W
Dark Current	Id	If = 0 mA	-	20	-	20	nA
Tracking Error	ΔR	Im = Im @ (Pf = Pf min., Tc = 25°C) Tc = -40°C to +85°C	-1.5	+1.5	-2.0	+1.5	dB

Note:

2. Photodiode will also operate under zero bias conditions.

Fiber Pigtail: Tight jacketed, self-mode stripping, single mode fiber

Parameter	Minimum	Maximum	Units
Length	1.0	-	m
Spot Size (Mode Radius)	4.5	5.5	μm
Cladding Diameter	122	128	μm
Core/Cladding Concentricity	-	1.0	μm
Secondary Jacket Diameter	0.8	1.0	mm
Effective Cutoff Wavelength	1150	1240	nm

Hewlett-Packard can offer a ruggedized fiber pigtail for this product range if extreme mechanical strength is required. The pigtail length can be customized to your specific length, with a connector, to a tolerance of ±25 mm.

Ordering Information

LSC3X00 - XX

Connectors:
FP = FC/PC Polish
ST = ST®
BI = Biconic
SA = SMA
SC = SC
DN = DIN
SF = Super Polish FC/PC

Power Range:
1 = 1 mW minimum
3 = 100 μ W minimum

CDRH Certification

Hewlett-Packard Ltd
Whitehouse Road
Ipswich, Suffolk IP1 5PB
England

Manufactured: ____ Serial No. ____
Model No. _____

This product conforms to the applicable requirements of 21 CFR 1040 at the date of manufacture.

Laser Warning

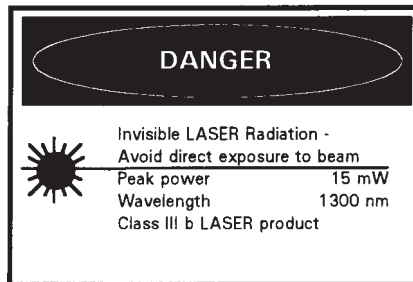

ST® is a Registered Trademark of AT&T.