

Automotive Series Serial EEPROMs

125°C SPI BUS ICs

BR25□□□□Family



BR25H□□□-WC series

No.10001EDT01

●Description

BR25H□□□-WC series is a serial EEPROM of SPI BUS interface method.

●Features

- 1) High speed clock action up to 5MHz (Max.)
- 2) Wait function by HOLDB terminal.
- 3) Part or whole of memory arrays settable as read only memory area by program.
- 4) 2.5~5.5V single power source action most suitable for battery use.
- 5) Page write mode useful for initial value write at factory shipment.
- 6) Highly reliable connection by Au pad and Au wire.
- 7) For SPI bus interface (CPOL, CPHA)=(0, 0), (1, 1)
- 8) Auto erase and auto end function at data rewrite.
- 9) Low current consumption
 At write action (5V) : 1.5mA (Typ.)
 At read action (5V) : 1.0mA (Typ.)
 At standby action (5V) : 0.1μA (Typ.)
- 10) Address auto increment function at read action
- 11) Write mistake prevention function
 Write prohibition at power on.
 Write prohibition by command code (WRDI).
 Write prohibition by WPB pin.
 Write prohibition block setting by status registers (BP1, BP0)
 Write mistake prevention function at low voltage.
- 12) SOP8, SOP-J8, TSSOP-B8 Package
- 13) Data at shipment Memory array: FFh, status register WPEN, BP1, BP0 : 0
- 14) Data kept for 40 years.
- 15) Data rewrite up to 1,000,000times.

●Page write

Number of pages	16 Byte	32 Byte
Product number	BR25H010-WC BR25H020-WC BR25H040-WC	BR25H080-WC BR25H160-WC BR25H320-WC

●BR25H series

Capacity	Bit format	Type	Power source voltage	SOP8	SOP-J8	TSSOP-B8
1Kbit	128×8	BR25H010-WC	2.5~5.5V	●	●	
2Kbit	256×8	BR25H020-WC	2.5~5.5V	●	●	
4Kbit	512×8	BR25H040-WC	2.5~5.5V	●	●	
8Kbit	1K×8	BR25H080-WC	2.5~5.5V	●	●	●
16Kbit	2K×8	BR25H160-WC	2.5~5.5V	●	●	●
32Kbit	4K×8	BR25H320-WC	2.5~5.5V	●	●	

●Absolute maximum ratings (Ta=25°C)

Parameter	Symbol	Limits	Unit
Impressed voltage	VCC	-0.3~+6.5	V
Permissible dissipation	Pd	560(SOP8) ^{*1}	mW
		560(SOP-J8) ^{*2}	
		410(TSSOP-B8) ^{*3}	
Storage temperature range	Tstg	-65~+150	°C
Operating temperature range	Topr	-40~+125	°C
Terminal voltage	-	-0.3~VCC+0.3	V

· When using at Ta=25°C or higher, 4.5mW (*1,*2), 3.3mW(*3) to be reduced per 1°C

●Memory cell characteristics (VCC=2.5V~5.5V)

Parameter	Limits			Unit	Condition
	Min.	Typ.	Max.		
Number of data rewrite times ^{*1}	1,000,000	-	-	Times	Ta≤85°C
	500,000	-	-	Times	Ta≤105°C
	300,000	-	-	Times	Ta≤125°C
Data hold years ^{*1}	40	-	-	Years	Ta≤25°C
	20	-	-	Years	Ta≤85°C

*1:Not 100% TESTED

●Recommended action conditions

Parameter	Symbol	Limits	Unit
Power source voltage	VCC	2.5~5.5	V
Input voltage	Vin	0~VCC	

●Input / output capacity (Ta=25°C, frequency=5MHz)

Parameter	Symbol	Conditions	Min	Max	Unit
Input capacity ^{*1}	C _{IN}	V _{IN} =GND	-	8	pF
Output capacity ^{*1}	C _{OUT}	V _{OUT} =GND	-	8	

*1: Not 100% TESTED

●Electrical characteristics (Unless otherwise specified, Ta=-40~+125°C, VCC=2.5~5.5V)

Parameter	Symbol	Limits			Unit	Conditions
		Min.	Typ.	Max.		
"H" input voltage	VIH	0.7xVCC	-	VCC+0.3	V	2.5≤VCC≤5.5V
"L" input voltage	VIL	-0.3	-	0.3xVCC	V	2.5≤VCC≤5.5V
"L" output voltage	VOL	0	-	0.4	V	IOL=2.1mA
"H" output voltage	VOH	VCC-0.5	-	VCC	V	IOH=-0.4mA
Input leak current	ILI	-10	-	10	μA	VIN=0~VCC
Output leak current	ILO	-10	-	10	μA	VOUT=0~VCC, CSB=VCC
Current consumption at write action	ICC1	-	-	2.0	mA	VCC=2.5V, fSCK=5MHz, tE/W=5ms VIH/VIL=0.9VCC/0.1VCC, SO=OPEN Byte write, Page write Write status register
	ICC2	-	-	3.0	mA	VCC=5.5V, fSCK=5MHz, tE/W=5ms VIH/VIL=0.9VCC/0.1VCC, SO=OPEN Byte write, Page write Write status register
Current consumption at read action	ICC3	-	-	1.5	mA	VCC=2.5V, fSCK=5MHz VIH/VIL=0.9VCC/0.1VCC, SO=OPEN Read, Read status register
	ICC4	-	-	2.0	mA	VCC=5.5V, fSCK=5MHz VIH/VIL=0.9VCC/0.1VCC, SO=OPEN Read, Read status register
Standby current	ISB	-	-	10	μA	VCC=5.5V CSB=HOLDB=WPB=VCC, SCK=SI=VCC or =GND, SO=OPEN

*Radiation resistance design is not made

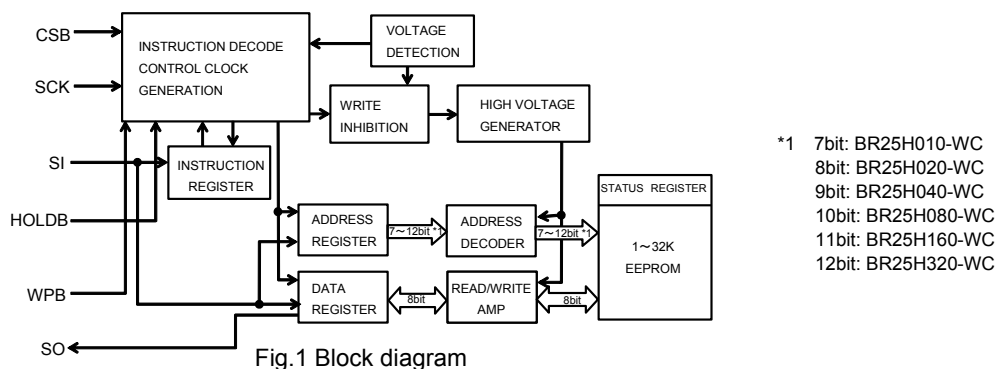
●Block diagram

*1 7bit: BR25H010-WC
8bit: BR25H020-WC
9bit: BR25H040-WC
10bit: BR25H080-WC
11bit: BR25H160-WC
12bit: BR25H320-WC

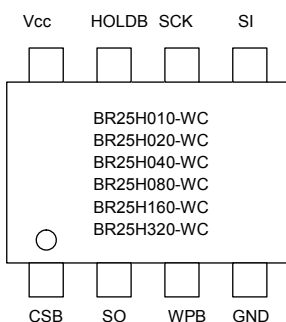
●Pin assignment and description

Terminal name	Input/Output	Function
VCC	-	Power source to be connected
GND	-	All input / output reference voltage, 0V
CSB	Input	Chip select input
SCK	Input	Serial clock input
SI	Input	Start bit, ope code, address, and serial data input
SO	Output	Serial data output
HOLDB	Input	Hold input Command communications may be suspended temporarily (HOLD status)
WPB	Input	Write protect input Write command is prohibited *1 Write status register command is prohibited.

*1:BR25H010/020/040-WC

● Operating timing characteristics

(Ta=-40~+125°C, unless otherwise specified, load capacity CL1=100pF)

Parameter	Symbol	2.5≤VCC≤5.5V			Unit
		Min.	Typ.	Max.	
SCK frequency	fSCK	-	-	5	MHz
SCK high time	tSCKWH	85	-	-	ns
SCK low time	tSCKWL	85	-	-	ns
CSB high time	tCS	85	-	-	ns
CSB setup time	tCSS	90	-	-	ns
CSB hold time	tCSH	85	-	-	ns
SCK setup time	tSCKS	90	-	-	ns
SCK hold time	tSCKH	90	-	-	ns
SI setup time	tDIS	20	-	-	ns
SI hold time	tDIH	30	-	-	ns
Data output delay time1	tPD1	-	-	70	ns
Data output delay time2 (CL2=30pF)	tPD2	-	-	55	ns
Output hold time	tOH	0	-	-	ns
Output disable time	tOZ	-	-	100	ns
HOLDB setting setup time	tHFS	0	-	-	ns
HOLDB setting hold time	tHFH	40	-	-	ns
HOLDB release setup time	tHRS	0	-	-	ns
HOLDB release hold time	tHRH	70	-	-	ns
Time from HOLDB to output High-Z	tHOZ	-	-	100	ns
Time from HOLDB To output change	tHPD	-	-	70	ns
SCK rise time*1	tRC	-	-	1	μs
SCK fall time*1	tFC	-	-	1	μs
OUTPUT rise time*1	tRO	-	-	50	ns
OUTPUT fall time*1	tFO	-	-	50	ns
Write time	tE/W	-	-	5	ms

*1 NOT 100% TESTED

● Sync data input / output timing

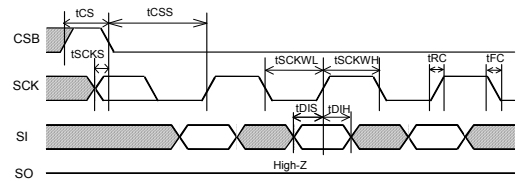

Fig.3 Input timing

SI is taken into IC inside in sync with data rise edge of SCK. Input address and data from the most significant bit MSB.

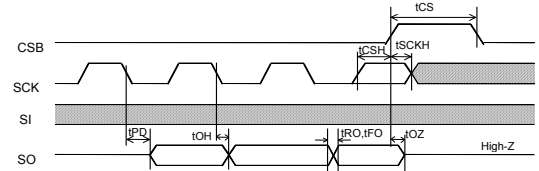

Fig.4 Input / Output timing

SO is output in sync with data fall edge of SCK. Data is output from the most significant bit MSB.

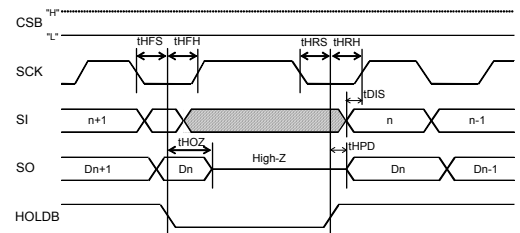

Fig.5 HOLD timing

● AC measurement conditions

Parameter	Symbol	Limits			Unit
		Min.	Typ.	Max.	
Load capacity 1	CL1	-	-	100	pF
Load capacity 2	CL2	-	-	30	pF
Input rise time	-	-	-	50	ns
Input fall time	-	-	-	50	ns
Input voltage	-	0.2VCC/0.8VCC			V
Input / Output judgment voltage	-	0.3VCC/0.7VCC			V

●Characteristic data (The following characteristic data are Typ. Value.)

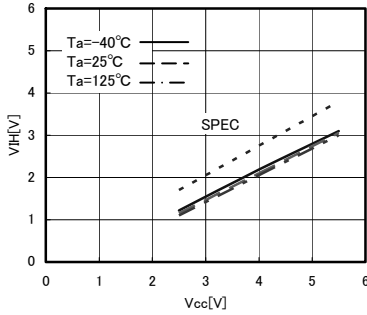

Fig.6 "H" input voltage $V_{IH}(CSB,SCK,SI,HOLDB,WPB)$

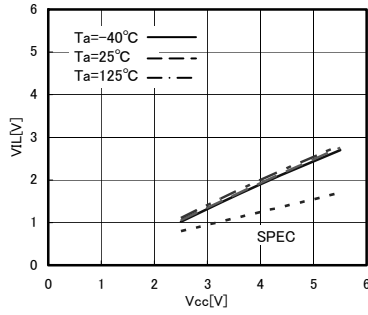

Fig.7 "L" input voltage $V_{IL}(CSB,SCK,SI,HOLDB,WPB)$

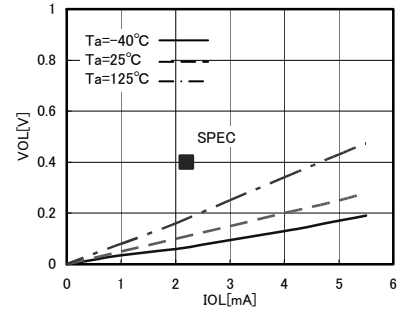

Fig.8 "L" output voltage $V_{OL}(IOL)(V_{CC}=2.5V)$

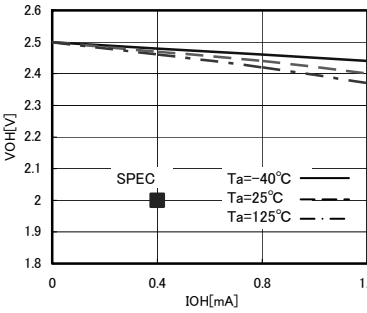

Fig.9 "H" output voltage $V_{OH}(I_{OH})(V_{CC}=2.5V)$

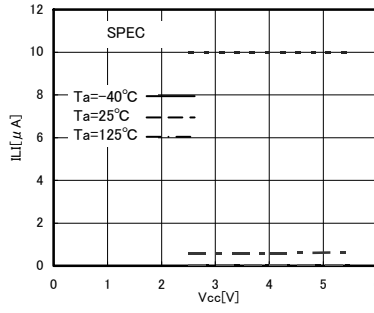

Fig.10 Input leak current $I_{IL}(CSB,SCK,SI,HOLDB,WPB)$

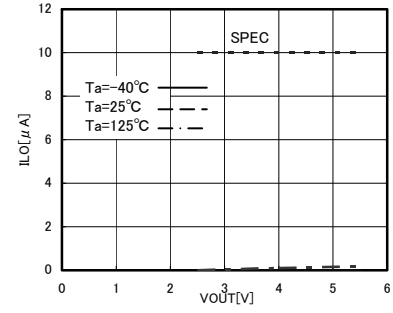

Fig.11 Output leak current $I_{LO}(SO)(V_{CC}=5.5V)$

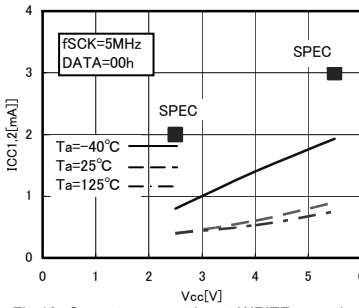

Fig.12 Current consumption at WRITE operation $ICC_{1,2}$

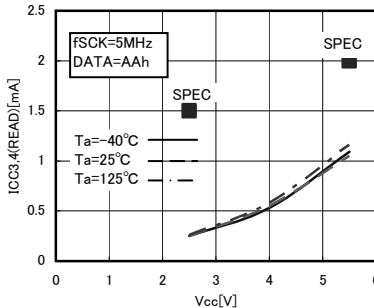

Fig.13 Consumption Current at READ operation $ICC_{3,4}$

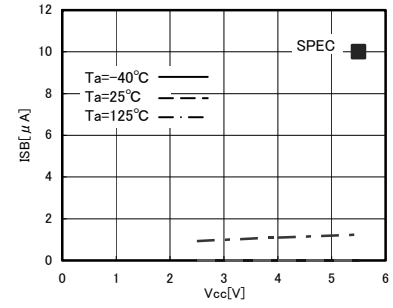

Fig.14 Consumption current at standby operation ISB

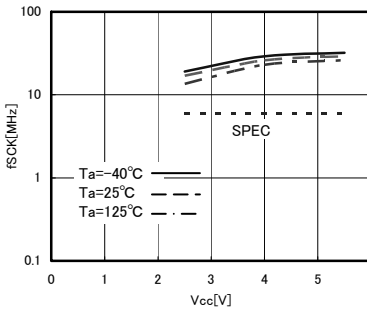

Fig.15 SCK frequency f_{SCK}

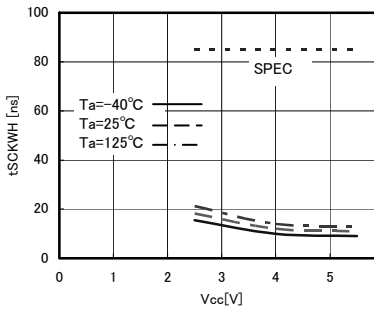

Fig.16 SCK high time t_{SCKWH}

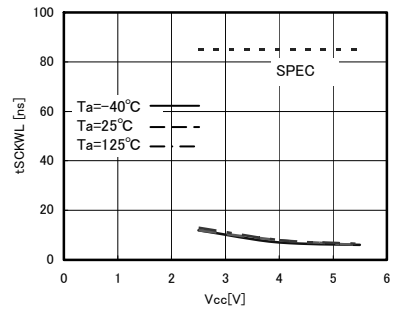

Fig.17 SCK low time t_{SCKWL}

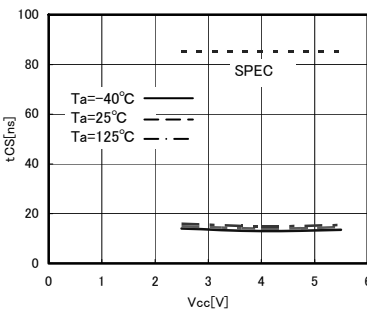

Fig.18 CSB high time t_{CS}

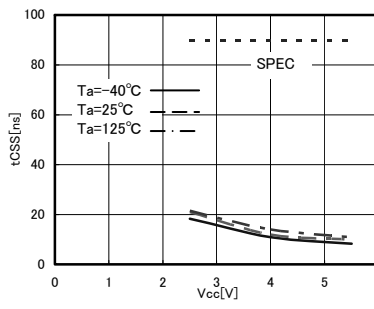

Fig.19 CSB setup time t_{CSS}

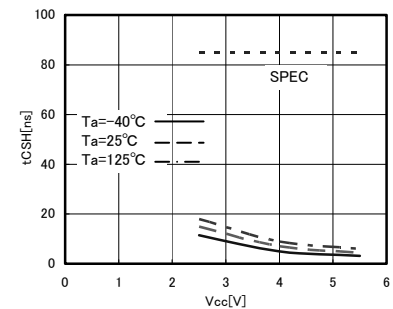

Fig.20 CSB hold time t_{CSH}

●Characteristic data (The following characteristic data are Typ. Value.)

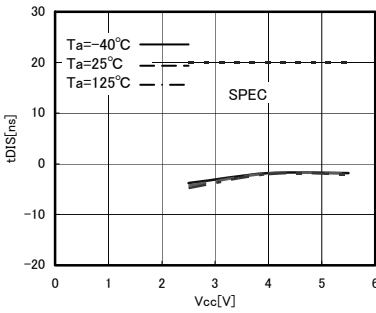

Fig.21 SI setup time tDIS

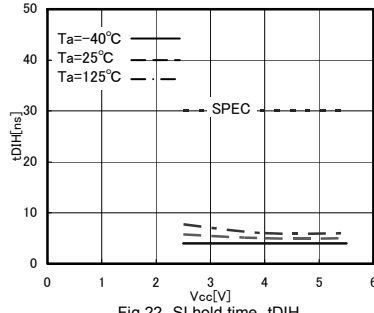

Fig.22 SI hold time tDIH

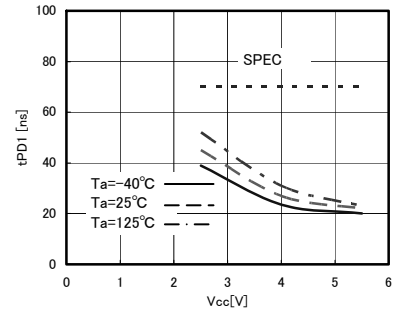

Fig.23 Data output delay time tPD1(CL=100pF)

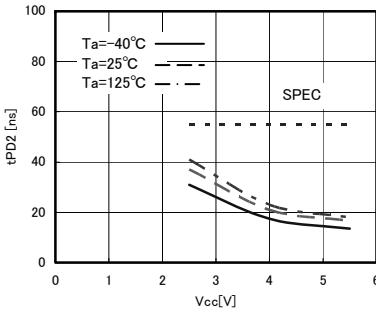

Fig.24 Data output delay time tPD2(CL=30pF)

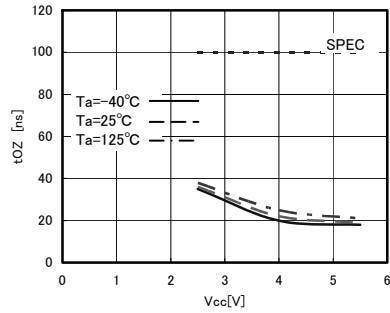

Fig.25 Output disable time tOZ

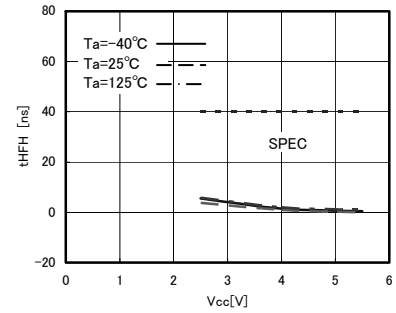

Fig.26 HOLDB setting hold time tHFH

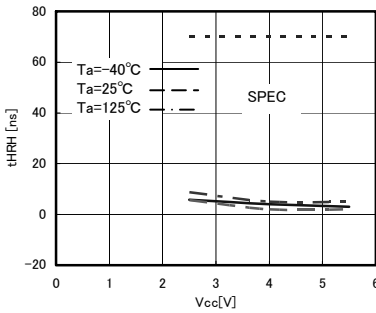

Fig.27 HOLDB release hold time tHRH

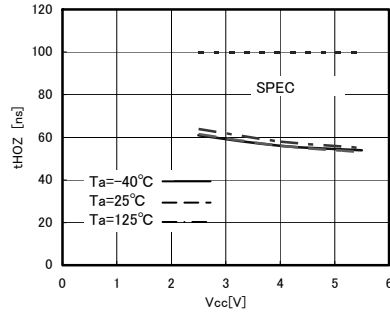

Fig.28 Time from HOLDB to output High-Z tHOZ

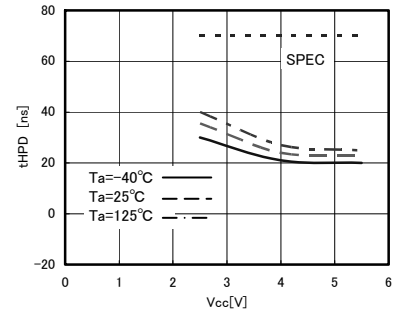

Fig.29 Time from HOLDB to output change tHPD

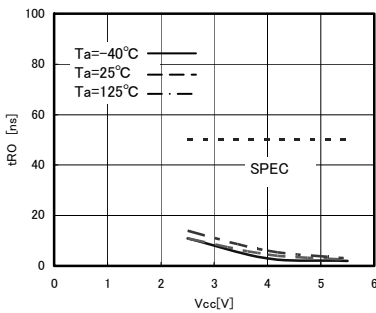

Fig.30 Output rise time tRO

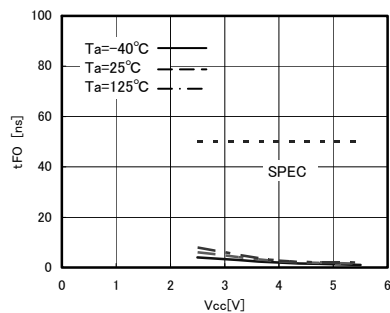

Fig.31 Output fall time tFO

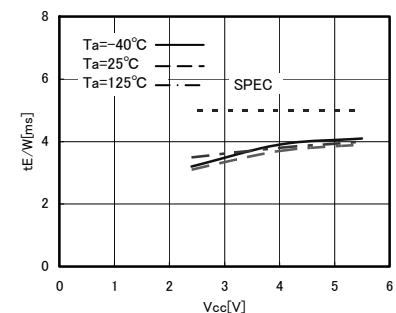

Fig.32 Write cycle time tE/W

●Features

○Status registers

This IC has status registers. The status registers are of 8 bits and express the following parameters.

BP0 and BP1 can be set by write status register command. These 2 bits are memorized into the EEPROM, therefore are valid even when power source is turned off.

Rewrite characteristics and data hold time are same as characteristics of the EEPROM.

WEN can be set by write enable command and write disable command. WEN becomes write disable status when power source is turned off. \bar{R}/B is for write confirmation, therefore cannot be set externally.

The value of status register can be read by read status command.

●Status registers

Product number	bit 7	bit 6	bit 5	bit 4	bit 3	bit 2	bit 1	bit 0
BR25H010-WC	1	1	1	1	BP1	BP0	WEN	\bar{R}/B
BR25H020-WC								
BR25H040-WC								
BR25H080-WC	WPEN	0	0	0	BP1	BP0	WEN	\bar{R}/B
BR25H160-WC								
BR25H320-WC								

bit	Memory location	Function	Contents
WPEN	EEPROM	WPB pin enable / disable designation bit WPEN=0=invalid WPEN=1=valid	This enables / disables the functions of WPB pin.
BP1 BP0	EEPROM	EEPROM write disable block designation bit	This designates the write disable area of EEPROM. Write designation areas of product numbers are shown below.
WEN	Register	Write and write status register write enable / disable status confirmation bit WEN=0=prohibited WEN=1=permitted	
\bar{R}/B	Register	Write cycle status (READY / BUSY) status confirmation bit $\bar{R}/B=0=READY$ $\bar{R}/B=1=BUSY$	

●Write disable block setting

BP1	BP0	Write disable block					
		BR25H010-WC	BR25H020-WC	BR25H040-WC	BR25H080-WC	BR25H160-WC	BR25H320-WC
0	0	None	None	None	None	None	None
0	1	60h-7Fh	C0h-FFh	180h-1FFh	300h-3FFh	600h-7FFh	C00h-FFFh
1	0	40h-7Fh	80h-FFh	100h-1FFh	200h-3FFh	400h-7FFh	800h-FFFh
1	1	00h-7Fh	00h-FFh	000h-1FFh	000h-3FFh	000h-7FFh	000h-FFFh

○WPB pin

By setting WPB=LOW, write command is prohibited. As for BR25H080/160/320-WC, only when WPEN bit is set "1", the WPB pin functions become valid. And the write command to be disabled at this moment is WRSR. As for BR25H010/020/040-WC, both WRITE and WRSR commands are prohibited.

However, when write cycle is in execution, no interruption can be made.

Product number	WRSR	WRITE
BR25H010-WC	Prohibition possible	Prohibition possible
BR25H020-WC		
BR25H040-WC		
BR25H080-WC	Prohibition possible but WPEN bit "1"	Prohibition impossible
BR25H160-WC		
BR25H320-WC		

○HOLDB pin

By HOLDB pin, data transfer can be interrupted. When SCK="0", by making HOLDB from "1" into "0", data transfer to EEPROM is interrupted. When SCK = "0", by making HOLDB from "0" into "1", data transfer is restarted.

●Command mode

Command		Contents	Ope code					
			BR25H010-WC BR25H020-WC		BR25H040-WC		BR25H080-WC BR25H160-WC BR25H320-WC	
WREN	Write enable	Write enable command	0000	*110	0000	*110	0000	0110
WRDI	Write disable	Write disable command	0000	*100	0000	*100	0000	0100
READ	Read	Read command	0000	*011	0000	A8011	0000	0011
WRITE	Write	Write command	0000	*010	0000	A8010	0000	0010
RDSR	Read status register	Status register read command	0000	*101	0000	*101	0000	0101
WRSR	Write status register	Status register write command	0000	*001	0000	*001	0000	0001

*=Don't Care Bit.

●Timing chart

1. Write enable (WREN) / disable (WRDI) cycle

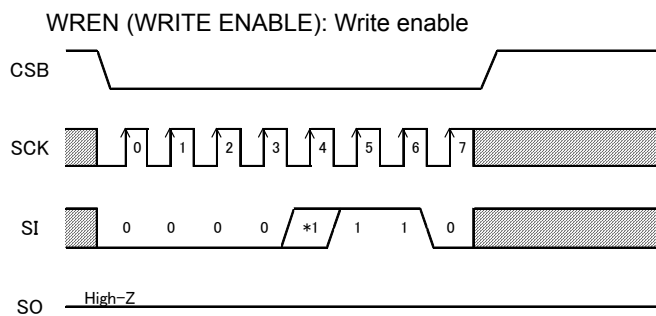

Fig.33 Write enable command

*1 BR25H010/020/040-WC= Don't care
BR25H080/160/320-WC= "0" input

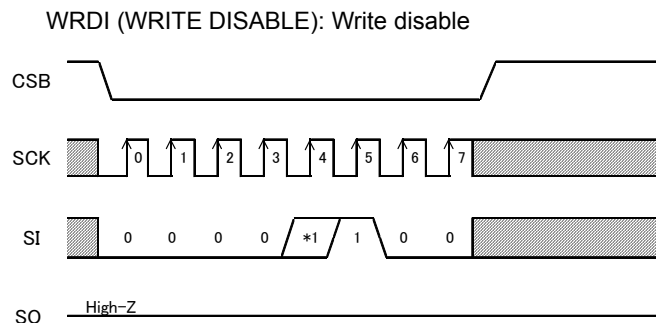

Fig.34 Write disable

*1 BR25H010/020/040-WC= Don't care
BR25H080/160/320-WC= "0" input

○This IC has write enable status and write disable status. It is set to write enable status by write enable command, and it is set to write disable status by write disable command. As for these commands, set CSB LOW, and then input the respective ope codes. The respective commands accept command at the 7-th clock rise. Even with input over 7 clocks, command becomes valid.

When to carry out write and write status register command, it is necessary to set write enable status by the write enable command. If write or write status register command is input in the write disable status, commands are cancelled. And even in the write enable status, once write and write status register command is executed, it gets in the write disable status. After power on, this IC is in write disable status.

2. Read command (READ)

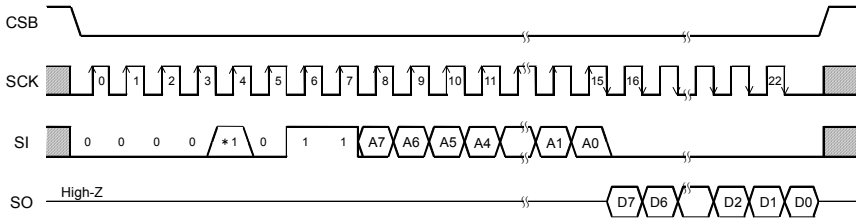

Product number	Address length
BR25H010-WC	A6-A0
BR25H020-WC	A7-A0
BR25H040-WC	A8-A0

Fig.35 Read command (BR25H010/020/040-WC)

*1 BR25H010/020-WC=Don't care
BR25H040-WC=A8

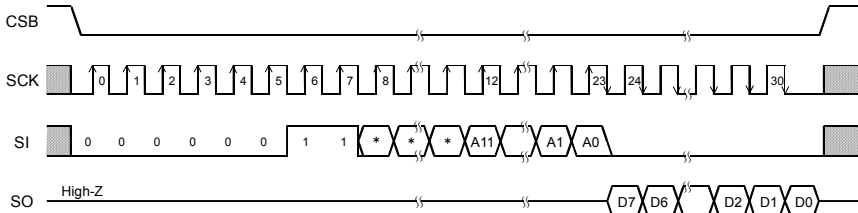

Product number	Address length
BR25H080-WC	A9-A0
BR25H160-WC	A10-A0
BR25H320-WC	A11-A0

Fig.36 Read command (BR25H080/160/320-WC)

*=Don't Care
*1 BR25H010/020/040-WC=15 clocks
BR25H080/160/320-WC=23 clocks

By read command, data of EEPROM can be read. As for this command, set CSB LOW, then input address after read ope code. EEPROM starts data output of the designated address. Data output is started from SCK fall of 15/23¹ clock, and from D7 to D0 sequentially. This IC has increment read function. After output of data for 1 byte (8bits), by continuing input of SCK, data of the next address can be read. Increment read can read all the addresses of EEPROM. After reading data of the most significant address, by continuing increment read, data of the most insignificant address is read.

3. Write command (WRITE)

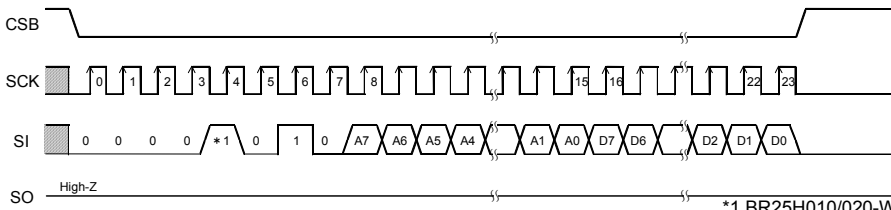

Product number	Address length
BR25H010-WC	A6-A0
BR25H020-WC	A7-A0
BR25H040-WC	A8-A0

Fig.37 Write command (BR25H010/020/040-WC)

*1 BR25H010/020-WC=Don't care
BR25H040-WC=A8

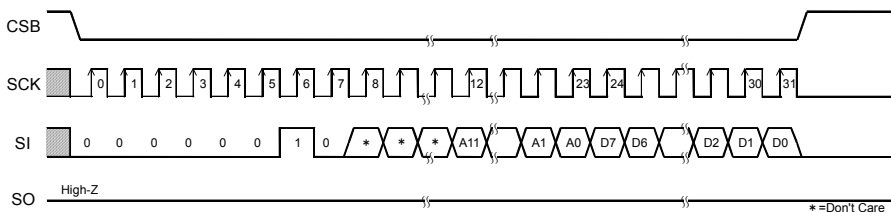

Product number	Address length
BR25H080-WC	A9-A0
BR25H160-WC	A10-A0
BR25H320-WC	A11-A0

Fig.38 Write command (BR25H080/160/320-WC)

*=Don't Care

By write command, data of EEPROM can be written. As for this command, set CSB LOW, then input address and data after write ope code. Then, by making CSB HIGH, the EEPROM starts writing. The write time of EEPROM requires time of tE/W (Max 5ms). During tE/W, other than status read command is not accepted. Start CSB after taking the last data (D0), and before the next SCK clock starts. At other timing, write command is not executed, and this write command is cancelled. This IC has page write function, and after input of data for 1 byte (8 bits), by continuing data input without starting CSB, data up to 16/32¹ bytes can be written for one tE/W. In page write, the insignificant 4/5² bit of the designated address is incremented internally at every time when data of 1 byte is input and data is written to respective addresses. When data of the maximum bytes or higher is input, address rolls over, and previously input data is overwritten.

*1 BR25H010/020/040-WC=16 bytes at maximum
BR25H080/160/320-WC=32 bytes at maximum
*2 BR25H010/020/040-WC=Insignificant 4 bits
BR25H080/160/320-WC=Insignificant 5 bits

4. Status register write / read command

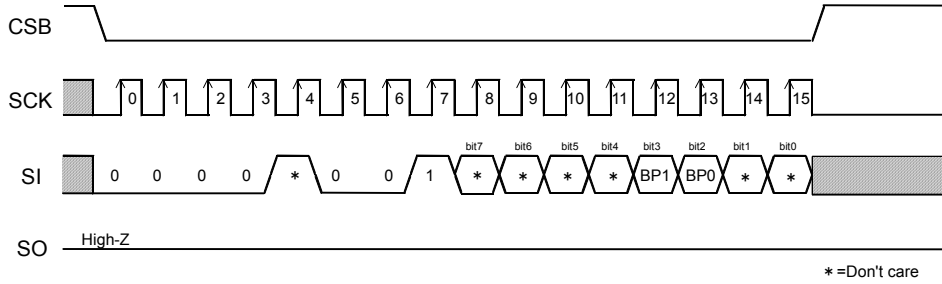

Fig.39 Status register write command (BR25H010/020/040-WC)

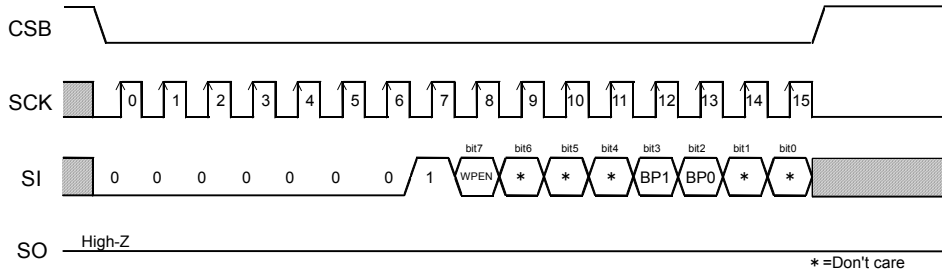

Fig.40 Status register write command (BR25H080/160/320-WC)

Write status register command can write status register data. The data can be written by this command are 2 bits^{*1}, that is, BP1 (bit3) and BP0 (bit2) among 8 bits of status register. By BP1 and BP0, write disable block of EEPROM can be set. As for this command, set CSB LOW, and input ope code of write status register, and input data. Then, by making CSB HIGH, EEPROM starts writing. Write time requires time of tE/W as same as write. As for CSB rise, start CSB after taking the last data bit (bit0), and before the next SCK clock starts. At other timing, command is cancelled. Write disable block is determined by BP1 and BP0, and the block can be selected from 1/4 of memory array, 1/2, and entire memory array. (Refer to the write disable block setting table.)

To the write disabled block, write cannot be made, and only read can be made.

^{*1} 3bits including BR25H080/160/320-WC WPEN (bit7)

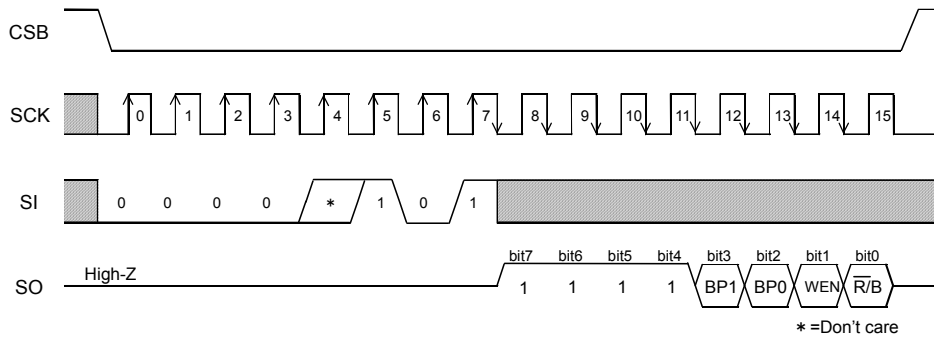

Fig.41 Status register read command (BR25H010/020/040-WC)

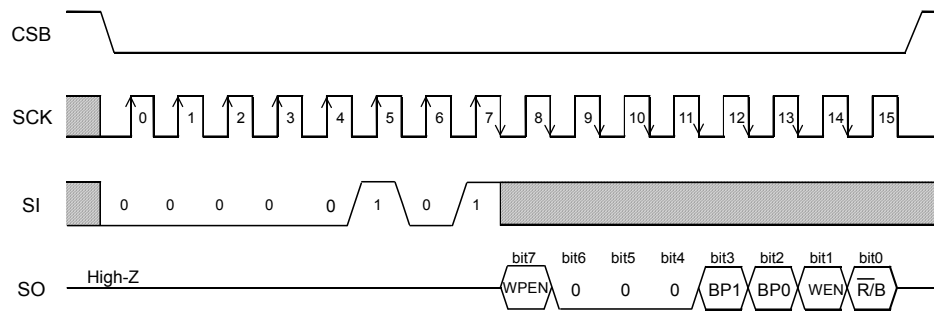

Fig.42 Status register read command (BR25H080/160/320-WC)

●At standby

○Current at standby

Set CSB "H", and be sure to set SCK, SI, WPB, HOLDB input "L" or "H". Do not input intermediate electric potential.

○Timing

As shown in Fig.43, at standby, when SCK is "H", even if CSB is fallen, SI status is not read at fall edge. SI status is read at SCK rise edge after fall of CSB. At standby and at power ON/OFF, set CSB "H" status.

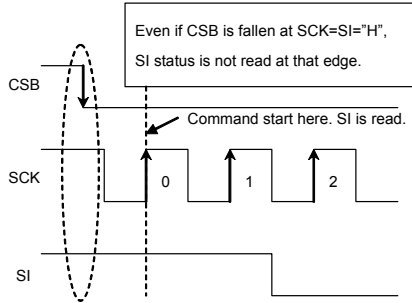

Fig.43 Operating timing

●WPB cancel valid area

WPB is normally fixed to "H" or "L" for use, but when WPB is controlled so as to cancel write status register command and write command, pay attention to the following WPB valid timing.

While write or write status register command is executed, by setting WPB = "L" in cancel valid area, command can be cancelled. The area from command ope code before CSB rise at internal automatic write start becomes the cancel valid area. However, once write is started, any input cannot be cancelled. WPB input becomes Don't Care, and cancellation becomes invalid.

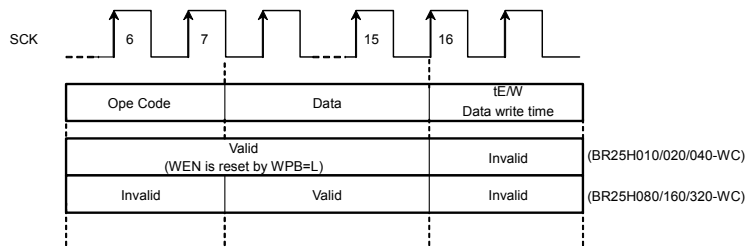

Fig.44 WPB valid timing (WRSR)

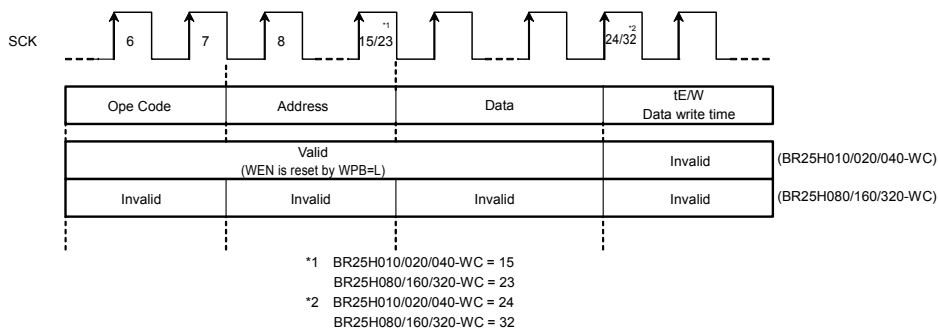

Fig.45 WPB valid timing (WRITE)

●HOLDB pin

By HOLDB pin, command communication can be stopped temporarily (HOLD status). The HOLDB pin carries out command communications normally when it is HIGH. To get in HOLD status, at command communication, when SCK=LOW, set the HOLDB pin LOW. At HOLD status, SCK and SI become Don't Care, and SO becomes high impedance (High-Z). To release the HOLD status, set the HOLDB pin HIGH when SCK=LOW. After that, communication can be restarted from the point before the HOLD status. For example, when HOLD status is made after A5 address input at read, after release of HOLD status, by starting A4 address input, read can be restarted. When in HOLD status, leave CSB LOW. When it is set CSB=HIGH in HOLD status, the IC is reset, therefore communication after that cannot be restarted.

●Method to cancel each command

○READ

- Method to cancel : cancel by CSB = "H"

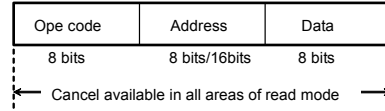

Fig.46 READ cancel valid timing

○RDSR

- Method to cancel : cancel by CSB = "H"

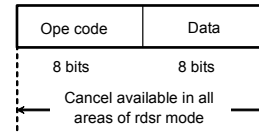

Fig.47 RDSR cancel valid timing

○WRITE、PAGE WRITE

- a : Ope code, address input area.
Cancellation is available by CSB="H"
- b : Data input area (D7~D1 input area)
Cancellation is available by CSB="H"
- c : Data input area (D0 area)
When CSB is started, write starts.
After CSB rise, cancellation cannot be made by any means.
- d : tE/W area.
Cancellation is available by CSB = "H". However, when write starts (CSB is started) in the area c, cancellation cannot be made by any means. And by inputting on SCK clock, cancellation cannot be made. In page write mode, there is write enable area at every 8 clocks.

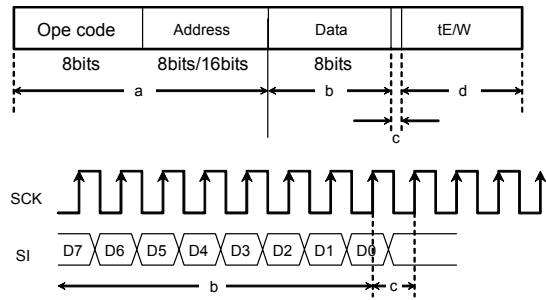

Fig.48 WRITE cancel valid timing

- Note 1) If VCC is made OFF during write execution, designated address data is not guaranteed, therefore write it once again.
- Note 2) If CSB is started at the same timing as that of the SCK rise, write execution / cancel becomes unstable, therefore, it is recommended to fall in SCK = "L" area. As for SCK rise, assure timing of tCSS / tCSH or higher.

○WRSR

- a : From ope code to 15 rise.
Cancel by CSB = "H".
- b : From 15 clock rise to 16 clock rise (write enable area).
When CSB is started, write starts.
After CSB rise, cancellation cannot be made by any means.
- c : After 16 clock rise.
Cancel by CSB="H". However, when write starts (CSB is started) in the area b, cancellation cannot be made by any means.
And, by inputting on SCK clock, cancellation cannot be made.

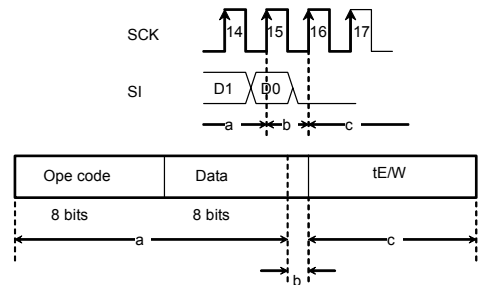

Fig.49 WRSR cancel valid timing

- Note 1) If VCC is made OFF during write execution, designated address data is not guaranteed, therefore write it once again
- Note 2) If CSB is started at the same timing as that of the SCK rise, write execution / cancel becomes unstable, therefore, it is recommended to fall in SCK = "L" area. As for SCK rise, assure timing of tCSS / tCSH or higher.

○WREN/WRDI

- a : From ope code to 7-th clock rise, cancel by CSB = "H".
- b : Cancellation is not available when CSB is started after 7-th clock.

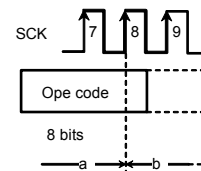

Fig.50 WREN/WRDI cancel valid timing

●High speed operation

In order to realize stable high speed operations, pay attention to the following input / output pin conditions.

○Input pin pull up, pull down resistance

When to attach pull up, pull down resistance to EEPROM input pin, select an appropriate value for the microcontroller VOL, IOL from VIL characteristics of this IC.

○Pull up resistance

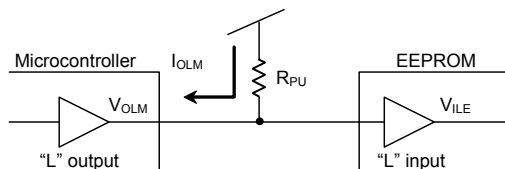

Fig.51 Pull up resistance

$$R_{PU} \geq \frac{V_{CC} - V_{OLM}}{I_{OLM}} \quad \dots \textcircled{1}$$

$$V_{OLM} \leq V_{ILE} \quad \dots \textcircled{2}$$

Example) When $V_{CC}=5V$, $V_{ILE}=1.5V$, $V_{OLM}=0.4V$, $I_{OLM}=2mA$, from the equation ①,

$$R_{PU} \geq \frac{5 - 0.4}{2 \times 10^{-3}}$$

$$\therefore R_{PU} \geq 2.3[k\Omega]$$

With the value of R_{PU} to satisfy the above equation, V_{OLM} becomes 0.4V or lower, and with $V_{ILE} (=1.5V)$, the equation ② is also satisfied.

- V_{ILE} : EEPROM V_{IL} specifications
- V_{OLM} : Microcontroller V_{OL} specifications
- I_{OLM} : Microcontroller I_{OL} specifications

And, in order to prevent malfunction, mistake write at power ON/OFF, be sure to make CSB pull up.

○Pull down resistance

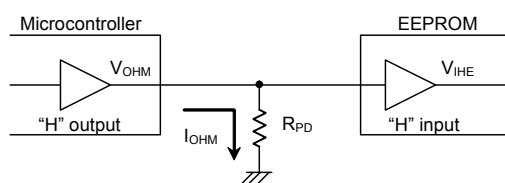

Fig.52 Pull down resistance

$$R_{PD} \geq \frac{V_{OHM}}{I_{OHM}} \quad \dots \textcircled{3}$$

$$V_{OHM} \geq V_{IHE} \quad \dots \textcircled{4}$$

Example) When $V_{CC}=5V$, $V_{OHM}=V_{CC}-0.5V$, $I_{OHM}=0.4mA$, $V_{IHE}=V_{CC} \times 0.7V$, from the equation ③,

$$R_{PD} \geq \frac{5 - 0.5}{0.4 \times 10^{-3}}$$

$$\therefore R_{PD} \geq 11.3[k\Omega]$$

Further, by amplitude V_{IHE} , V_{ILE} of signal input to EEPROM, operation speed changes. By inputting signal of amplitude of V_{CC} / GND level to input, more stable high speed operations can be realized. On the contrary, when amplitude of $0.8V_{CC} / 0.2V_{CC}$ is input, operation speed becomes slow.^{*1}

In order to realize more stable high speed operation, it is recommended to make the values of R_{PU} , R_{PD} as large as possible, and make the amplitude of signal input to EEPROM close to the amplitude of V_{CC} / GND level.

(*1 At this moment, operating timing guaranteed value is guaranteed.)

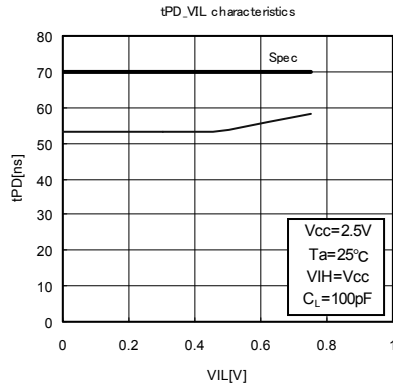

Fig.53 VIL dependency of data output delay time tPD

OSO load capacity condition

Load capacity of SO output pin affects upon delay characteristic of SO output. (Data output delay time, time from HOLDB to High-Z) In order to make output delay characteristic into higher speed, make SO load capacity small. In concrete, “Do not connect many devices to SO bus”, “Make the wire between the controller and EEPROM short”, and so forth.

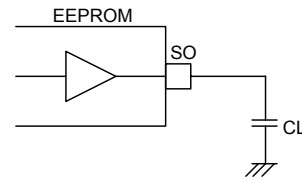
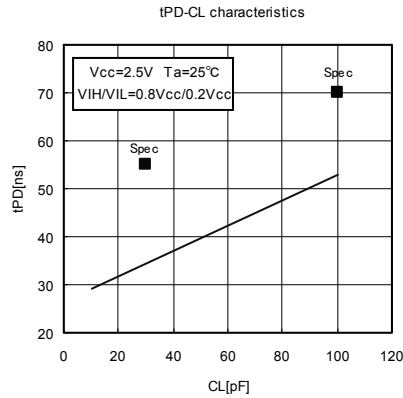

Fig.54 SO load dependency of data output delay time tPD

Other cautions

Make the wire length from the microcontroller to EEPROM input signal same length, in order to prevent setup / hold violation to EEPROM, owing to difference of wire length of each input.

- Equivalent circuit
- Output circuit

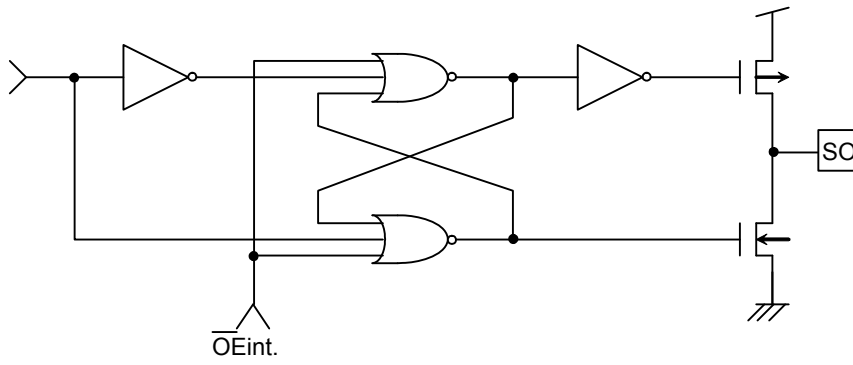

Fig.55 SO output equivalent circuit

- Input circuit

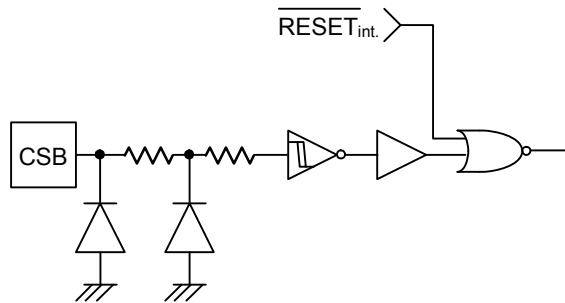

Fig.56 CSB input equivalent circuit

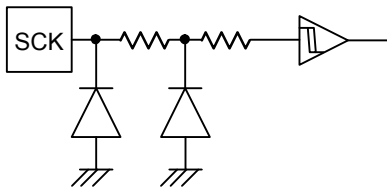

Fig.57 SCK input equivalent circuit

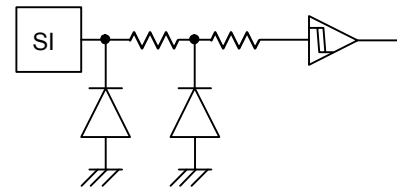

Fig.58 SI input equivalent circuit

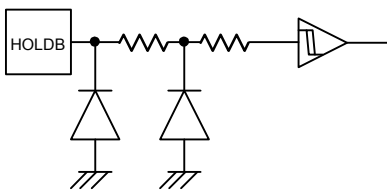

Fig.59 HOLDB input equivalent circuit

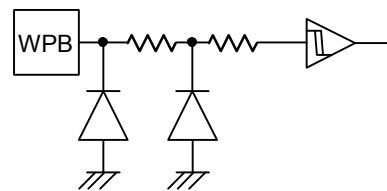

Fig.60 WPB input equivalent circuit

●Notes on power ON/OFF

○At power ON/OFF, set CSB "H" (=VCC).

When CSB is "L", this IC gets in input accept status (active). If power is turned on in this status, noises and the likes may cause malfunction, mistake write or so. To prevent these, at power ON, set CSB "H". (When CSB is in "H" status, all inputs are canceled.)

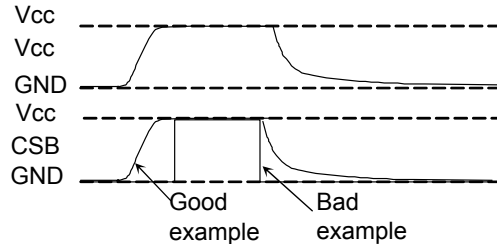

Fig.61 CSB timing at power ON/OFF

(Good example) CSB terminal is pulled up to VCC.

At power OFF, take 10ms or higher before supply. If power is turned on without observing this condition, the IC internal circuit may not be reset, which please note.

(Bad example) CSB terminal is "L" at power ON/OFF.

In this case, CSB always becomes "L" (active status), and EEPROM may have malfunction, mistake write owing to noises and the likes.

Even when CSB input is High-Z, the status becomes like this case, which please note.

○LVCC circuit

LVCC (VCC-Lockout) circuit prevents data rewrite action at low power, and prevents wrong write.

At LVCC voltage (Typ. =1.9V) or below, it prevent data rewrite.

○P.O.R. circuit

This IC has a POR (Power On Reset) circuit as mistake write countermeasure. After POR action, it gets in write disable status. The POR circuit is valid only when power is ON, and does not work when power is OFF. When power is ON, if the recommended conditions of the following t_R , t_{OFF} , and V_{bot} are not satisfied, it may become write enable status owing to noises and the likes.

Recommended conditions of t_R , t_{OFF} , V_{bot}

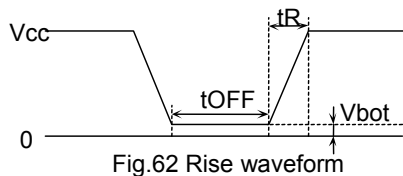

Fig.62 Rise waveform

t_R	t_{OFF}	V_{bot}
10ms or below	10ms or higher	0.3V or below
100ms or below	10ms or higher	0.2V or below

●Noise countermeasures

○VCC noise (bypass capacitor)

When noise or surge gets in the power source line, malfunction may occur, therefore, for removing these, it is recommended to attach a bypass capacitor (0.1 μ F) between IC VCC and GND. At that moment, attach it as close to IC as possible. And, it is also recommended to attach a bypass capacitor between board VCC and GND.

○SCK noise

When the rise time (tR) of SCK is long, and a certain degree or more of noise exists, malfunction may occur owing to clock bit displacement. To avoid this, a Schmitt trigger circuit is built in SCK input. The hysteresis width of this circuit is set about 0.2V, if noises exist at SCK input, set the noise amplitude 0.2Vp-p or below. And it is recommended to set the rise time (tR) of SCK 100ns or below. In the case when the rise time is 100ns or higher, take sufficient noise countermeasures. Make the clock rise, fall time as small as possible.

○WPB noise

During execution of write status register command, if there exist noises on WPB pin, mistake in recognition may occur and forcible cancellation may result, which please note. To avoid this, a Schmitt trigger circuit is built in WPB input. In the same manner, a Schmitt trigger circuit is built in CSB input, SI input and HOLDB input too.

●Note of use

(1) Described numeric values and data are design representative values, and the values are not guaranteed.

(2) We believe that application circuit examples are recommendable, however, in actual use, confirm characteristics further sufficiently. In the case of use by changing the fixed number of external parts, make your decision with sufficient margin in consideration of static characteristics and transition characteristics and fluctuations of external parts and our LSI.

(3) Absolute maximum ratings

If the absolute maximum ratings such as impressed voltage and operating temperature range and so forth are exceeded, LSI may be destructed. Do not impress voltage and temperature exceeding the absolute maximum ratings. In the case of fear exceeding the absolute maximum ratings, take physical safety countermeasures such as fuses, and see to it that conditions exceeding the absolute maximum ratings should not be impressed to LSI.

(4) GND electric potential

Set the voltage of GND terminal lowest at any action condition. Make sure that each terminal voltage is higher than that of GND terminal.

(5) Heat design

In consideration of permissible dissipation in actual use condition, carry out heat design with sufficient margin.

(6) Terminal to terminal short circuit and wrong packaging

When to package LSI onto a board, pay sufficient attention to LSI direction and displacement. Wrong packaging may destruct LSI. And in the case of short circuit between LSI terminals and terminals and power source, terminal and GND owing to foreign matter, LSI may be destructed.

(7) Use in a strong electromagnetic field may cause malfunction, therefore, evaluate design sufficiently.

●Ordering part number

B	R	2	5	H	0	1	0	F	-	W	C	E	2
Rohm type		BUS type 25 : SPI		Operating temperature H: -40°C~+125°C	Capacity 010= 1K 020= 2K 040= 4K 080= 8K 160=16K 320=32K			Package type F : SOP8 FJ : SOP-J8 FVT :TSSOP-B8		Double cell		Packaging and forming specification E2: Embossed tape and reel	

SOP-J8

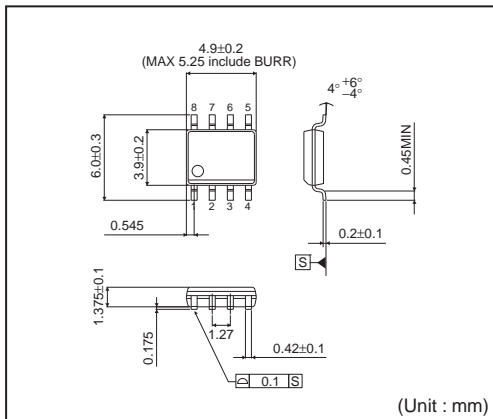

<Tape and Reel information>

Tape	Embossed carrier tape
Quantity	2500pcs
Direction of feed	E2 (The direction is the 1pin of product is at the upper left when you hold reel on the left hand and you pull out the tape on the right hand)

Reel

1pin

Direction of feed

*Order quantity needs to be multiple of the minimum quantity.

SOP8

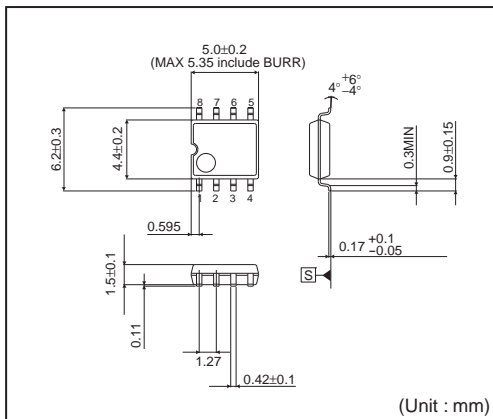

<Tape and Reel information>

Tape	Embossed carrier tape
Quantity	2500pcs
Direction of feed	E2 (The direction is the 1pin of product is at the upper left when you hold reel on the left hand and you pull out the tape on the right hand)

Reel

1pin

Direction of feed

*Order quantity needs to be multiple of the minimum quantity.

TSSOP-B8

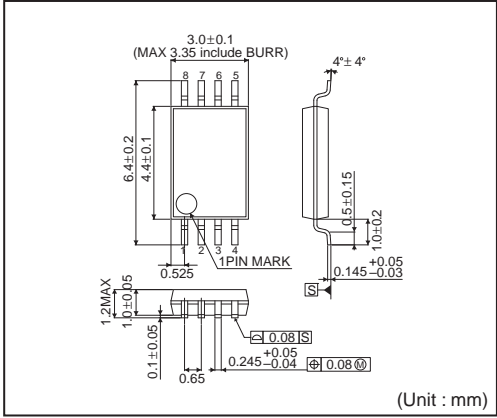

<Tape and Reel information>

Tape	Embossed carrier tape
Quantity	3000pcs
Direction of feed	E2 (The direction is the 1pin of product is at the upper left when you hold reel on the left hand and you pull out the tape on the right hand)

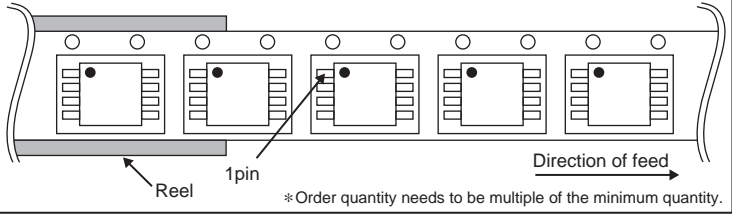

Notes

No copying or reproduction of this document, in part or in whole, is permitted without the consent of ROHM Co.,Ltd.

The content specified herein is subject to change for improvement without notice.

The content specified herein is for the purpose of introducing ROHM's products (hereinafter "Products"). If you wish to use any such Product, please be sure to refer to the specifications, which can be obtained from ROHM upon request.

Examples of application circuits, circuit constants and any other information contained herein illustrate the standard usage and operations of the Products. The peripheral conditions must be taken into account when designing circuits for mass production.

Great care was taken in ensuring the accuracy of the information specified in this document. However, should you incur any damage arising from any inaccuracy or misprint of such information, ROHM shall bear no responsibility for such damage.

The technical information specified herein is intended only to show the typical functions of and examples of application circuits for the Products. ROHM does not grant you, explicitly or implicitly, any license to use or exercise intellectual property or other rights held by ROHM and other parties. ROHM shall bear no responsibility whatsoever for any dispute arising from the use of such technical information.

The Products specified in this document are intended to be used with general-use electronic equipment or devices (such as audio visual equipment, office-automation equipment, communication devices, electronic appliances and amusement devices).

The Products specified in this document are not designed to be radiation tolerant.

While ROHM always makes efforts to enhance the quality and reliability of its Products, a Product may fail or malfunction for a variety of reasons.

Please be sure to implement in your equipment using the Products safety measures to guard against the possibility of physical injury, fire or any other damage caused in the event of the failure of any Product, such as derating, redundancy, fire control and fail-safe designs. ROHM shall bear no responsibility whatsoever for your use of any Product outside of the prescribed scope or not in accordance with the instruction manual.

The Products are not designed or manufactured to be used with any equipment, device or system which requires an extremely high level of reliability the failure or malfunction of which may result in a direct threat to human life or create a risk of human injury (such as a medical instrument, transportation equipment, aerospace machinery, nuclear-reactor controller, fuel-controller or other safety device). ROHM shall bear no responsibility in any way for use of any of the Products for the above special purposes. If a Product is intended to be used for any such special purpose, please contact a ROHM sales representative before purchasing.

If you intend to export or ship overseas any Product or technology specified herein that may be controlled under the Foreign Exchange and the Foreign Trade Law, you will be required to obtain a license or permit under the Law.



Thank you for your accessing to ROHM product informations.
More detail product informations and catalogs are available, please contact us.

ROHM Customer Support System

<http://www.rohm.com/contact/>