

Coaxial High Pass Filter

ZFHP-1R2+

50Ω 1.2 to 800 MHz

The Big Deal

- Low insertion loss
- High rejection
- Connectorized package



CASE STYLE: H16

Product Overview

ZFHP-1R2+ is a High pass filter in a connectorized package. This low frequency cut-off high pass filter eliminates noise that feed into RF / base band circuits from low frequency sources.

Key Features

Feature	Advantages
Low insertion loss	Can be used in high performance applications.
Excellent low frequency rejection	Filters out low frequency noise from sources such as electric motors and generators. SMDS noise filtering and IF noise filtering.
Connectorized package	The connectorized package is easy to interface with other devices and well suited for test setups.

Notes

- A. Performance and quality attributes and conditions not expressly stated in this specification document are intended to be excluded and do not form a part of this specification document.
B. Electrical specifications and performance data contained in this specification document are based on Mini-Circuit's applicable established test performance criteria and measurement instructions.
C. The parts covered by this specification document are subject to Mini-Circuits standard limited warranty and terms and conditions (collectively, "Standard Terms"); Purchasers of this part are entitled to the rights and benefits contained therein. For a full statement of the Standard Terms and the exclusive rights and remedies thereunder, please visit Mini-Circuits' website at www.minicircuits.com/MCLStore/terms.jsp



Coaxial High Pass Filter

ZFHP-1R2+

50Ω 1.2 to 800 MHz



CASE STYLE: H16

Connectors Model
SMA-FEMALE ZFHP-1R2-S+
BRACKET (OPTION "B")

Features

- Wide band, 1.2 MHz to 800 MHz
- High rejection
- Connectorized package

Applications

- Wire-line broad band access
- Fiber optic networks
- Receivers \ transmitters
- Electrical equipment noise elimination

Electrical Specifications at 25°C

Parameter	F#	Frequency (MHz)	Min.	Typ.	Max.	Unit	
Stop Band	Rejection Loss	DC-F1	DC-0.5	20	40	-	dB
	VSWR	DC-F1	DC-0.5	-	158	-	:1
Pass Band	Insertion Loss	F2-F3	1.2-800	-	0.8	2	dB
	VSWR	F2-F3	1.2-800	-	1.5	-	:1

Maximum Ratings

Operating Temperature	-40°C to 85°C
Storage Temperature	-55°C to 100°C
RF Power Input	+5 dBm max.

Permanent damage may occur if any of these limits are exceeded.

Functional Schematic

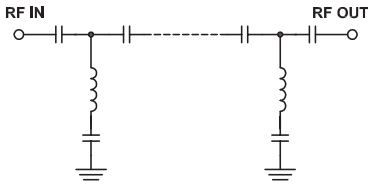

Typical Performance Data at 25°C

Frequency (MHz)	Insertion Loss (dB)	VSWR (:1)
0.030	84.50	1737.18
0.250	68.73	579.06
0.500	53.36	193.02
0.600	47.28	91.43
0.700	41.48	38.61
0.750	28.71	19.54
0.800	7.51	2.84
0.850	1.53	1.76
0.900	1.10	1.76
0.950	0.74	1.54
1.000	0.55	1.43
1.200	0.28	1.29
1.500	0.15	1.13
5.000	0.08	1.22
50.000	0.32	1.07
250.000	0.27	1.04
500.000	0.42	1.05
600.000	0.40	1.02
700.000	0.54	1.01
800.000	0.61	1.03

Typical Frequency Response

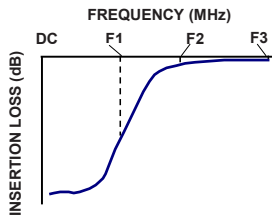

+RoHS Compliant

The +Suffix identifies RoHS Compliance. See our web site for RoHS Compliance methodologies and qualifications

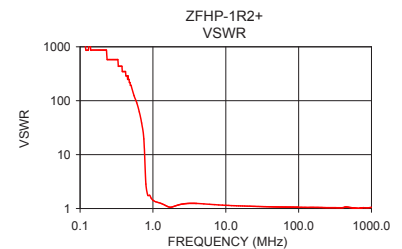
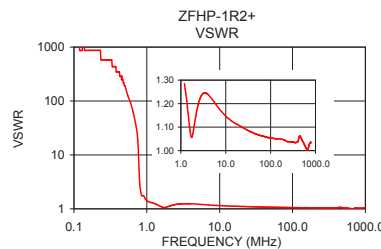
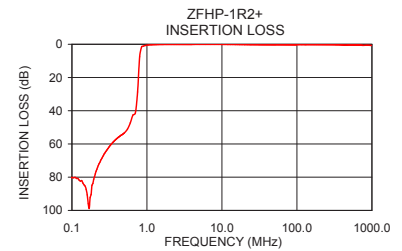
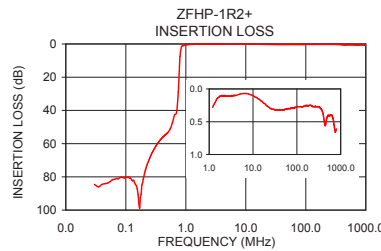

Notes

- Performance and quality attributes and conditions not expressly stated in this specification document are intended to be excluded and do not form a part of this specification document.
- Electrical specifications and performance data contained in this specification document are based on Mini-Circuit's applicable established test performance criteria and measurement instructions.
- The parts covered by this specification document are subject to Mini-Circuits standard limited warranty and terms and conditions (collectively, "Standard Terms"); Purchasers of this part are entitled to the rights and benefits contained therein. For a full statement of the Standard Terms and the exclusive rights and remedies thereunder, please visit Mini-Circuits' website at www.minicircuits.com/MCLStore/terms.jsp



www.minicircuits.com P.O. Box 350166, Brooklyn, NY 11235-0003 (718) 934-4500 sales@minicircuits.com

REVA
M151121
ZFHP-1R2+
EDU1025
URJ
150513
Page 2 of 3

Coaxial Connections

INPUT	SMA-Female
OUTPUT	SMA-Female

Outline Drawing

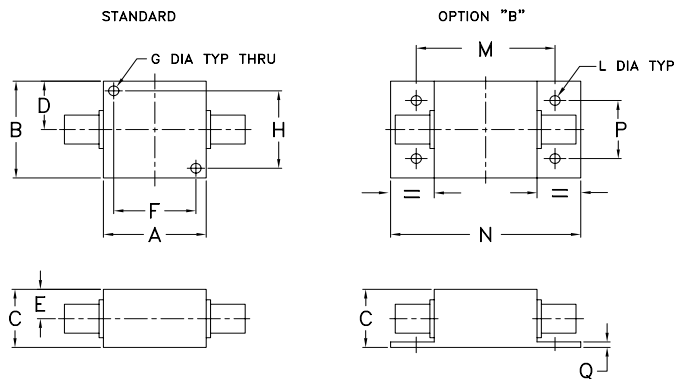

Outline Dimensions ($\frac{\text{inch}}$ / mm)

A	B	C	D	E	F	G	H
.25	1.25	.75	.63	.38	1.000	.125	1.000
.75	31.75	19.05	16.00	9.65	25.40	3.18	25.40
J	K	L	M	N	P	Q	wt
--	--	.125	1.688	2.18	.750	.06	grams
--	--	3.18	42.88	55.37	19.05	1.52	70.0

Notes

- A. Performance and quality attributes and conditions not expressly stated in this specification document are intended to be excluded and do not form a part of this specification document.
 B. Electrical specifications and performance data contained in this specification document are based on Mini-Circuit's applicable established test performance criteria and measurement instructions.
 C. The parts covered by this specification document are subject to Mini-Circuits standard limited warranty and terms and conditions (collectively, "Standard Terms"); Purchasers of this part are entitled to the rights and benefits contained therein. For a full statement of the Standard Terms and the exclusive rights and remedies thereunder, please visit Mini-Circuits' website at www.minicircuits.com/MCLStore/terms.jsp

