

# ACMD-7602

## Miniature UMTS Band I Duplexer

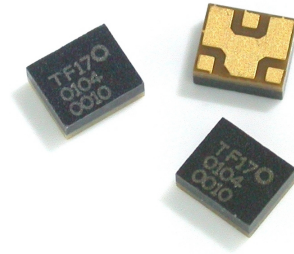

### Data Sheet



#### Description

The Avago ACMD-7602 is a miniature duplexer designed for use in UMTS Band I handsets.

Maximum Insertion Loss in the Tx channel is only 1.5 dB, which minimizes current drain from the power amplifier. Insertion Loss in the Rx channel is a maximum of 2.0 dB, improving receiver sensitivity.

The ACMD-7602 enhances the sensitivity and dynamic range of WCDMA receivers by providing more than 53 dB attenuation of the transmitted signal at the receiver input and more than 43 dB rejection of transmit-generated noise in the receive band.

The ACMD-7602 is designed with Avago Technologies' Film Bulk Acoustic Resonator (FBAR) technology, which makes possible ultra-small, high-Q filters at a fraction of their usual size. The excellent power handling capability of the FBAR bulk-mode resonators supports the high output power levels needed in handsets while adding virtually no distortion.

The ACMD-7602 also utilizes Avago Technologies' innovative Microcap bonded-wafer, chip scale packaging technology. This process allows the filters to be assembled in a molded chip-on-board module that is less than 1.2 mm high with a maximum footprint of only 2.5 mm x 3.0 mm.

#### Features

- Miniature size
  - 2.5 x 3.0 mm max footprint
  - 1.2 mm max height
- High power rating
  - +33 dBm Abs Max Tx Power
- Lead-free construction

#### Specifications

- Performance guaranteed -30 to +85°C
- Rx band performance (2110 – 2170 mHz)
  - Insertion loss: 2.0 dB max
  - Noise blocking: 43 dB min
- Tx band performance (1920 – 1980 mHz)
  - Insertion loss: 1.5 dB max
  - Interferer blocking: 53 dB min

#### Applications

- Handsets or data terminals operating in the UMTS Band I frequency range

#### Functional Block Diagram

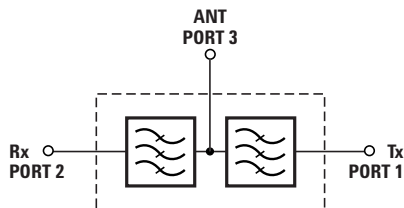

## ACMD-7602 Specifications, $Z_0 = 50 \Omega$ , $T_C$ <sup>[1]</sup> as Indicated

Symbol	Parameter	Units	-30 to +85°C <sup>[2]</sup>		
			Min.	Typ. <sup>[3]</sup>	Max.
<b>Antenna Port to Receive Port</b>					
S23	Insertion Loss in Receive Band (2110 – 2170 MHz)	dB		1.1	2.0
$\Delta S23$	Ripple (p-p) in Receive Band	dB		0.6	1.0
$\Delta S23$	Ripple (p-p) in Any 5 MHz Channel within Receive Band	dB		–	0.5
S22	Return Loss of Receive Port in Receive Band	dB	10	16	
S23	Attenuation 0 – 1900 mHz	dB	30	50	
S23	Attenuation in Transmit Band (1920 – 1980 mHz)	dB	53	61	
S23	Attenuation in Bluetooth Band (2400 – 2500 mHz)	dB	40	54	
<b>Transmit Port to Antenna Port</b>					
S31	Insertion Loss in Transmit Band (1920 – 1980 mHz) -30° to +25°C	dB		1.1	1.5
S31	Insertion Loss in Transmit Band (1920 – 1980 mHz) +25° to +85°C	dB		1.1	1.6
$\Delta S31$	Ripple (p-p) in Transmit Band	dB		0.4	1.0
$\Delta S31$	Ripple (p-p) in Any 5 mHz Channel within Transmit Band	dB		–	0.5
S11	Return Loss of Transmit Port in Transmit Band	dB	10	20	
S31	Attenuation 0 – 1800 mHz	dB	30	44	
S31	Attenuation in Receive Band (2110 – 2170 mHz)	dB	41	52	
S31	Attenuation in Bluetooth Band (2400 – 2500 mHz)	dB	25	31	
S31	Attenuation in Transmit 2nd Harmonic Band (3840 – 3960 mHz)	dB	25	36	
S31	Attenuation in Transmit 3rd Harmonic Band (5760 – 5940 mHz)	dB	15	17	
<b>Antenna Port</b>					
S33	Return Loss of Antenna Port in Transmit and Receive Bands	dB	10	17	
<b>Isolation Transmit Port to Receive Port</b>					
S21	Tx-Rx Isolation in Transmit Band (1920 – 1980 mHz)	dB	53	62	
S21	Tx-Rx Isolation in Receive Band (2110 – 2170 mHz)	dB	43	52	

### Notes:

- $T_C$  is the case temperature and is defined as the temperature of the underside of the duplexer where it makes contact with the circuit board.
- Specifications guaranteed over the given temperature range (unless otherwise noted) with the input power to the Tx port equal to or less than +29 dBm over all Tx frequencies.
- Typical data is the arithmetic mean value of the parameter over its indicated frequency range at the specified temperature. Typical values may vary from part to part and over time.

## Absolute Maximum Ratings<sup>[1]</sup>

Parameter	Unit	Value
Storage Temperature	°C	-65 to +125
Maximum RF Input Power to Tx Port	dBm	+33

## Maximum Recommended Operating Conditions<sup>[2]</sup>

Parameter	Unit	Value
Operating Temperature, $T_C$ <sup>[3]</sup> , Tx Power $\leq$ 29 dBm	°C	-40 to +100
Operating Temperature, $T_C$ <sup>[3]</sup> , Tx Power $\leq$ 30 dBm	°C	-40 to +85

### Notes:

1. Operation in excess of any one of these conditions may result in permanent damage to the device.
2. The device will function over the recommended range without degradation in reliability or permanent change in performance, but is not guaranteed to meet electrical specifications.
3.  $T_C$  is defined as case temperature, the temperature of the underside of the duplexer where it makes contact with the circuit board.

## ACMD-7602 Typical Performance at $T_C = 25^\circ\text{C}$

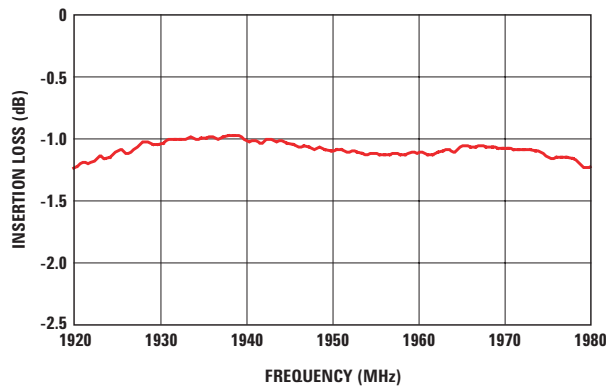

Figure 1. Tx band insertion loss

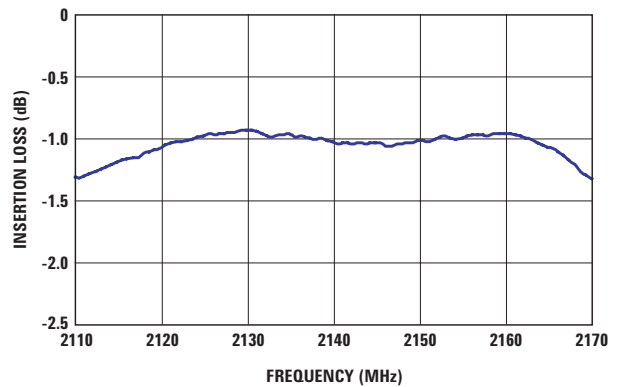

Figure 2. Rx band insertion loss

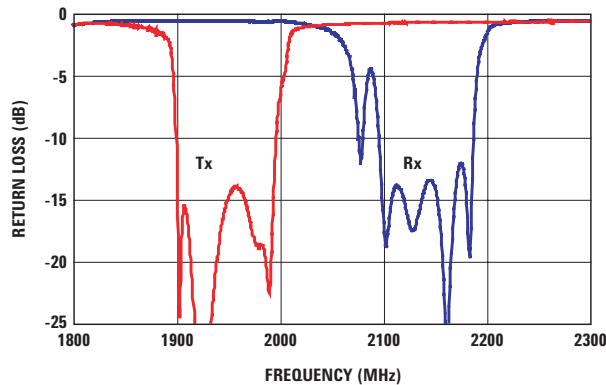

Figure 3. Tx and Rx port return loss

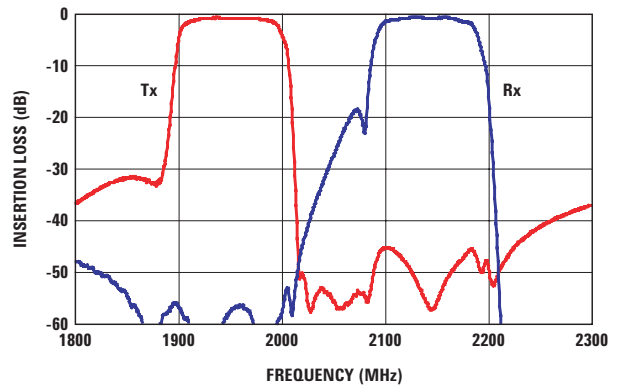

Figure 4. Tx rejection in Rx band and Rx rejection in Tx band

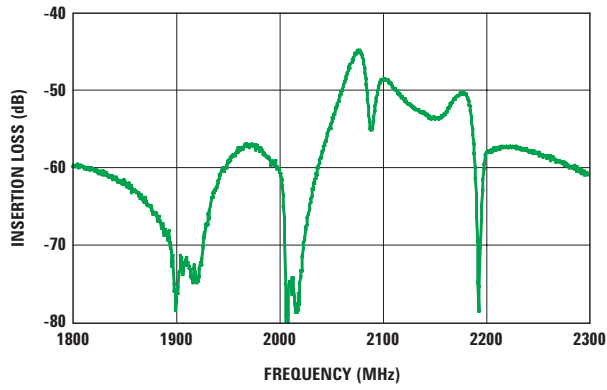

Figure 5. Tx to Rx isolation

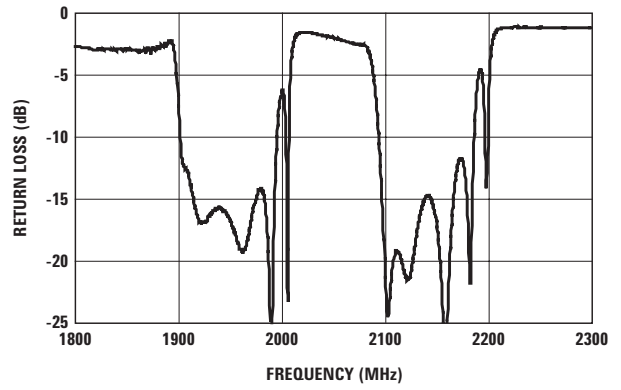

Figure 6. Antenna port return loss

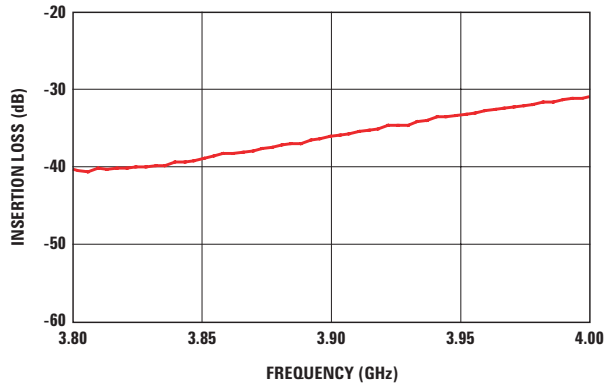

Figure 7. Tx second harmonic rejection

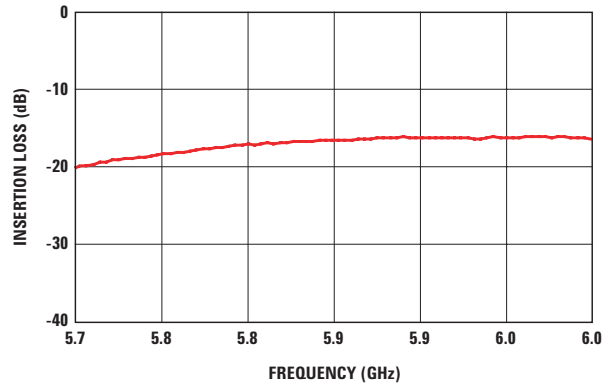

Figure 8. Tx third harmonic rejection

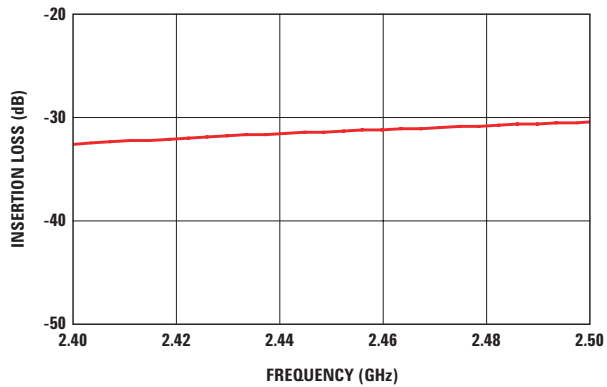

Figure 9. Tx rejection in bluetooth band (2400 – 2500 mHz)

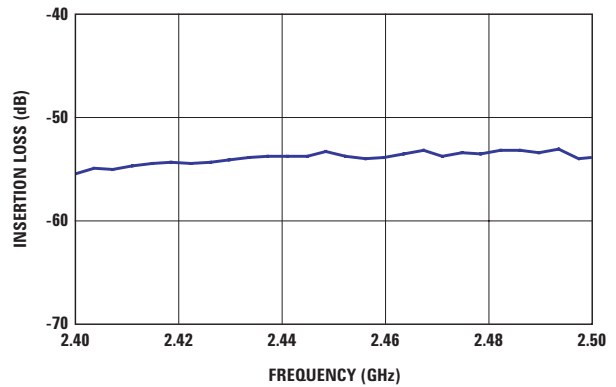

Figure 10. Rx rejection in bluetooth band (2400 – 2500 mHz)

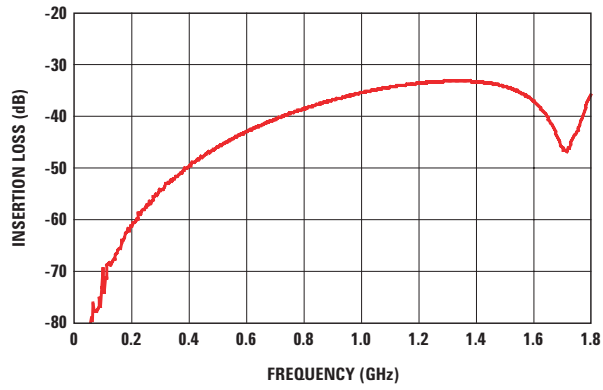

Figure 11. Tx low frequency rejection

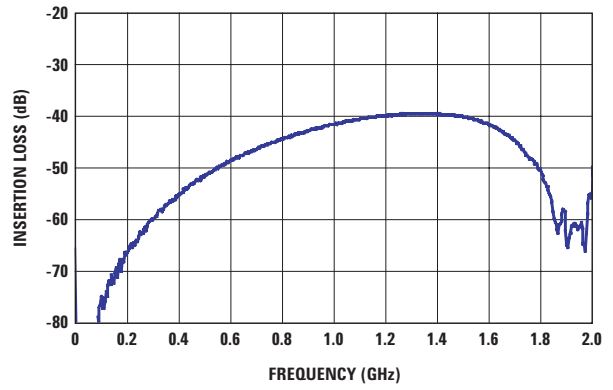

Figure 12. Rx low frequency rejection

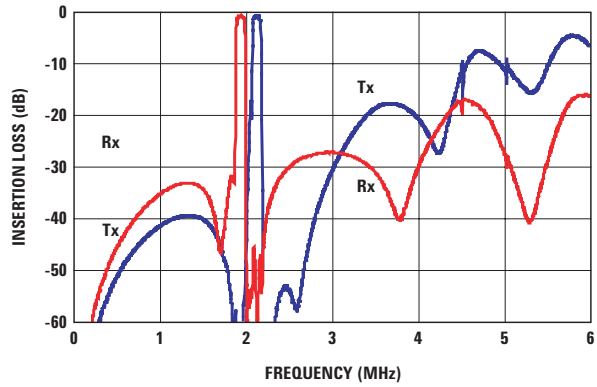

Figure 13. Tx and Rx wideband response

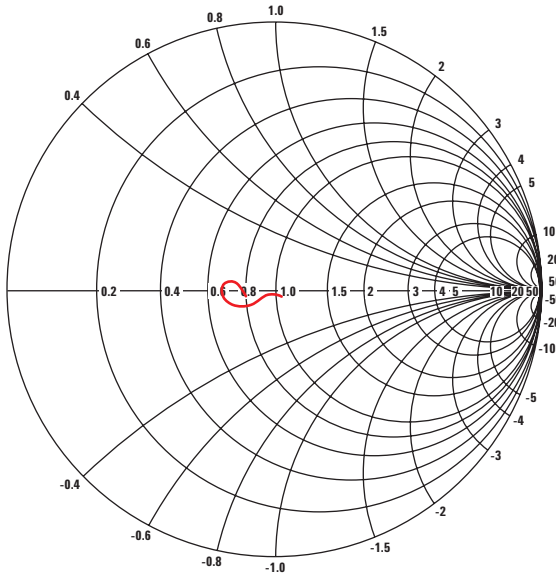

Figure 14. Tx impedance (S11) in Tx band

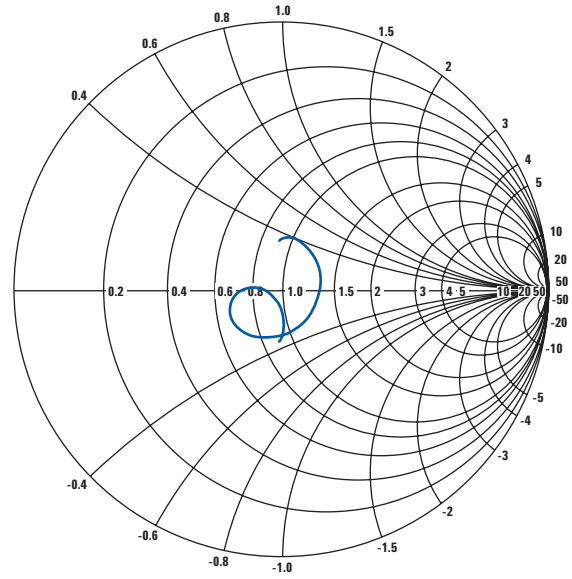

Figure 15. Rx impedance (S22) in Rx band

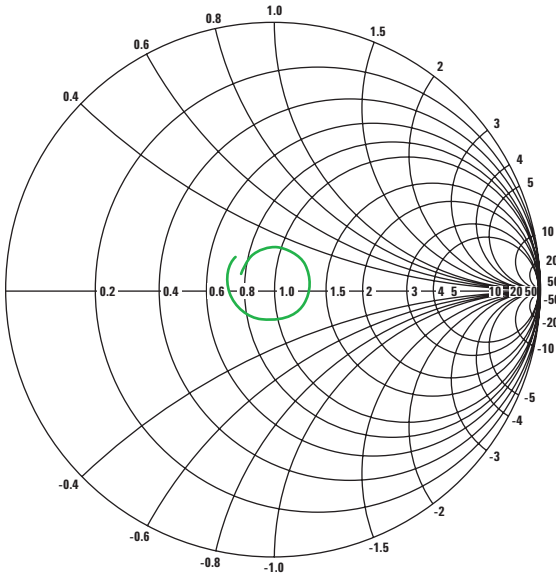

Figure 16. Ant impedance (S33) in Tx band

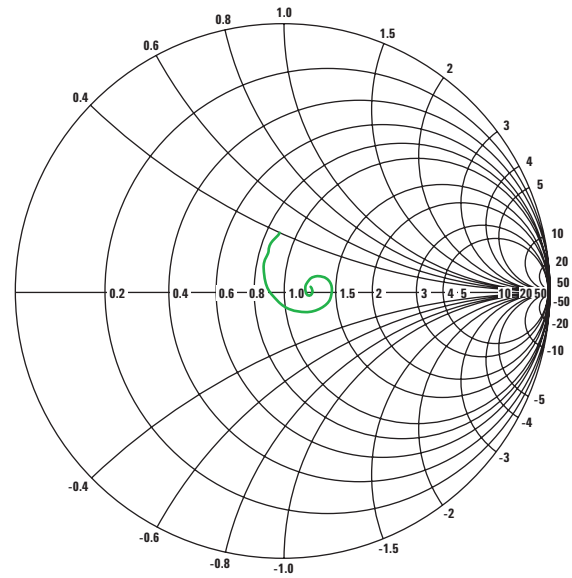
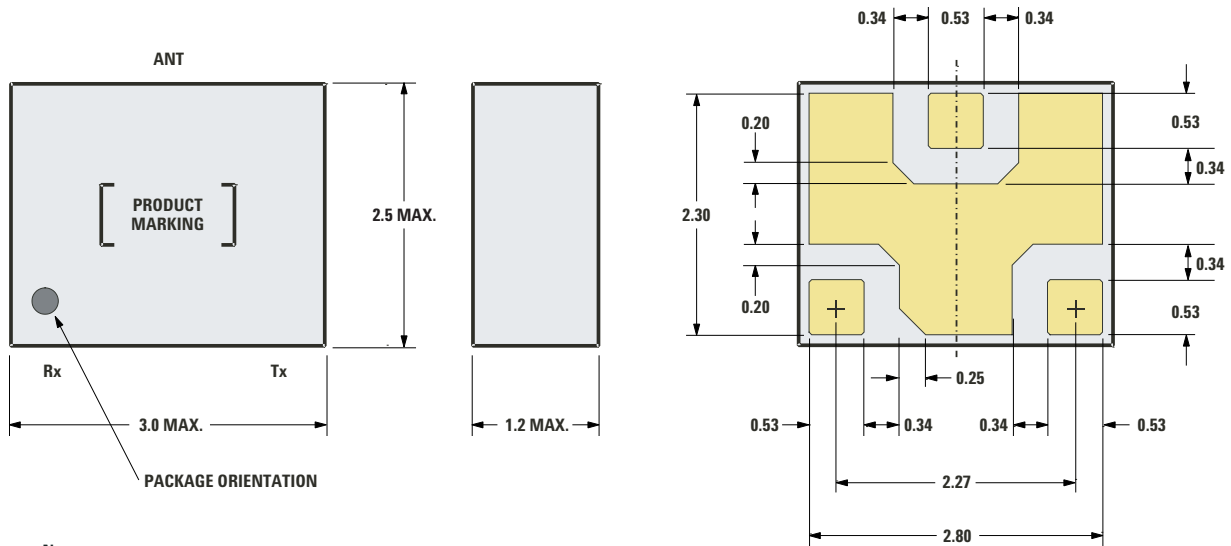

Figure 17. Ant impedance (S33) in Rx band



**Notes:**

1. Dimensions in millimeters.
2. Dimensions nominal unless otherwise noted.
3. All chamfers 45°.
4. I/O pads (3 ea):  
 Size: 0.53 x 0.53, corner chamfers: 0.03 x 0.03  
 Spacing to ground plane: 0.34  
 Inside ground plane chamfer: 0.20 x 0.20
5. Tolerance:  
 X.X = ± 0.1  
 X.XX = ± 0.05
6. Contact areas are gold plated.



**Figure 18. Package drawing**

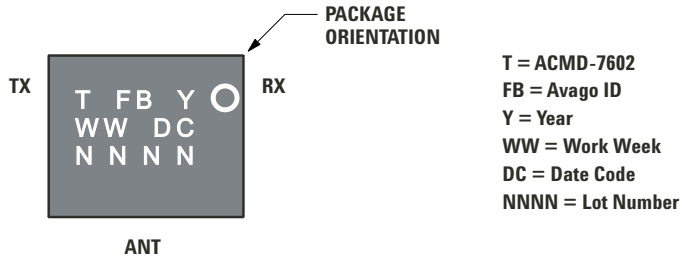

**Figure 19. Package marking**

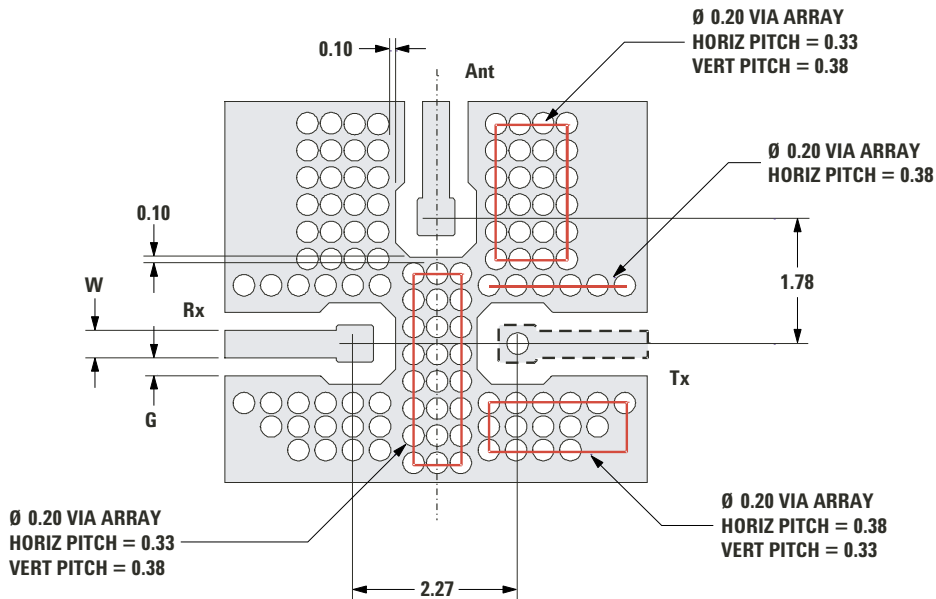

**Notes:**

1. Dimensions in mm.
2. Transmission line Gap (G) and Width (W) adjusted for  $Z_0 = 50$  ohms.
3. I/O Pads (3 ea) 0.53 x 0.53, corner chamfer 0.30.
4. I/O Pad to Ground plane gap = 0.34, corner chamfer 0.30.
5. Ground vias positioned to maximize port-to-port isolation.

**Figure 20. PCB layout**

A PCB layout implementing design principles similar to those illustrated in Figure 16 is recommended to optimize performance of the AMCD-7602.

It is particularly important to maximize isolation between the Tx connection to the duplexer and the Rx port. High isolation is achieved by (1) maintaining a continuous ground plane around the duplexer mounting area, (2) surrounding the I/O ports with sufficient ground vias to enclose the connections in a "Faraday cage", and (3) preferably routing the Tx trace in a different metal layer than the Rx.

The latter is especially useful, not only to maintain Tx-Rx isolation of the duplexer, but also to prevent leakage of the Tx signal into other components that could result in the creation of intermodulation products and degradation of overall system performance.

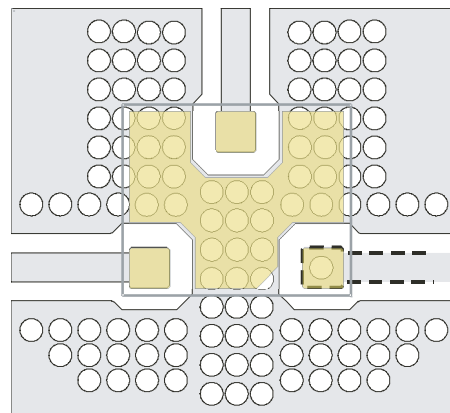

**Figure 21. ACMD-7602 superposed on PCB layout**



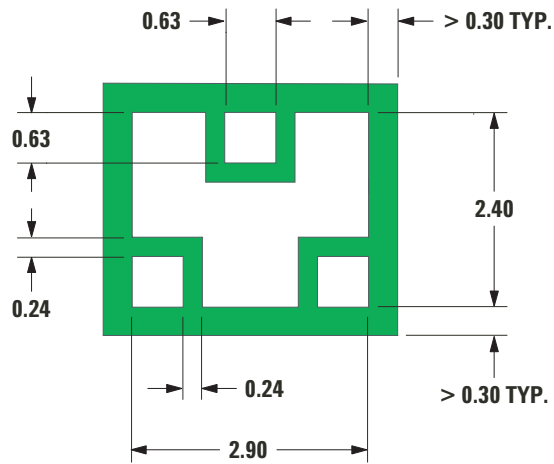

**Note:**  
Dimensions in mm.

**Figure 22. Recommended solder mask**

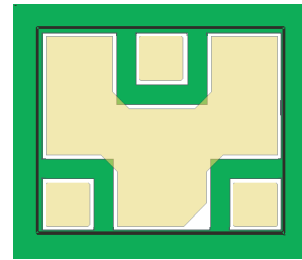

**Figure 23. AMCD-7602 superposed on solder mask**

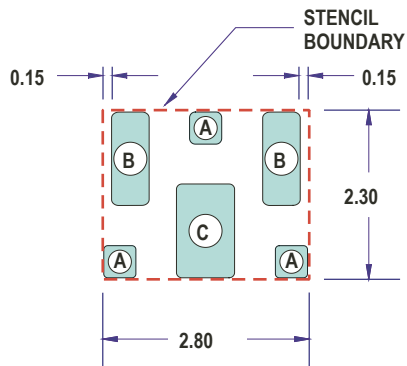

STENCIL OPENING ID	QTY	WIDTH (mm)	LENGTH (mm)
A (I/O pad areas)	3	0.43	0.43
B	2	0.50	1.24
C	1	0.77	1.24

**Notes:**  
1. Chamfer or radius all corners 0.05 mm min.  
2. Stencil openings aligned to Boundary rectangle or center lines.

**Figure 24. Recommended solder stencil**

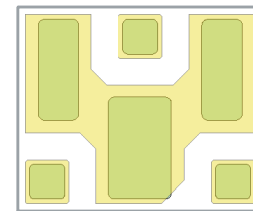

**Figure 25. Solder stencil overlaid on AMCD-7602 bottom metal pattern**

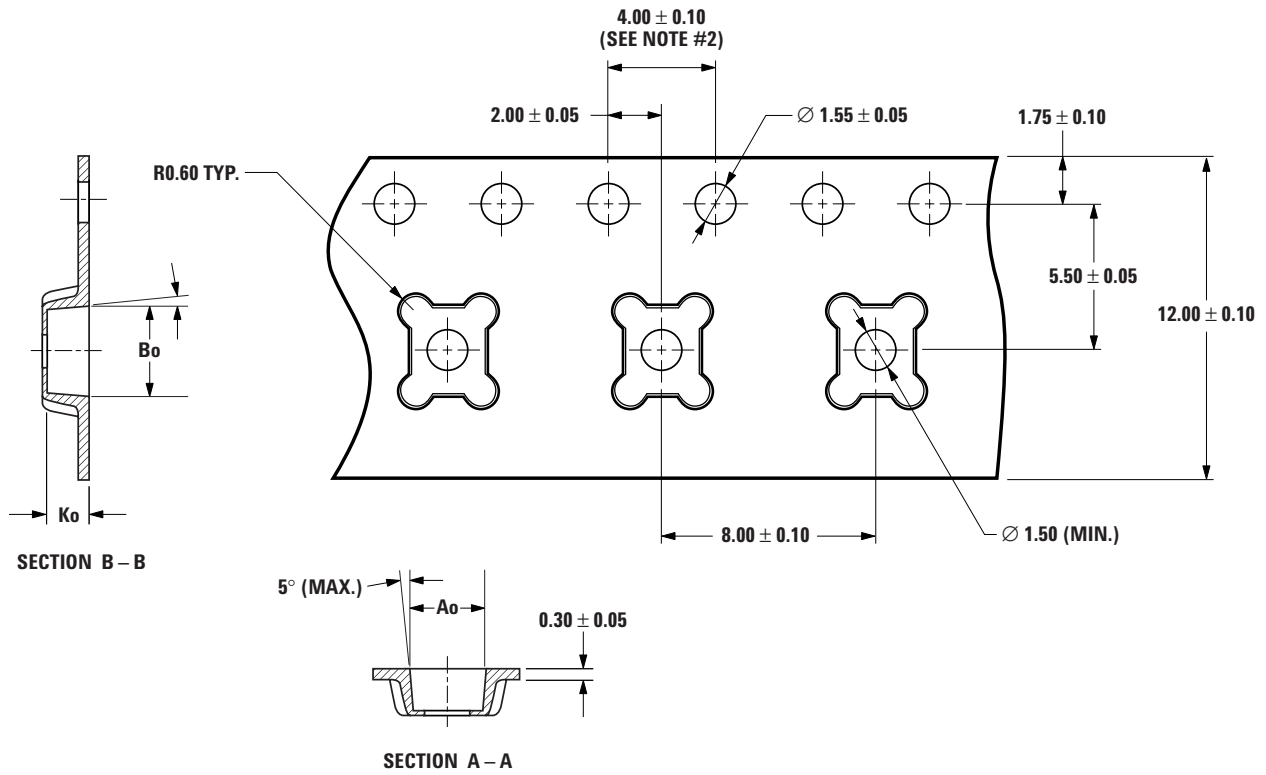

**NOTES:**

1.  $A_o$  and  $B_o$  measured at 0.3 mm above base of pocket.
2. 10 pitches cumulative tolerance  $\pm 0.2$  mm.
3. ( ) Reference dimensions only.

$A_o$	=	2.80
$B_o$	=	3.30
$K_o$	=	1.50
Pitch	=	8.00
Width	=	12.00

Figure 26. SMD tape packing

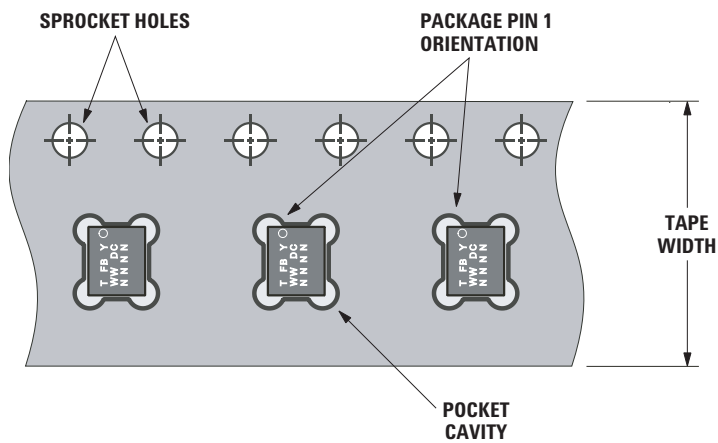

Figure 27. Unit orientation in tape

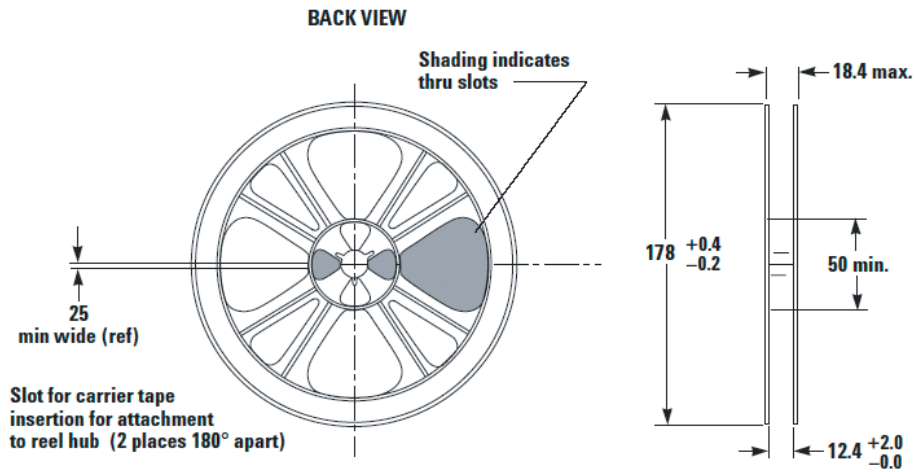
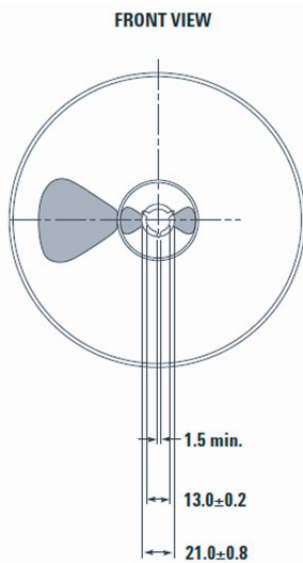

Figure 28. Reel drawing, back view

Reel Component	Resistivity
Reel (coated with proprietary antistatic agent)	10 <sup>9</sup> to 10 <sup>11</sup> Ohm/Sq
Carrier Tape (carbon polystyrene)	10 <sup>9</sup> Ohm/Sq
Cover Tape	10 <sup>9</sup> to 10 <sup>11</sup> Ohm/Sq
Top Layer – transparent PET film	
Bonding Layer – adhesive Polyolefin	
Sealing Layer – peelable, special film	



**Notes:**

1. Reel shall be labeled with the following information (as a minimum):
  - a. Manufactures name or symbol
  - b. Avago Technologies part number
  - c. Purchase order number
  - d. Date code
  - e. Quantity of units
2. A certificate of compliance © of C) shall be issued and accompany each shipment of product.
3. Reel must not be made with or contain ozone depleting materials.
4. All dimensions in millimeters (mm).

Figure 29. Reel drawing, front view

## Package Moisture Sensitivity

Feature	Test Method	Performance
Moisture Sensitivity Level (MSL) at 260°C	J-STD-020C	Level 3

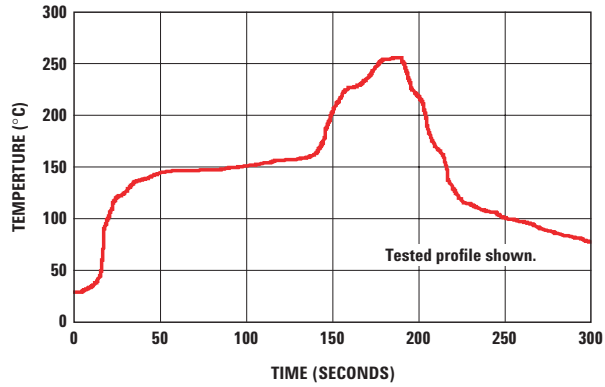

Figure 30. Verified SMT solder profile

## AMCD-7602 Ordering Information

Part Number	No. of Devices	Container
AMCD-7602-BLK	25	Anti-static Bag
AMCD-7602-TR1	1000	178 mm (7-inch) Reel

For product information and a complete list of distributors, please go to our website: [www.avagotech.com](http://www.avagotech.com)

Avago, Avago Technologies, and the A logo are trademarks of Avago Technologies Limited in the United States and other countries. Data subject to change. Copyright © 2007 Avago Technologies Limited. All rights reserved.  
AV02-0472EN - September 25, 2007

**AVAGO**  
TECHNOLOGIES