

# BFR840L3RHESD

## SiGe:C NPN RF bipolar transistor



Order now



Technical documents



Simulation



Support

## Product description

The BFR840L3RHESD is a discrete RF heterojunction bipolar transistor (HBT) with an integrated ESD protection suitable for 5 GHz band applications.



## Feature list

- Unique combination of high end RF performance and robustness: 20 dBm maximum RF input power, 1.5 kV HBM ESD hardness
- High transition frequency  $f_T = 75$  GHz to enable best in class noise performance at high frequencies:  $NF_{min} = 0.65$  dB at 5.5 GHz; 1.1 dB at 12 GHz, 1.8 V, 5 mA
- High gain  $G_{ms} = 22$  dB at 5.5 GHz, 1.8 V, 10 mA
- $OIP_3 = 18$  dBm at 5.5 GHz, 1.8 V, 10 mA
- Ideal for low voltage applications e.g.  $V_{CC} = 1.2$  V and 1.8 V (2.85 V, 3.3 V, 3.6 V require a corresponding collector resistor)
- Low profile and small form factor leadless package

## Product validation

Qualified for industrial applications according to the relevant tests of JEDEC47/20/22.

## Potential applications

- Wireless communications: WLAN 2.4 GHz and 5-6 GHz bands, WiMAX and UWB
- Satellite communication systems: satellite radio (SDARs, DAB), navigation systems (e.g. GPS, GLONASS, BeiDou, Galileo)

## Device information

**Table 1** Part information

Product name / Ordering code	Package	Pin configuration			Marking	Pieces / Reel
BFR840L3RHESD / BFR840L3RHESDE6327XTSA1	TSLP-3-9	1 = B	2 = C	3 = E	T8	15000

**Attention:** ESD (Electrostatic discharge) sensitive device, observe handling precautions

## Table of contents

	<b>Product description</b> .....	1
	<b>Feature list</b> .....	1
	<b>Product validation</b> .....	1
	<b>Potential applications</b> .....	1
	<b>Device information</b> .....	1
	<b>Table of contents</b> .....	2
<b>1</b>	<b>Absolute maximum ratings</b> .....	3
<b>2</b>	<b>Thermal characteristics</b> .....	4
<b>3</b>	<b>Electrical characteristics</b> .....	5
3.1	DC characteristics .....	5
3.2	General AC characteristics .....	5
3.3	Frequency dependent AC characteristics .....	6
3.4	Characteristic DC diagrams .....	10
3.5	Characteristic AC diagrams .....	13
<b>4</b>	<b>Package information TSLP-3-9</b> .....	20
	<b>Revision history</b> .....	21
	<b>Disclaimer</b> .....	22

**Absolute maximum ratings**

**1 Absolute maximum ratings**

**Table 2 Absolute maximum ratings at  $T_A = 25\text{ °C}$  (unless otherwise specified)**

Parameter	Symbol	Values		Unit	Note or test condition
		Min.	Max.		
Collector emitter voltage	$V_{CEO}$	-	2.25	V	Open base
			2.0		$T_A = -55\text{ °C}$ , open base
Collector base voltage <sup>1)</sup>	$V_{CBO}$	-	2.9		Open emitter
			2.6		$T_A = -55\text{ °C}$ , open emitter
Collector emitter voltage <sup>2)</sup>	$V_{CES}$	-	2.25		E-B short circuited
			2.0		$T_A = -55\text{ °C}$ , E-B short circuited
Base current	$I_B$	-5	3	mA	-
Collector current	$I_C$	-	35		
RF input power	$P_{RFIn}$	-	20	dBm	
ESD stress pulse	$V_{ESD}$	-1.5	1.5	kV	HBM, all pins, acc. to JESD22-A114
Total power dissipation <sup>3)</sup>	$P_{tot}$	-	75	mW	$T_S \leq 111\text{ °C}$
Junction temperature	$T_J$	-	150	°C	-
Storage temperature	$T_{Stg}$	-55			

**Attention:** Stresses above the max. values listed here may cause permanent damage to the device. Exposure to absolute maximum rating conditions for extended periods may affect device reliability. Exceeding only one of these values may cause irreversible damage to the integrated circuit.

<sup>1</sup>  $V_{CBO}$  is identical to  $V_{CEO}$  due to design.

<sup>2</sup>  $V_{CES}$  is similar to  $V_{CEO}$  due to design.

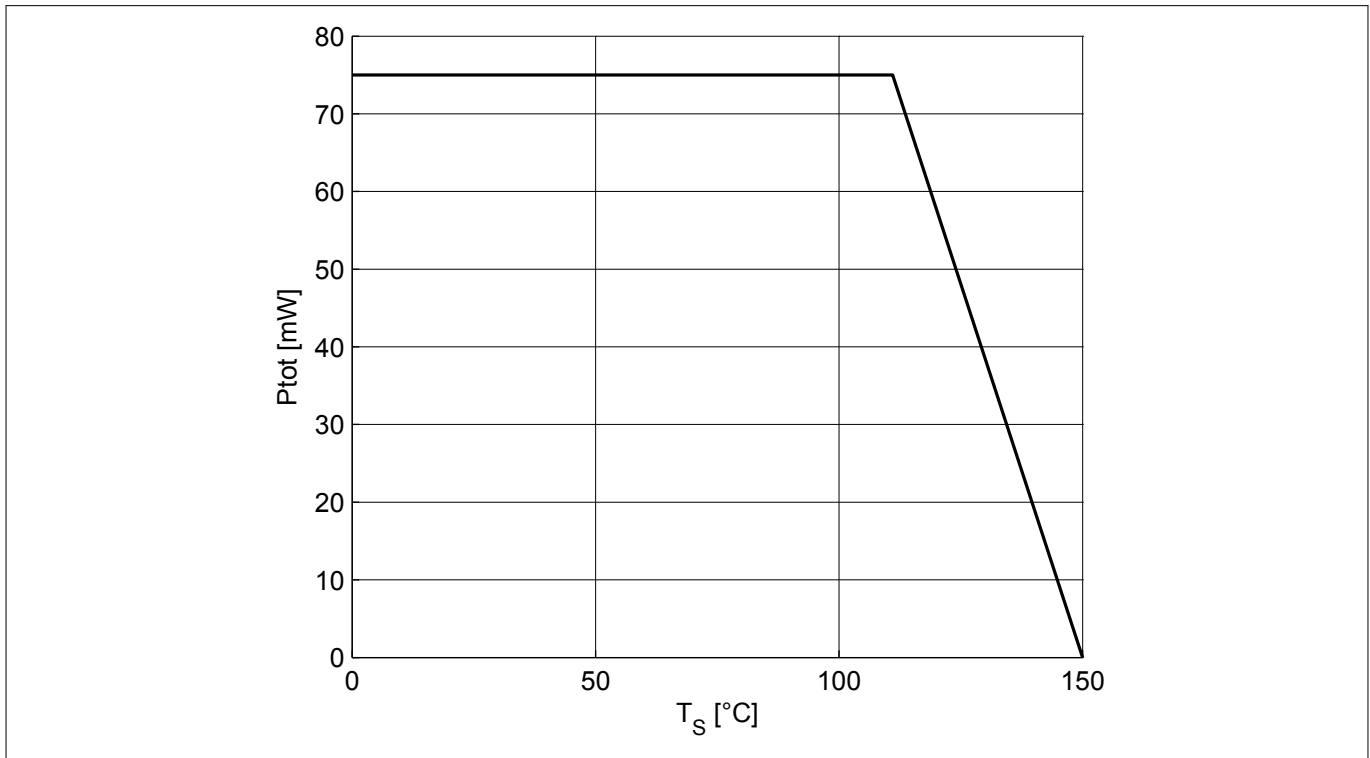
<sup>3</sup>  $T_S$  is the soldering point temperature.  $T_S$  is measured on the emitter lead at the soldering point of the PCB.

Thermal characteristics

## 2 Thermal characteristics

**Table 3 Thermal resistance**

Parameter	Symbol	Values			Unit	Note or test condition
		Min.	Typ.	Max.		
Junction - soldering point	$R_{thJS}$	-	521	-	K/W	-



**Figure 1 Total power dissipation  $P_{tot} = f(T_S)$**

**Electrical characteristics**

**3 Electrical characteristics**

**3.1 DC characteristics**

**Table 4 DC characteristics at  $T_A = 25\text{ °C}$**

Parameter	Symbol	Values			Unit	Note or test condition
		Min.	Typ.	Max.		
Collector emitter breakdown voltage	$V_{(BR)CEO}$	2.25	2.6	–	V	$I_C = 1\text{ mA}$ , $I_B = 0$ , open base
Collector emitter leakage current	$I_{CES}$	–	–	400 <sup>1)</sup>	nA	$V_{CE} = 1.5\text{ V}$ , $V_{BE} = 0$ , E-B short circuited
Collector base leakage current	$I_{CBO}$			400 <sup>1)</sup>		$V_{CB} = 1.5\text{ V}$ , $I_E = 0$ , open emitter
Emitter base leakage current	$I_{EBO}$			10 <sup>1)</sup>	$\mu\text{A}$	$V_{EB} = 0.5\text{ V}$ , $I_C = 0$ , open collector
DC current gain	$h_{FE}$	150	260	450		$V_{CE} = 1.8\text{ V}$ , $I_C = 10\text{ mA}$ , pulse measured

**3.2 General AC characteristics**

**Table 5 General AC characteristics at  $T_A = 25\text{ °C}$**

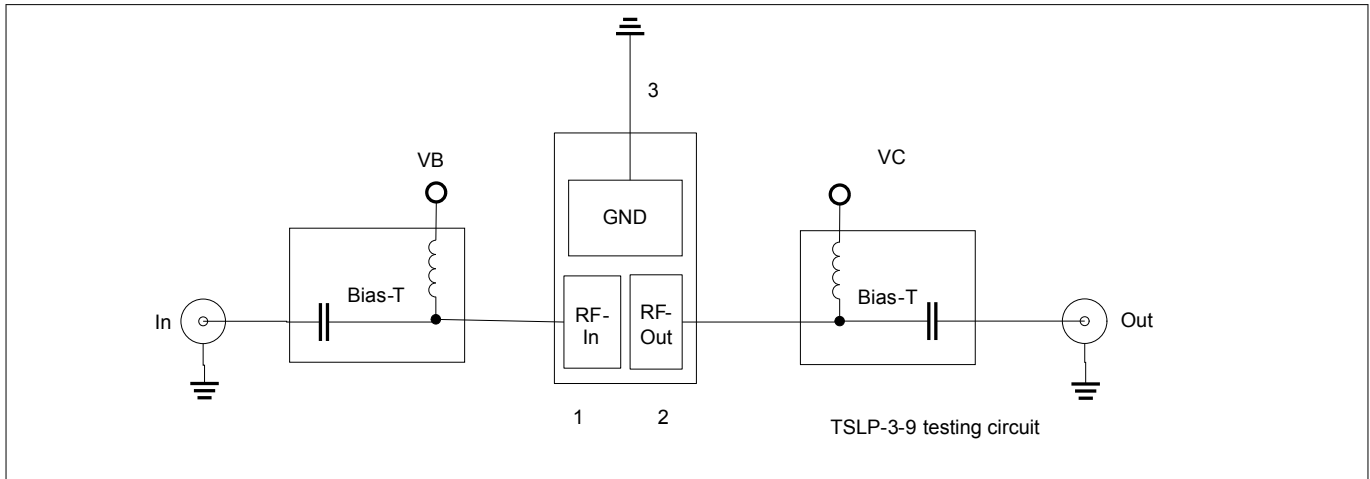
Parameter	Symbol	Values			Unit	Note or test condition
		Min.	Typ.	Max.		
Transition frequency	$f_T$	–	75	–	GHz	$V_{CE} = 1.8\text{ V}$ , $I_C = 25\text{ mA}$ , $f = 2\text{ GHz}$
Collector base capacitance	$C_{CB}$		52		fF	$V_{CB} = 1.8\text{ V}$ , $V_{BE} = 0$ , $f = 1\text{ MHz}$ , emitter grounded
Collector emitter capacitance	$C_{CE}$		0.34		pF	$V_{CE} = 1.8\text{ V}$ , $V_{BE} = 0$ , $f = 1\text{ MHz}$ , base grounded
Emitter base capacitance	$C_{EB}$		0.34			$V_{EB} = 0.4\text{ V}$ , $V_{CB} = 0$ , $f = 1\text{ MHz}$ , collector grounded

<sup>1</sup> Maximum values not limited by the device but by the short cycle time of the 100% test

**Electrical characteristics**

**3.3 Frequency dependent AC characteristics**

Measurement setup is a test fixture with Bias-T's in a 50 Ω system,  $T_A = 25\text{ °C}$ .



**Figure 2 Testing circuit**

**Table 6 AC characteristics,  $V_{CE} = 1.8\text{ V}$ ,  $f = 0.45\text{ GHz}$**

Parameter	Symbol	Values			Unit	Note or test condition
		Min.	Typ.	Max.		
Power gain		–		–	dB	$I_C = 10\text{ mA}$
<ul style="list-style-type: none"> <li>Maximum power gain</li> <li>Transducer gain</li> </ul>	$G_{ms}$ $ S_{21} ^2$		31 27			
Noise figure					dB	$I_C = 5\text{ mA}$
<ul style="list-style-type: none"> <li>Minimum noise figure</li> <li>Associated gain</li> </ul>	$NF_{min}$ $G_{ass}$		0.5 27			
Linearity					dBm	$Z_S = Z_L = 50\text{ }\Omega$ , $I_C = 10\text{ mA}$
<ul style="list-style-type: none"> <li>3rd order intercept point at output</li> <li>1 dB gain compression point at output</li> </ul>	$OIP_3$ $OP_{1dB}$		21 4			

**Table 7 AC characteristics,  $V_{CE} = 1.8\text{ V}$ ,  $f = 0.9\text{ GHz}$**

Parameter	Symbol	Values			Unit	Note or test condition
		Min.	Typ.	Max.		
Power gain		–		–	dB	$I_C = 10\text{ mA}$
<ul style="list-style-type: none"> <li>Maximum power gain</li> <li>Transducer gain</li> </ul>	$G_{ms}$ $ S_{21} ^2$		29 26.5			
Noise figure					dB	$I_C = 5\text{ mA}$
<ul style="list-style-type: none"> <li>Minimum noise figure</li> <li>Associated gain</li> </ul>	$NF_{min}$ $G_{ass}$		0.55 26			
Linearity					dBm	$Z_S = Z_L = 50\text{ }\Omega$ , $I_C = 10\text{ mA}$
<ul style="list-style-type: none"> <li>3rd order intercept point at output</li> <li>1 dB gain compression point at output</li> </ul>	$OIP_3$ $OP_{1dB}$		18.5 4			

**Electrical characteristics**

**Table 8 AC characteristics,  $V_{CE} = 1.8\text{ V}$ ,  $f = 1.5\text{ GHz}$**

Parameter	Symbol	Values			Unit	Note or test condition
		Min.	Typ.	Max.		
Power gain	$G_{ms}$ $ S_{21} ^2$	–	27	–	dB	$I_C = 10\text{ mA}$
• Maximum power gain			25.5			
• Transducer gain						
Noise figure	$NF_{min}$ $G_{ass}$		0.55			$I_C = 5\text{ mA}$
• Minimum noise figure			24.5			
• Associated gain						
Linearity	$OIP_3$ $OP_{1dB}$		17		dBm	$Z_S = Z_L = 50\ \Omega$ , $I_C = 10\text{ mA}$
• 3rd order intercept point at output			4			
• 1 dB gain compression point at output						

**Table 9 AC characteristics,  $V_{CE} = 1.8\text{ V}$ ,  $f = 1.9\text{ GHz}$**

Parameter	Symbol	Values			Unit	Note or test condition
		Min.	Typ.	Max.		
Power gain	$G_{ms}$ $ S_{21} ^2$	–	26.5	–	dB	$I_C = 10\text{ mA}$
• Maximum power gain			25			
• Transducer gain						
Noise figure	$NF_{min}$ $G_{ass}$		0.6			$I_C = 5\text{ mA}$
• Minimum noise figure			24			
• Associated gain						
Linearity	$OIP_3$ $OP_{1dB}$		17		dBm	$Z_S = Z_L = 50\ \Omega$ , $I_C = 10\text{ mA}$
• 3rd order intercept point at output			4			
• 1 dB gain compression point at output						

**Table 10 AC characteristics,  $V_{CE} = 1.8\text{ V}$ ,  $f = 2.4\text{ GHz}$**

Parameter	Symbol	Values			Unit	Note or test condition
		Min.	Typ.	Max.		
Power gain	$G_{ms}$ $ S_{21} ^2$	–	25.5	–	dB	$I_C = 10\text{ mA}$
• Maximum power gain			24			
• Transducer gain						
Noise figure	$NF_{min}$ $G_{ass}$		0.6			$I_C = 5\text{ mA}$
• Minimum noise figure			22.5			
• Associated gain						
Linearity	$OIP_3$ $OP_{1dB}$		17		dBm	$Z_S = Z_L = 50\ \Omega$ , $I_C = 10\text{ mA}$
• 3rd order intercept point at output			4			
• 1 dB gain compression point at output						

**Electrical characteristics**

**Table 11 AC characteristics,  $V_{CE} = 1.8\text{ V}$ ,  $f = 3.5\text{ GHz}$**

Parameter	Symbol	Values			Unit	Note or test condition
		Min.	Typ.	Max.		
Power gain		-		-	dB	$I_C = 10\text{ mA}$
<ul style="list-style-type: none"> <li>Maximum power gain</li> <li>Transducer gain</li> </ul>	$G_{ms}$ $ S_{21} ^2$		 23.5 22			
Noise figure						$I_C = 5\text{ mA}$
<ul style="list-style-type: none"> <li>Minimum noise figure</li> <li>Associated gain</li> </ul>	$NF_{min}$ $G_{ass}$		 0.6 20			
Linearity					dBm	$Z_S = Z_L = 50\ \Omega$ , $I_C = 10\text{ mA}$
<ul style="list-style-type: none"> <li>3rd order intercept point at output</li> <li>1 dB gain compression point at output</li> </ul>	$OIP_3$ $OP_{1dB}$		 18 4			

**Table 12 AC characteristics,  $V_{CE} = 1.8\text{ V}$ ,  $f = 5.5\text{ GHz}$**

Parameter	Symbol	Values			Unit	Note or test condition
		Min.	Typ.	Max.		
Power gain		-		-	dB	$I_C = 10\text{ mA}$
<ul style="list-style-type: none"> <li>Maximum power gain</li> <li>Transducer gain</li> </ul>	$G_{ms}$ $ S_{21} ^2$		 22 19			
Noise figure						$I_C = 5\text{ mA}$
<ul style="list-style-type: none"> <li>Minimum noise figure</li> <li>Associated gain</li> </ul>	$NF_{min}$ $G_{ass}$		 0.65 16.5			
Linearity					dBm	$Z_S = Z_L = 50\ \Omega$ , $I_C = 10\text{ mA}$
<ul style="list-style-type: none"> <li>3rd order intercept point at output</li> <li>1 dB gain compression point at output</li> </ul>	$OIP_3$ $OP_{1dB}$		 18 4			

**Table 13 AC characteristics,  $V_{CE} = 1.8\text{ V}$ ,  $f = 10\text{ GHz}$**

Parameter	Symbol	Values			Unit	Note or test condition
		Min.	Typ.	Max.		
Power gain		-		-	dB	$I_C = 10\text{ mA}$
<ul style="list-style-type: none"> <li>Maximum power gain</li> <li>Transducer gain</li> </ul>	$G_{ma}$ $ S_{21} ^2$		 16 13			
Noise figure						$I_C = 5\text{ mA}$
<ul style="list-style-type: none"> <li>Minimum noise figure</li> <li>Associated gain</li> </ul>	$NF_{min}$ $G_{ass}$		 0.9 11.5			
Linearity					dBm	$Z_S = Z_L = 50\ \Omega$ , $I_C = 10\text{ mA}$
<ul style="list-style-type: none"> <li>3rd order intercept point at output</li> <li>1 dB gain compression point at output</li> </ul>	$OIP_3$ $OP_{1dB}$		 17 3			



**Electrical characteristics**

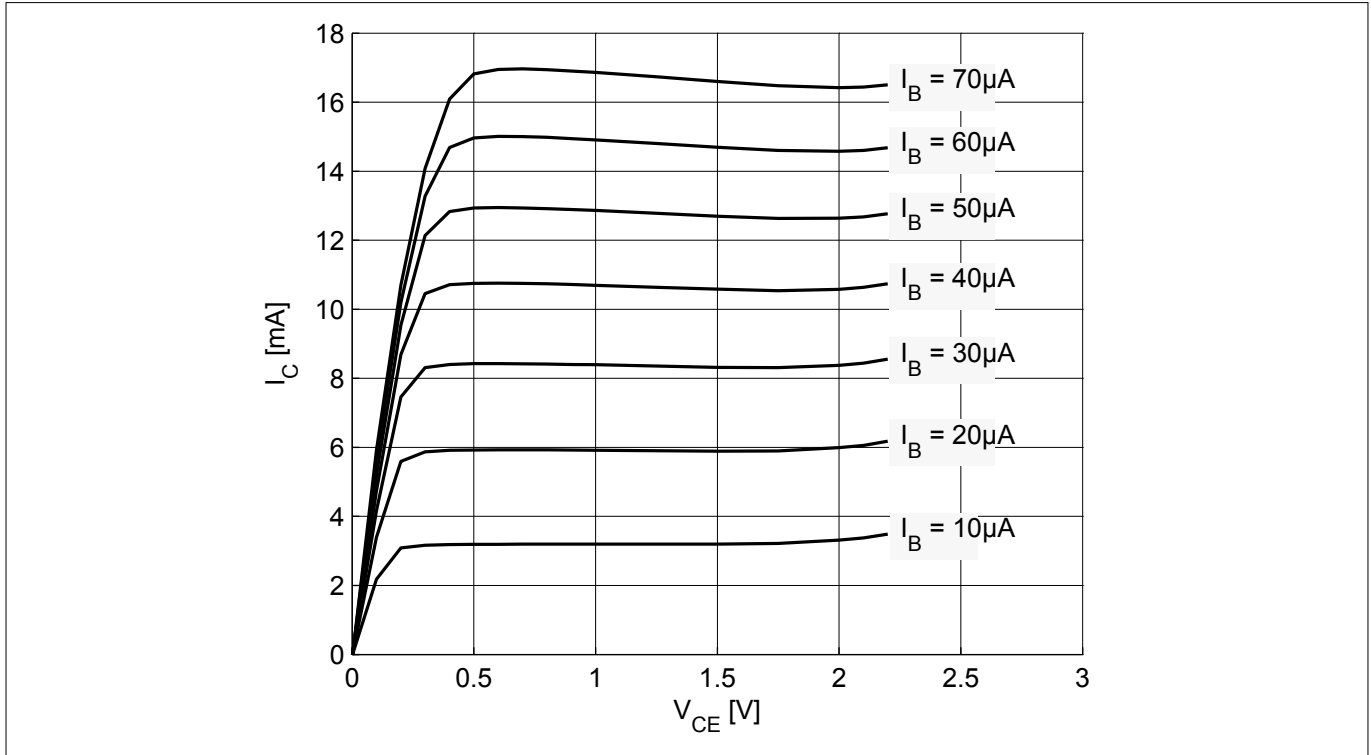
**Table 14 AC characteristics,  $V_{CE} = 1.8 \text{ V}$ ,  $f = 12 \text{ GHz}$**

Parameter	Symbol	Values			Unit	Note or test condition		
		Min.	Typ.	Max.				
Power gain		-		-	dB	$I_C = 10 \text{ mA}$		
<ul style="list-style-type: none"> <li>Maximum power gain</li> <li>Transducer gain</li> </ul>	$G_{ma}$ $ S_{21} ^2$		13.5 10					
Noise figure			-			-	dB	$I_C = 5 \text{ mA}$
<ul style="list-style-type: none"> <li>Minimum noise figure</li> <li>Associated gain</li> </ul>	$NF_{min}$ $G_{ass}$				1.1 12			
Linearity					dBm	$Z_S = Z_L = 50 \Omega$ , $I_C = 10 \text{ mA}$		
<ul style="list-style-type: none"> <li>3rd order intercept point at output</li> <li>1 dB gain compression point at output</li> </ul>	$OIP_3$ $OP_{1dB}$	17 3						

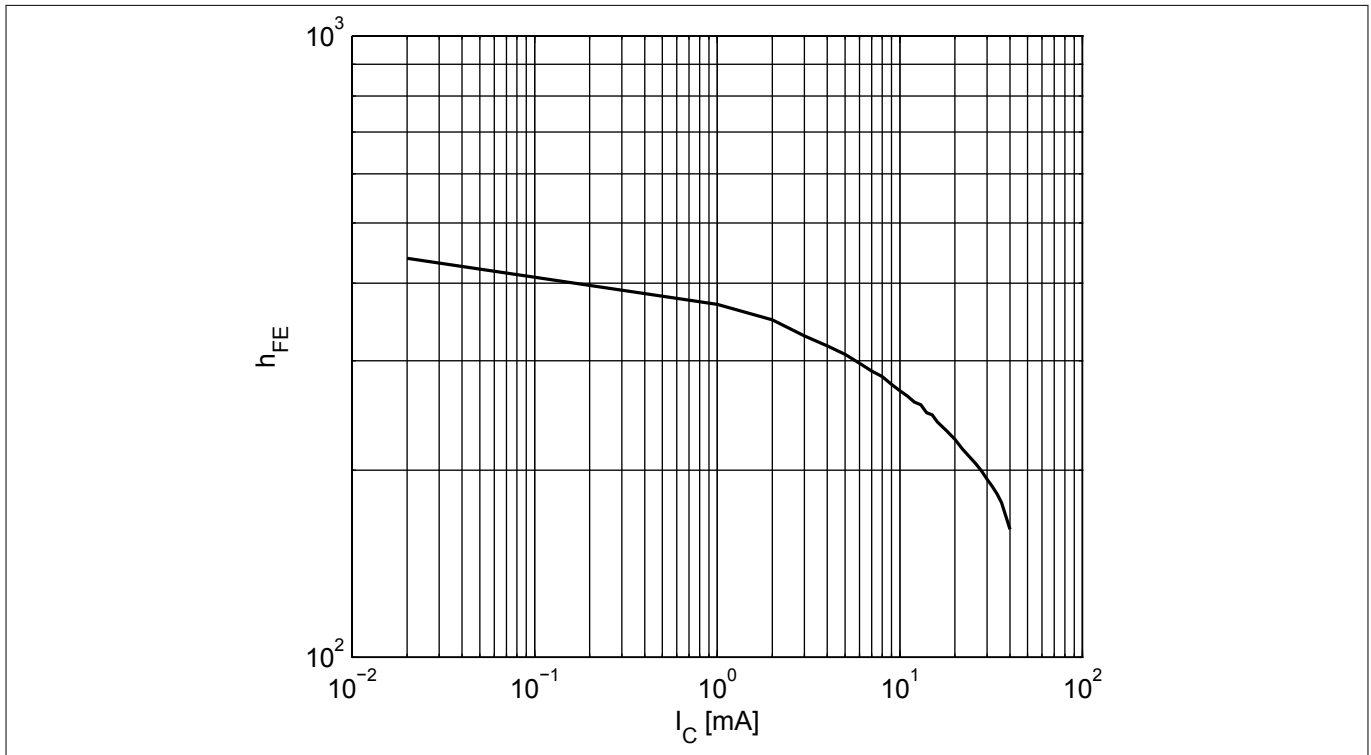
Note:  $G_{ms} = |S_{21}/S_{12}|$  for  $k < 1$ ;  $G_{ma} = |S_{21}/S_{12}|(k(k^2-1)^{1/2})$  for  $k > 1$ . In order to get the  $NF_{min}$  values stated in this chapter the test fixture losses have been subtracted from all measured results.  $OIP_3$  value depends on termination of all intermodulation frequency components. Termination used for this measurement is  $50 \Omega$  from 0.2 MHz to 12 GHz.

**Electrical characteristics**

**3.4 Characteristic DC diagrams**

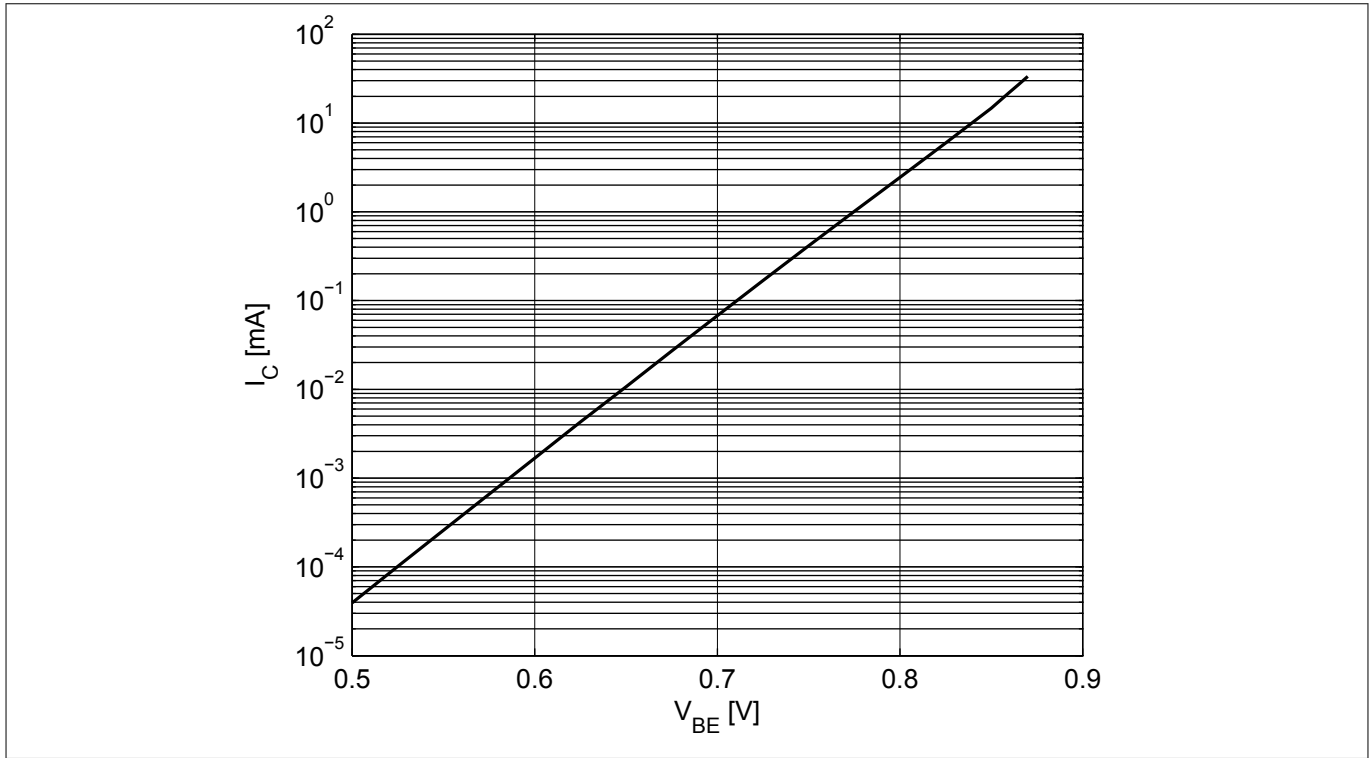


**Figure 3 Collector current vs. collector emitter voltage  $I_C = f(V_{CE})$ ,  $I_B = \text{parameter}$**

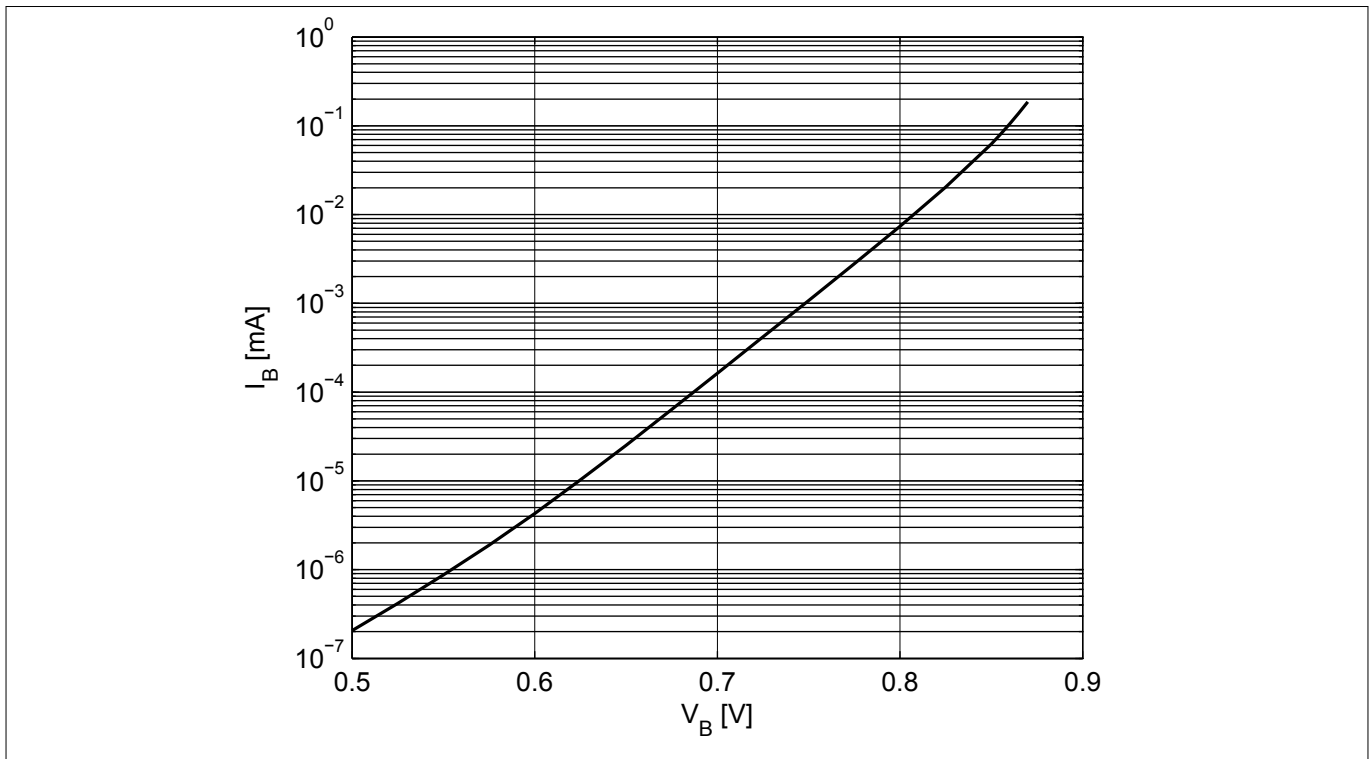


**Figure 4 DC current gain  $h_{FE} = f(I_C)$ ,  $V_{CE} = 1.8 V$**

**Electrical characteristics**

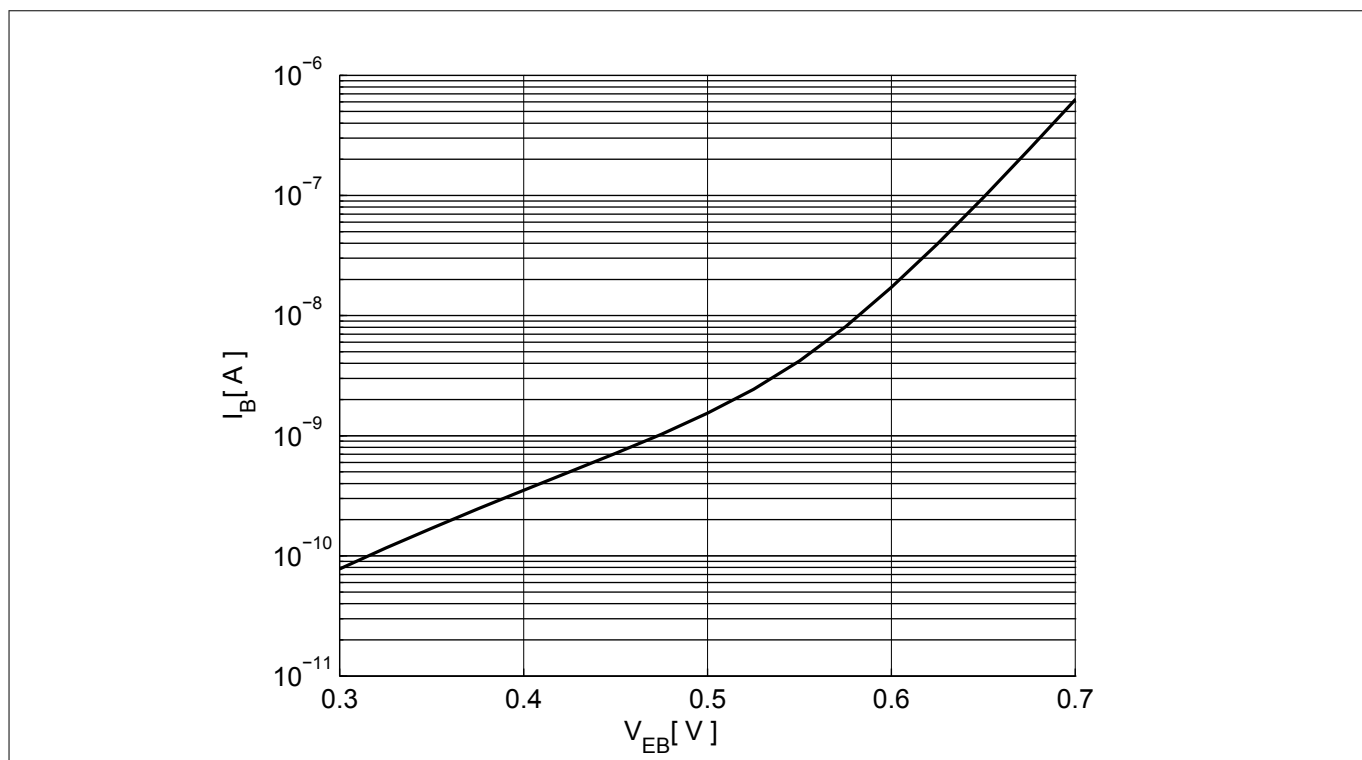


**Figure 5** Collector current vs. base emitter forward voltage  $I_C = f(V_{BE})$ ,  $V_{CE} = 1.8$  V



**Figure 6** Base current vs. base emitter forward voltage  $I_B = f(V_{BE})$ ,  $V_{CE} = 1.8$  V

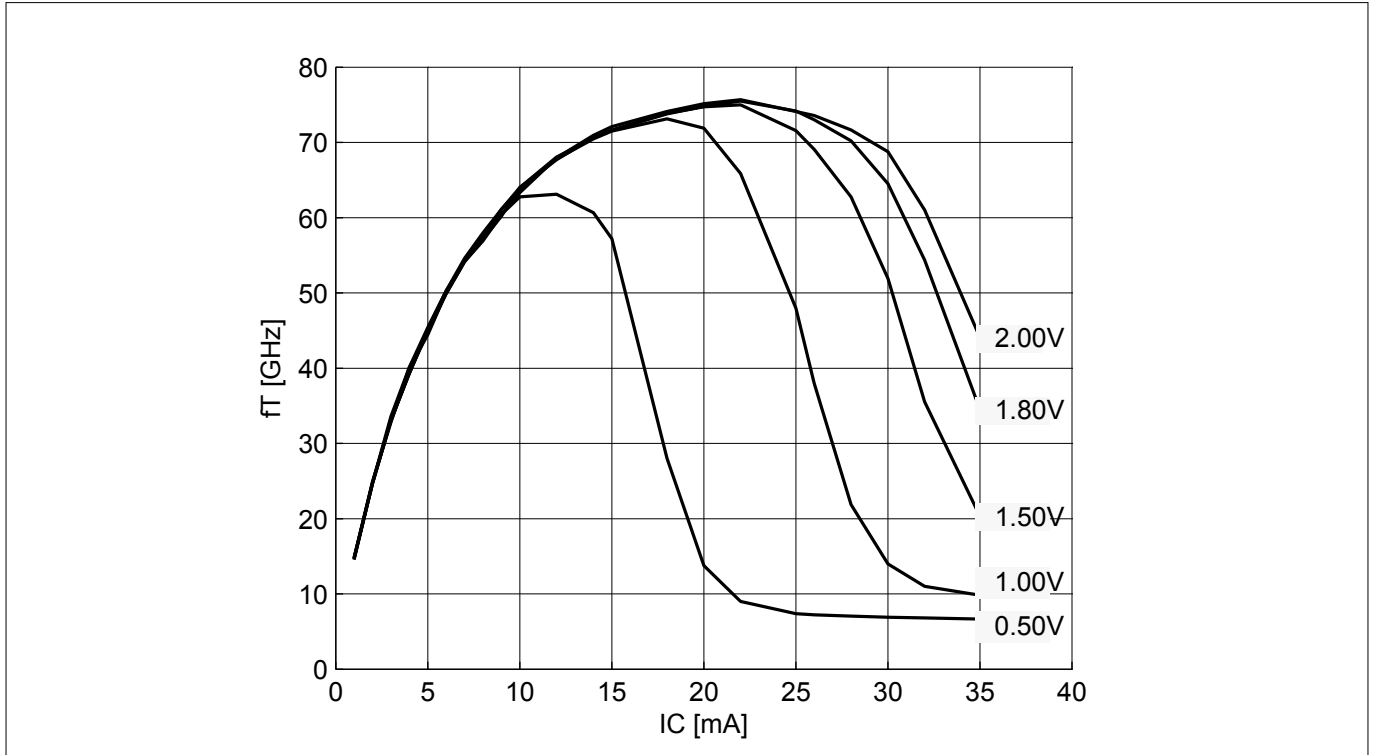
**Electrical characteristics**



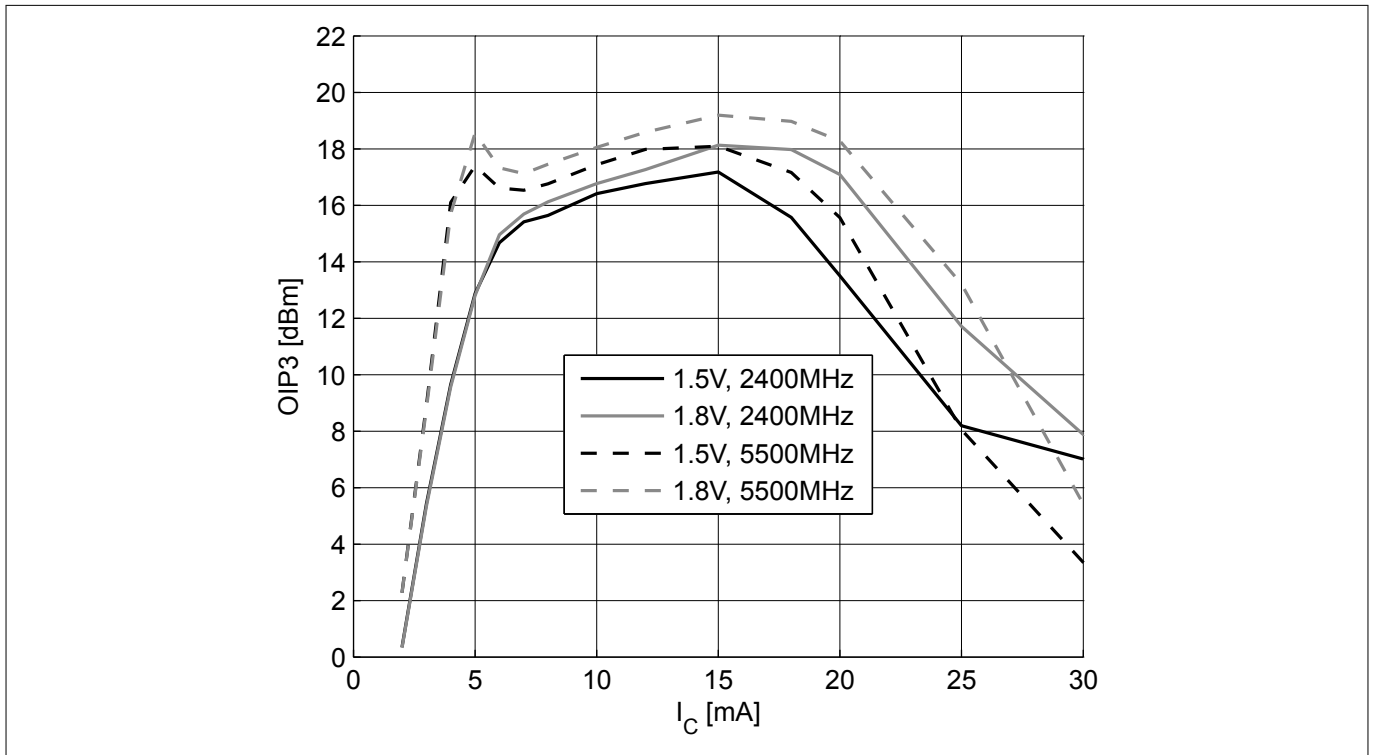
**Figure 7** Base current vs. base emitter reverse voltage  $I_B = f(V_{EB})$ ,  $V_{CE} = 1.8$  V

Electrical characteristics

**3.5 Characteristic AC diagrams**

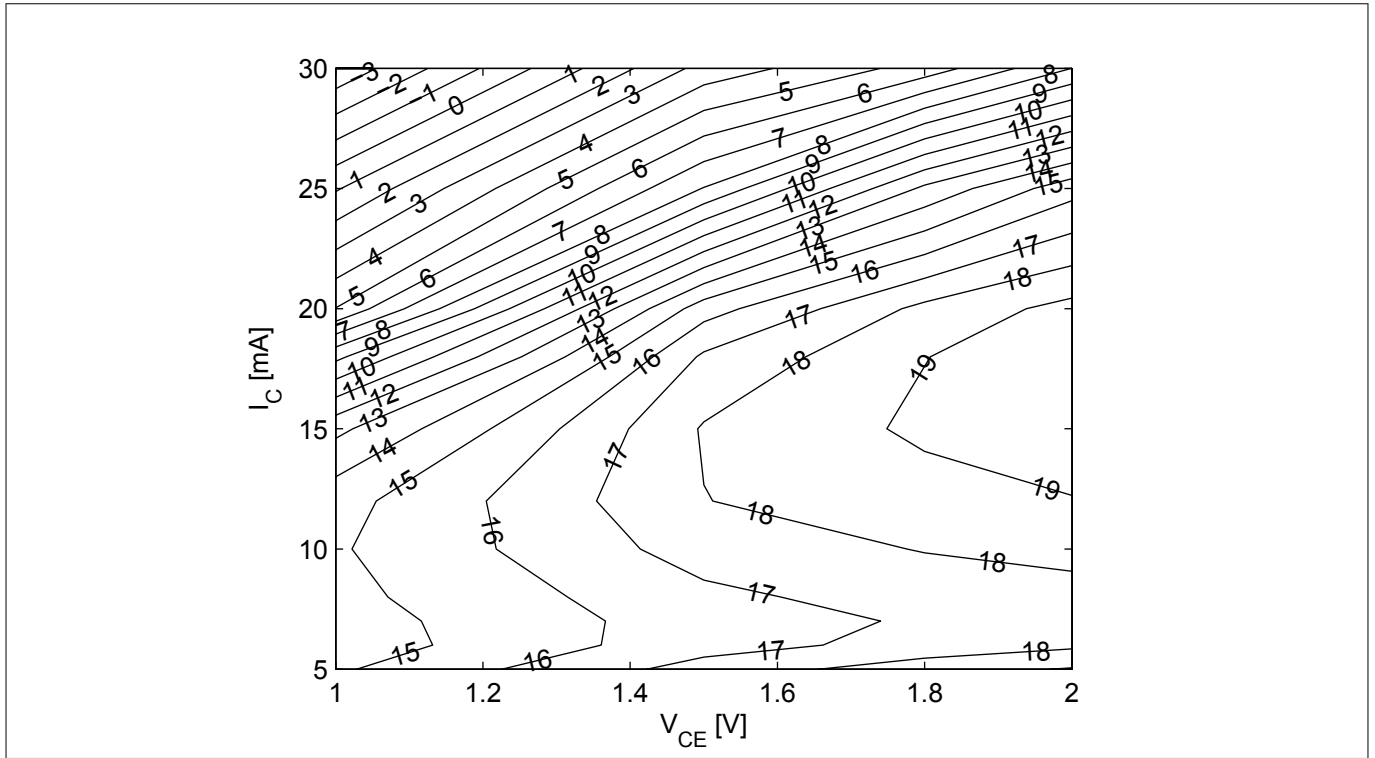


**Figure 8** Transition frequency  $f_T = f(I_C)$ ,  $f = 2 \text{ GHz}$ ,  $V_{CE} = \text{parameter}$

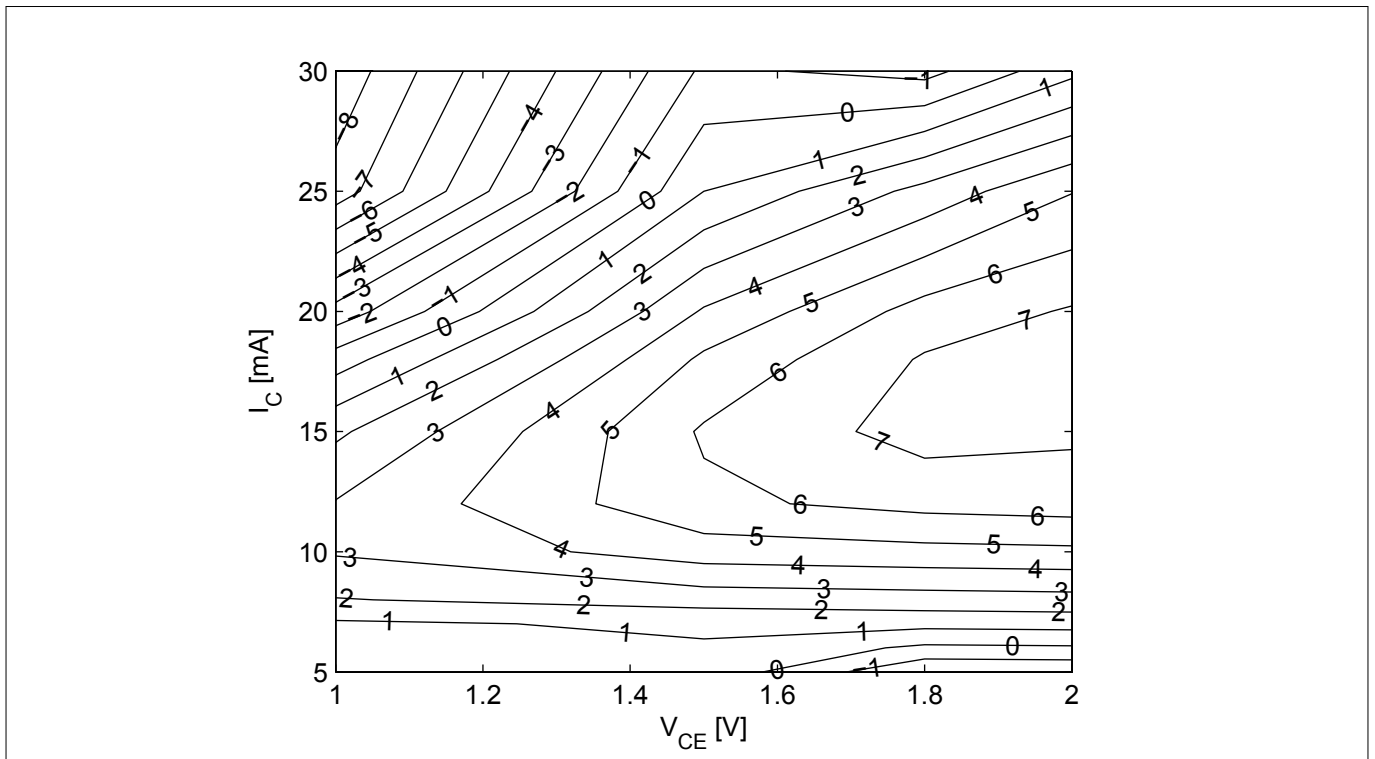


**Figure 9** 3rd order intercept point at output  $OIP_3 = f(I_C)$ ,  $Z_S = Z_L = 50 \Omega$ ,  $V_{CE}$ ,  $f = \text{parameters}$

**Electrical characteristics**

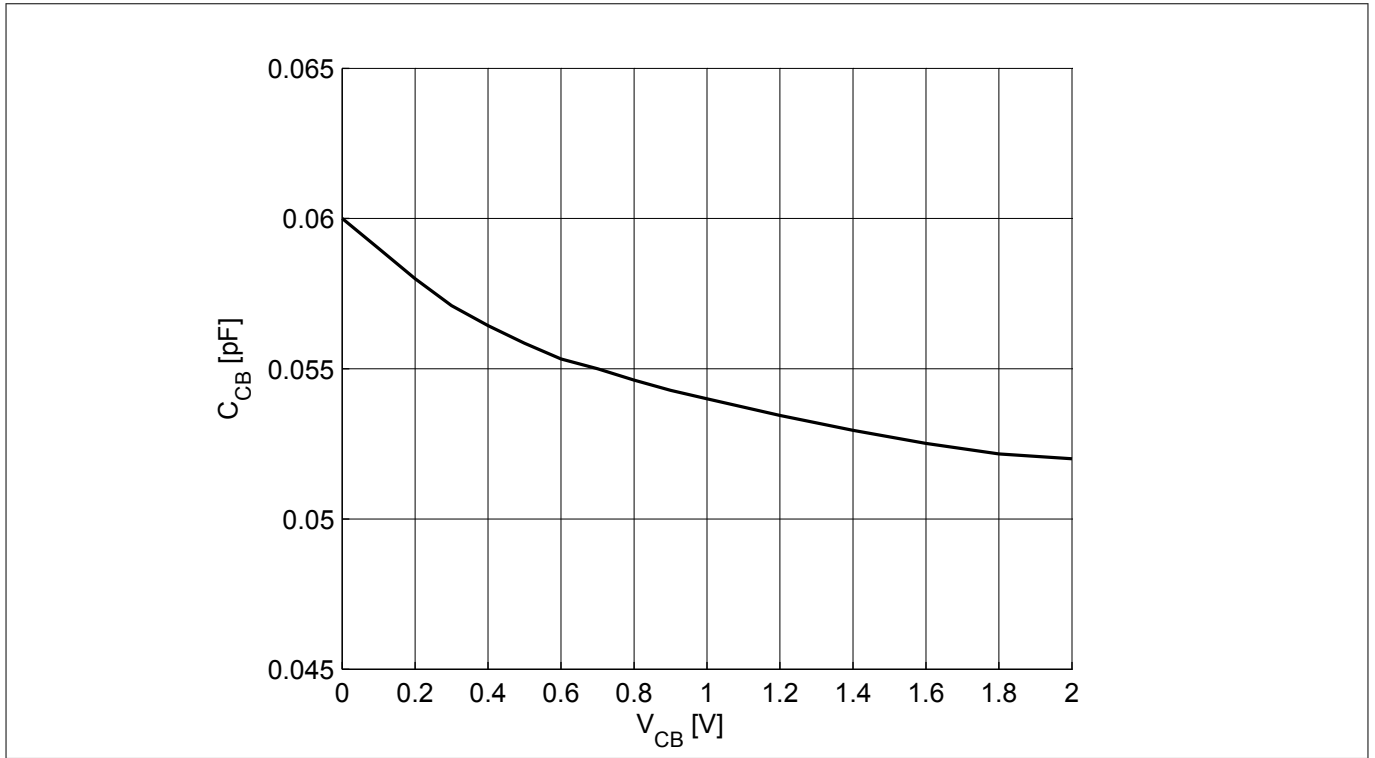


**Figure 10** 3rd order intercept point at output  $OIP_3$  [dBm] =  $f(I_C, V_{CE})$ ,  $Z_S = Z_L = 50 \Omega$ ,  $f = 5.5$  GHz

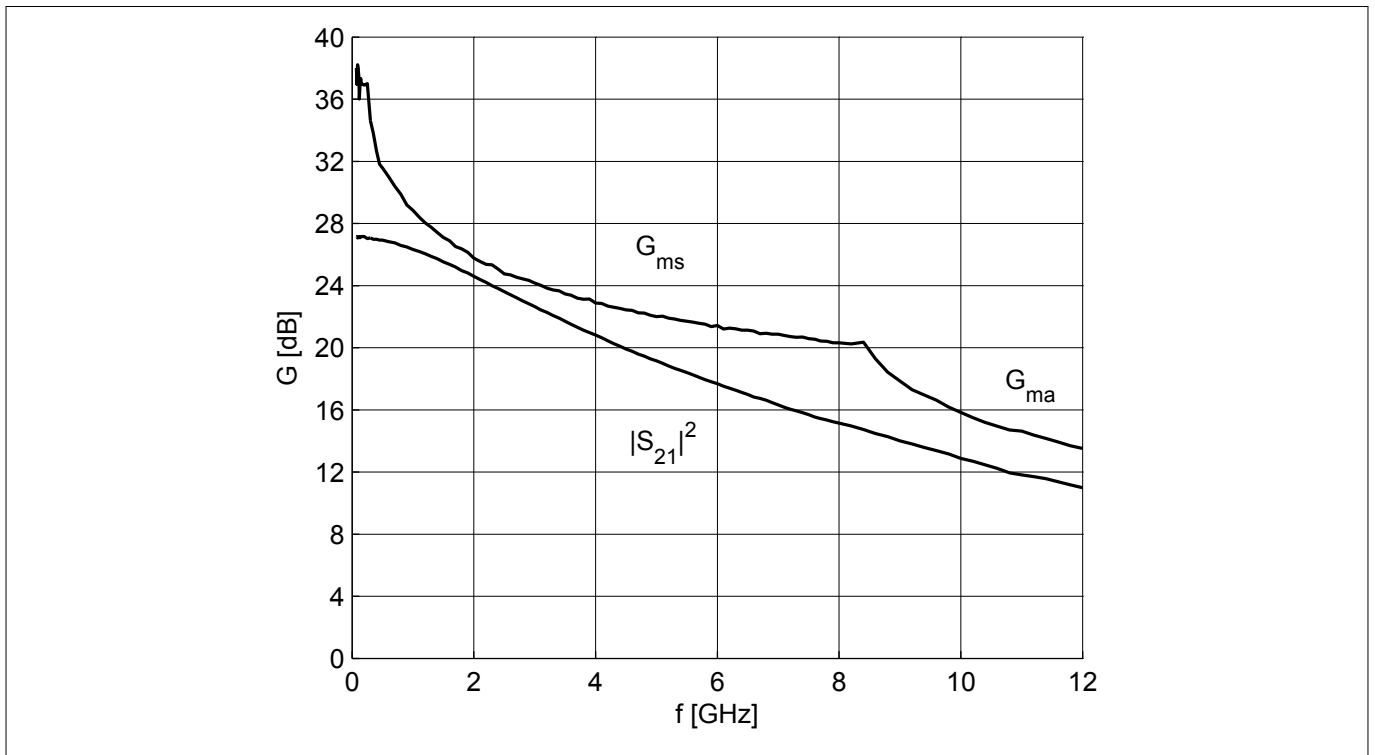


**Figure 11** Compression point at output  $OP_{1dB}$  [dBm] =  $f(I_C, V_{CE})$ ,  $Z_S = Z_L = 50 \Omega$ ,  $f = 5.5$  GHz

**Electrical characteristics**

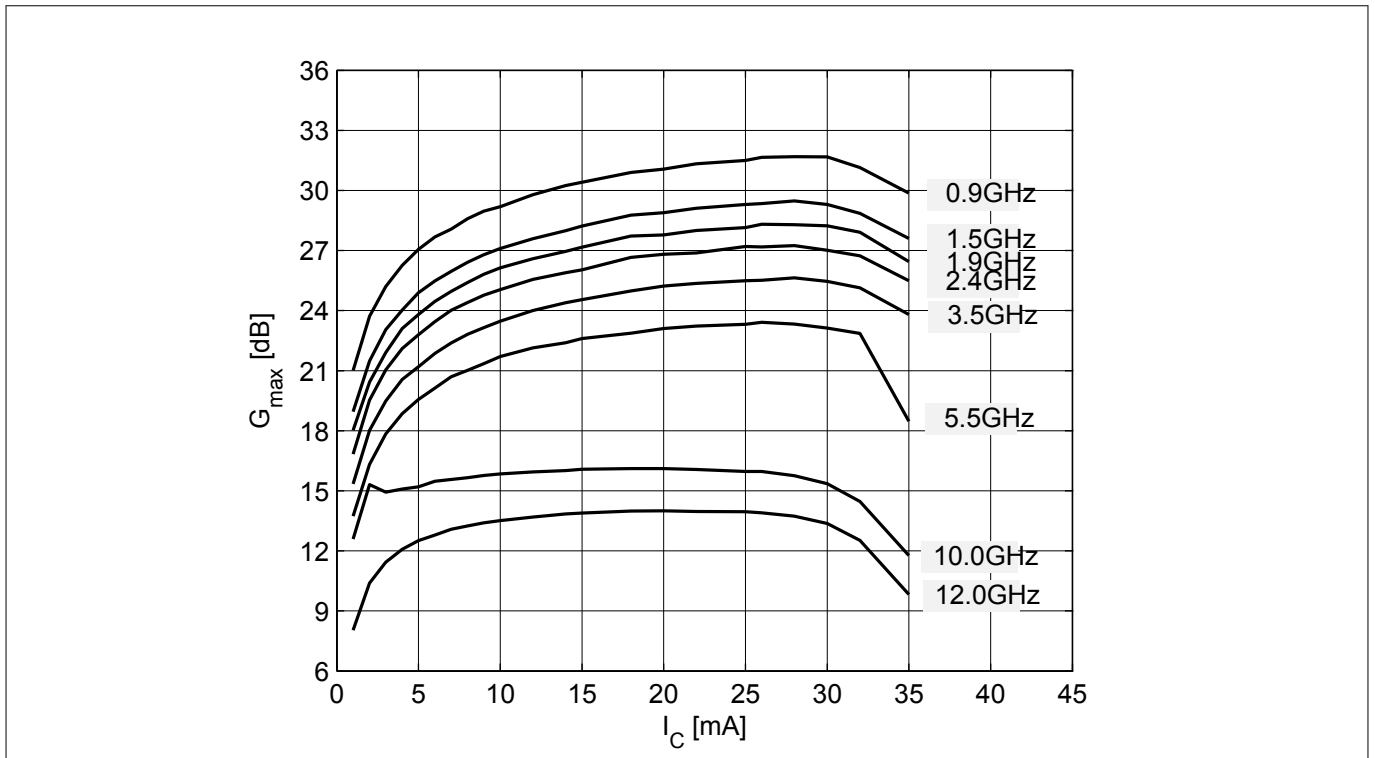


**Figure 12** Collector base capacitance  $C_{CB} = f(V_{CB})$ ,  $f = 1$  MHz

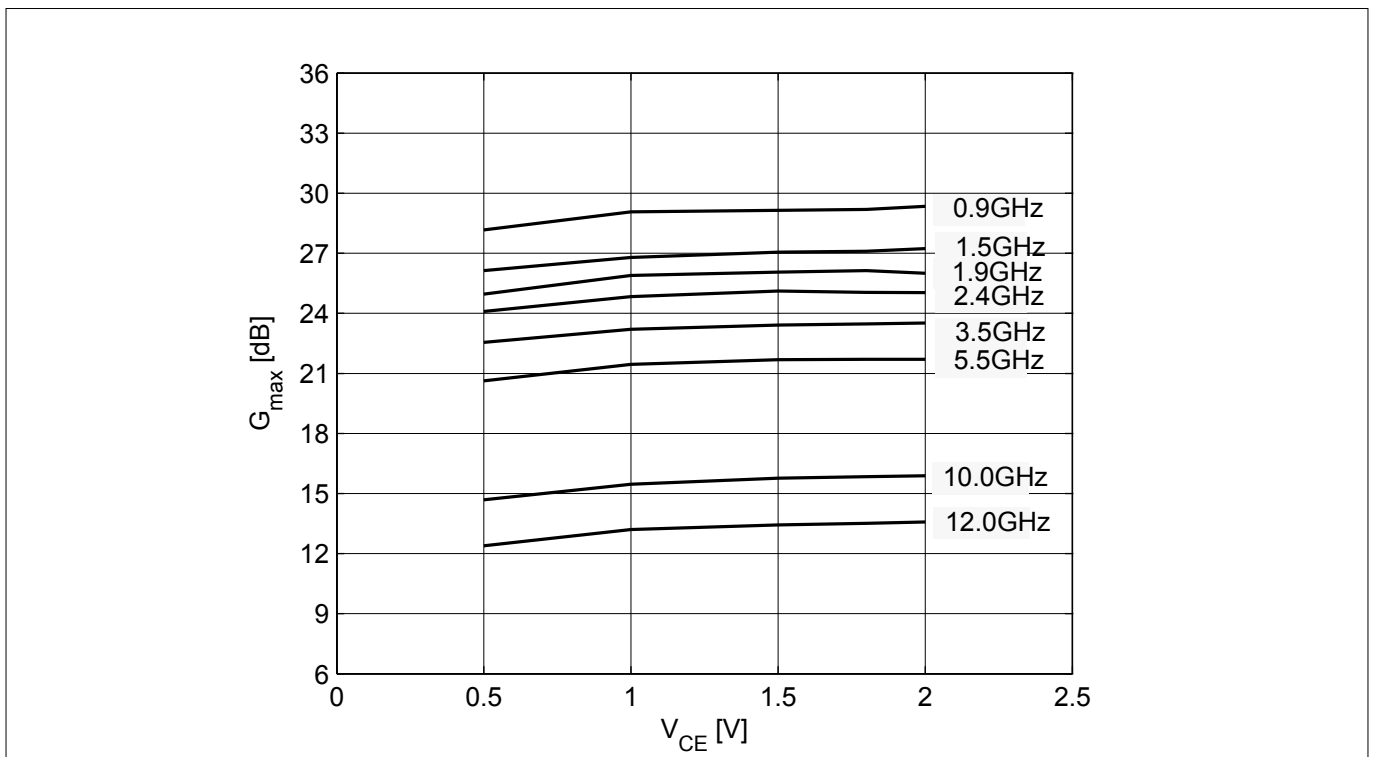


**Figure 13** Gain  $G_{ma}$ ,  $G_{ms}$ ,  $|S_{21}|^2 = f(f)$ ,  $V_{CE} = 1.8$  V,  $I_C = 10$  mA

**Electrical characteristics**



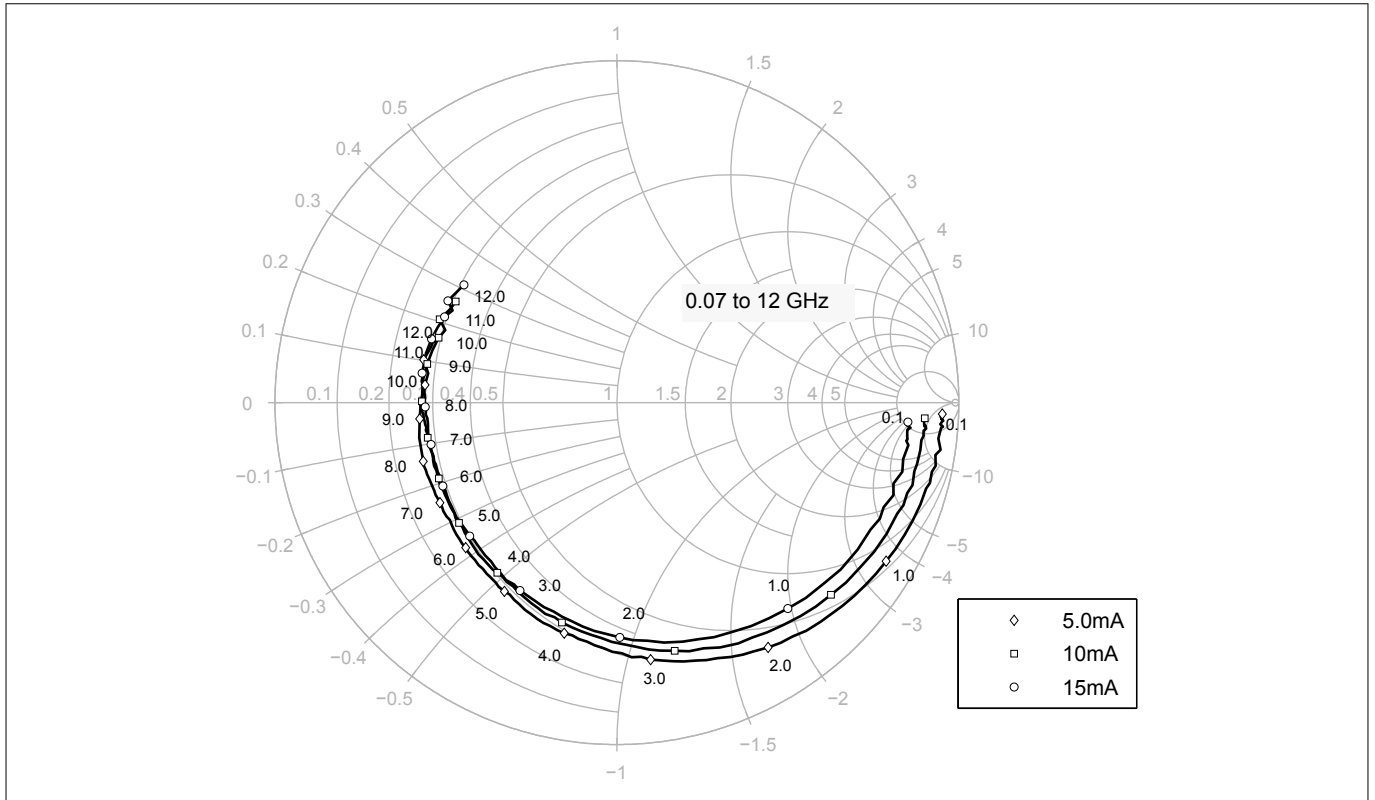
**Figure 14** Maximum power gain  $G_{max} = f(I_C)$ ,  $V_{CE} = 1.8\text{ V}$ ,  $f =$  parameter in GHz



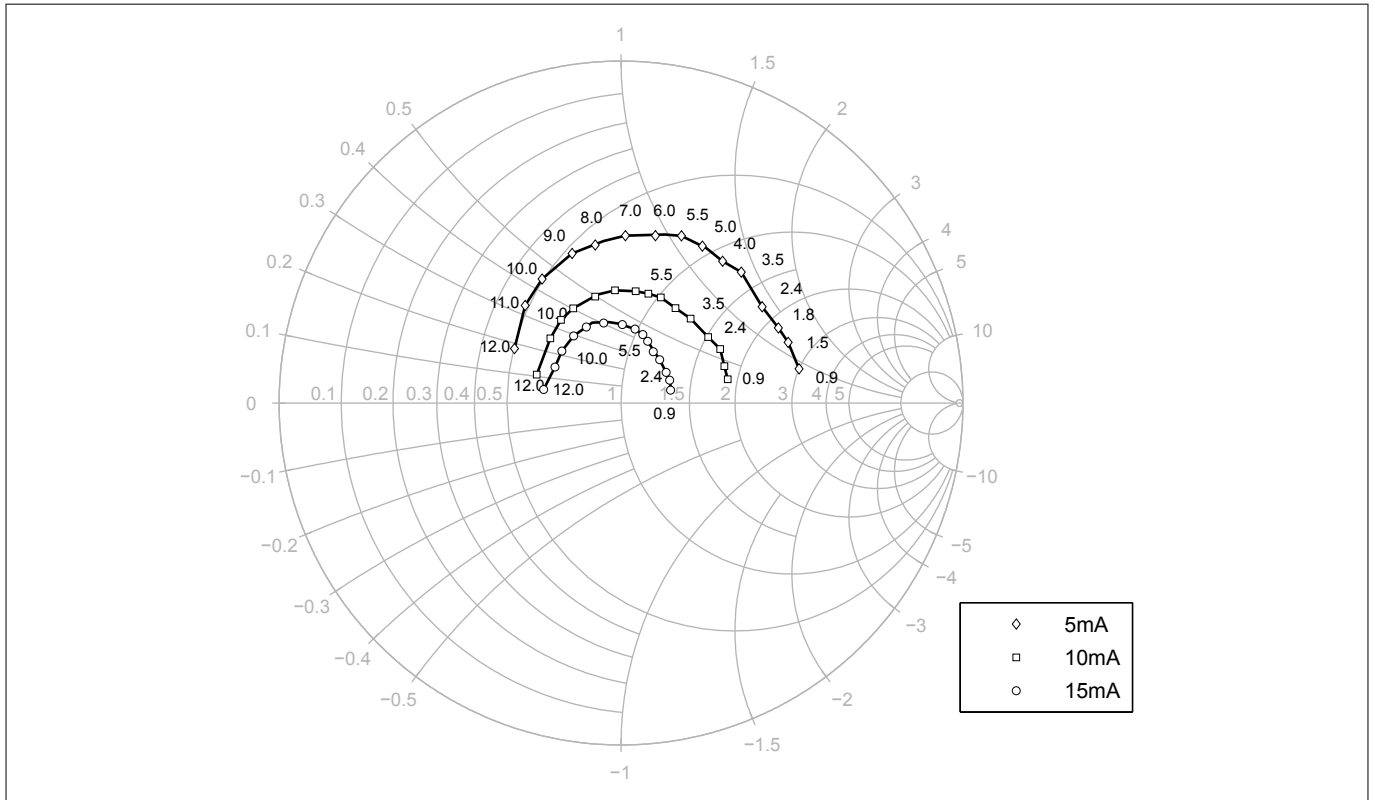
**Figure 15** Maximum power gain  $G_{max} = f(V_{CE})$ ,  $I_C = 10\text{ mA}$ ,  $f =$  parameter in GHz



**Electrical characteristics**

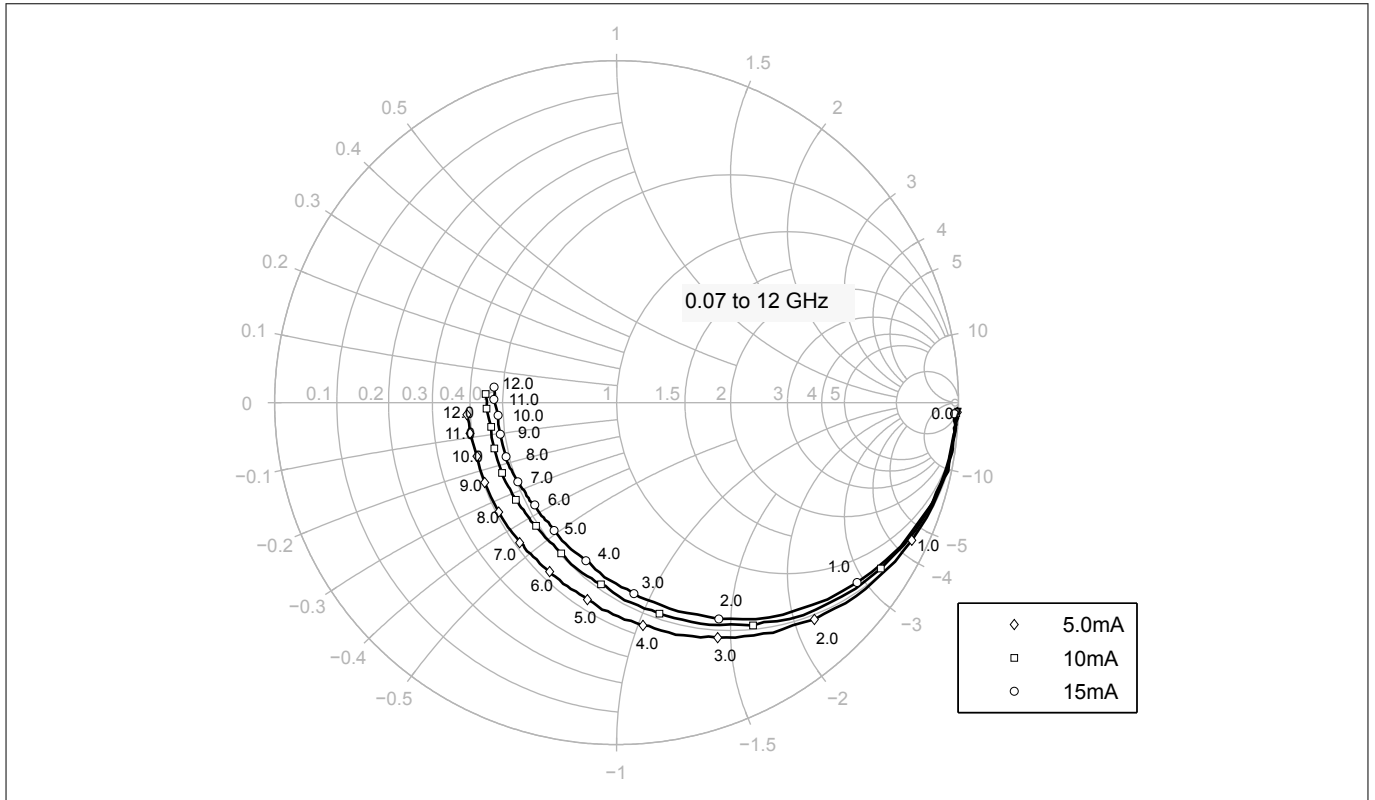


**Figure 16** Input reflection coefficient  $S_{11} = f(f)$ ,  $V_{CE} = 1.8 \text{ V}$ ,  $I_C = 5 / 10 / 15 \text{ mA}$

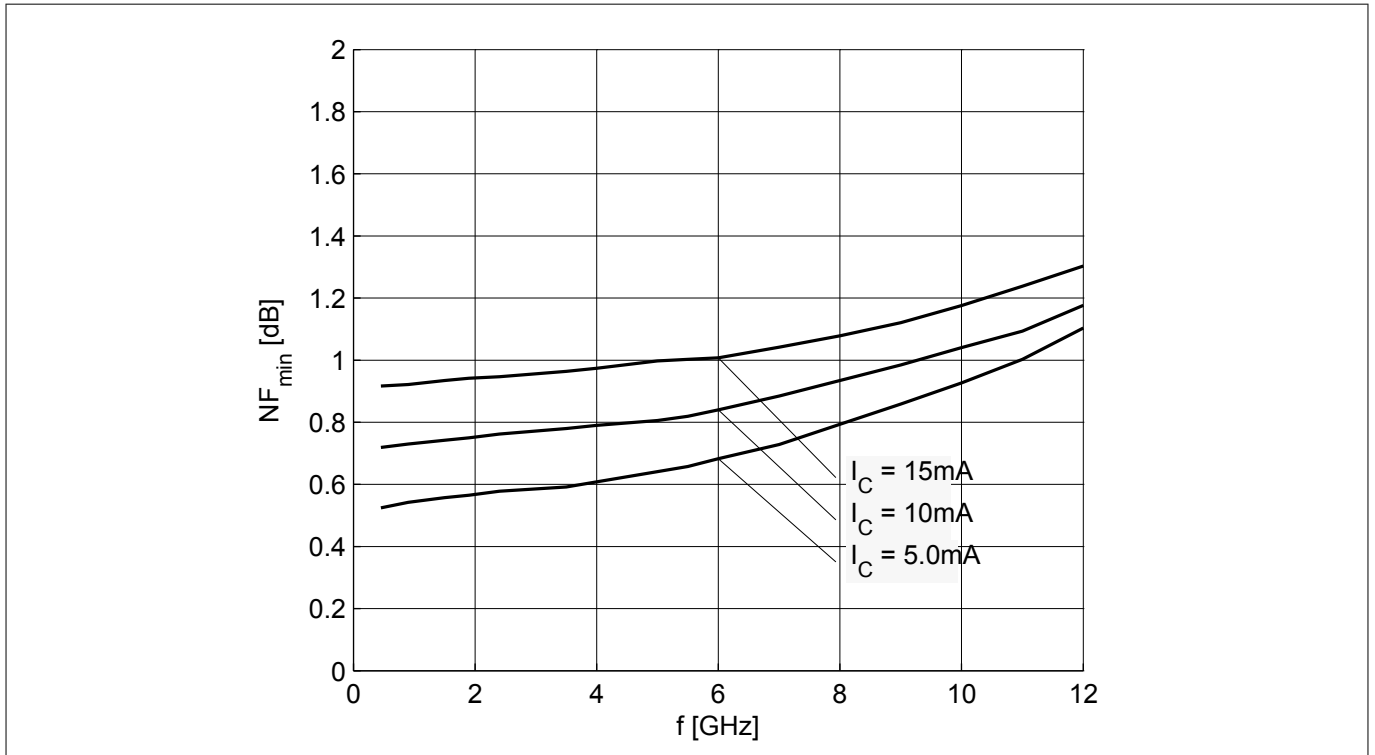


**Figure 17** Source impedance for minimum noise figure  $Z_{s,opt} = f(f)$ ,  $V_{CE} = 1.8 \text{ V}$ ,  $I_C = 5 / 10 / 15 \text{ mA}$

**Electrical characteristics**

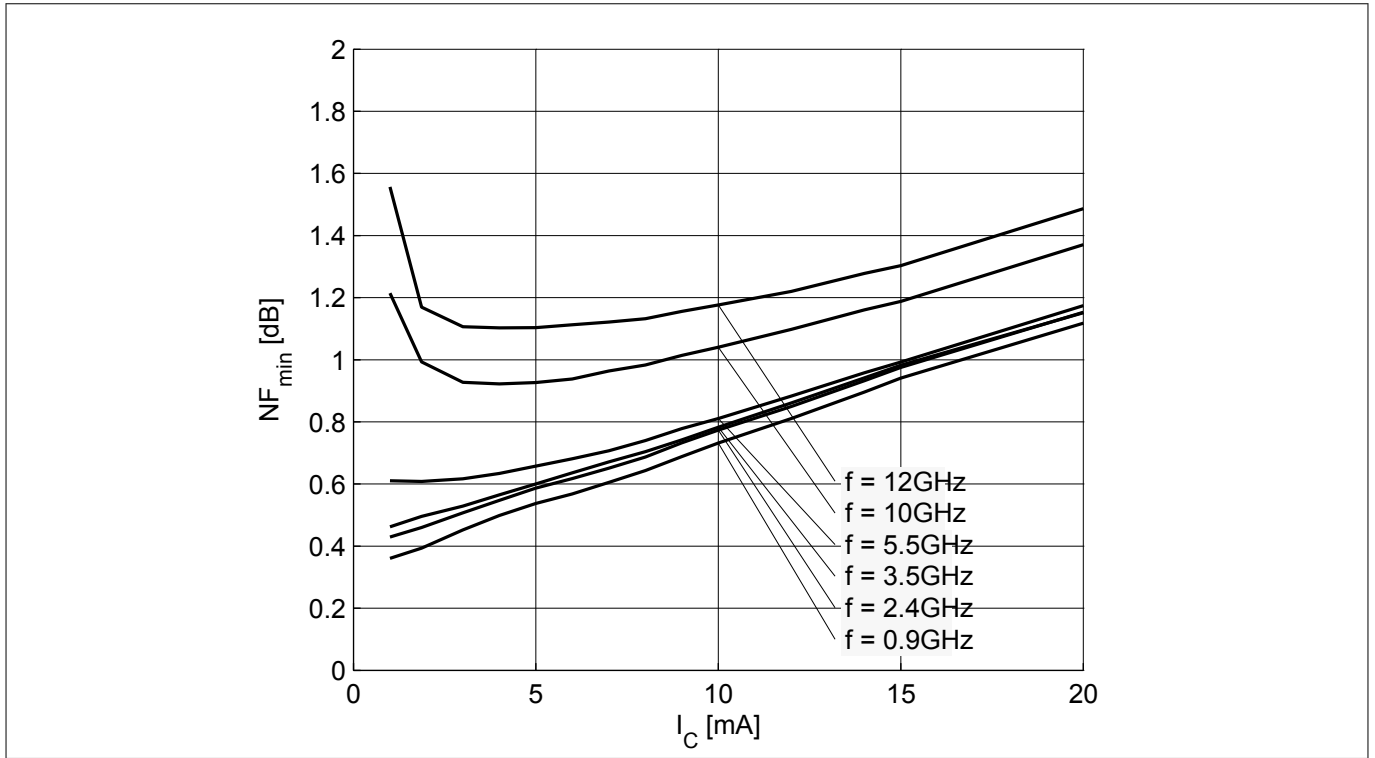


**Figure 18** Output reflection coefficient  $S_{22} = f(f)$ ,  $V_{CE} = 1.8 \text{ V}$ ,  $I_C = 5 / 10 / 15 \text{ mA}$

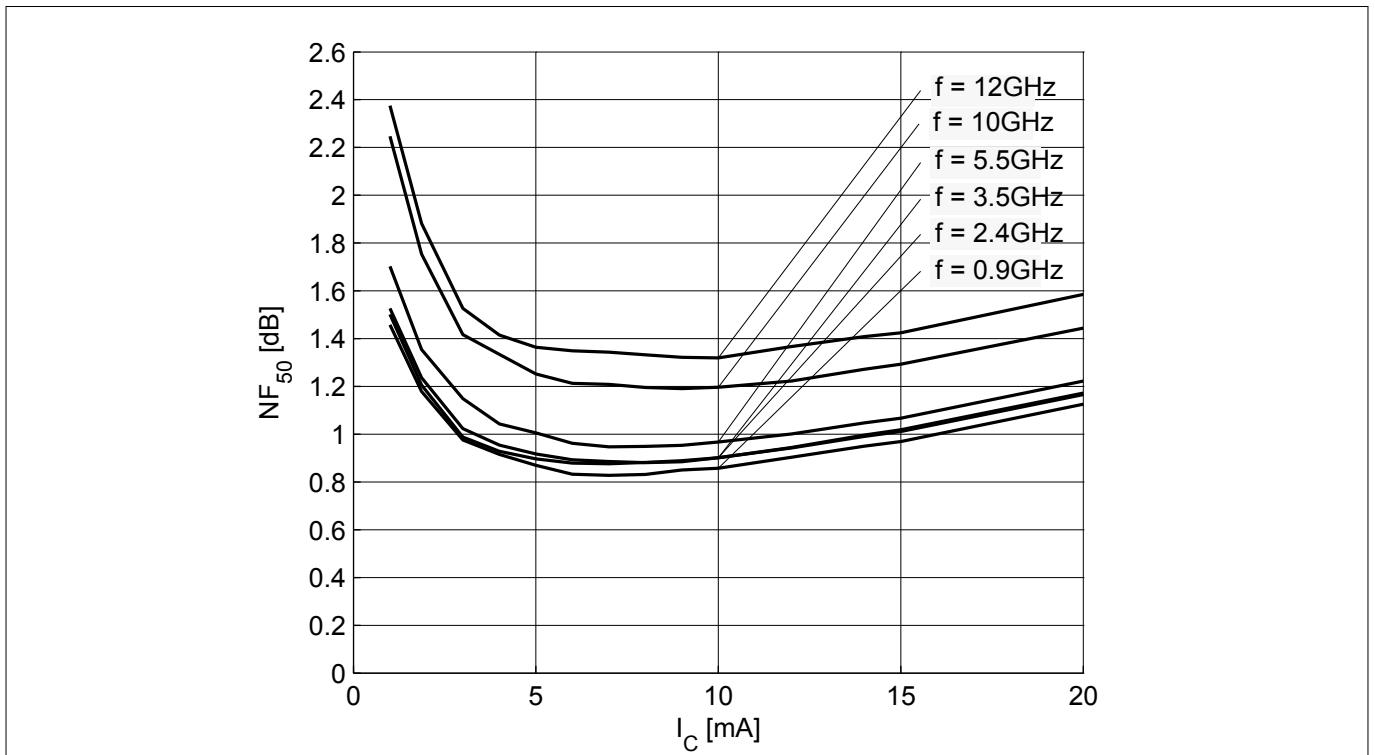


**Figure 19** Noise figure  $NF_{min} = f(f)$ ,  $V_{CE} = 1.8 \text{ V}$ ,  $Z_S = Z_{S,opt}$ ,  $I_C = 5 / 10 / 15 \text{ mA}$

**Electrical characteristics**



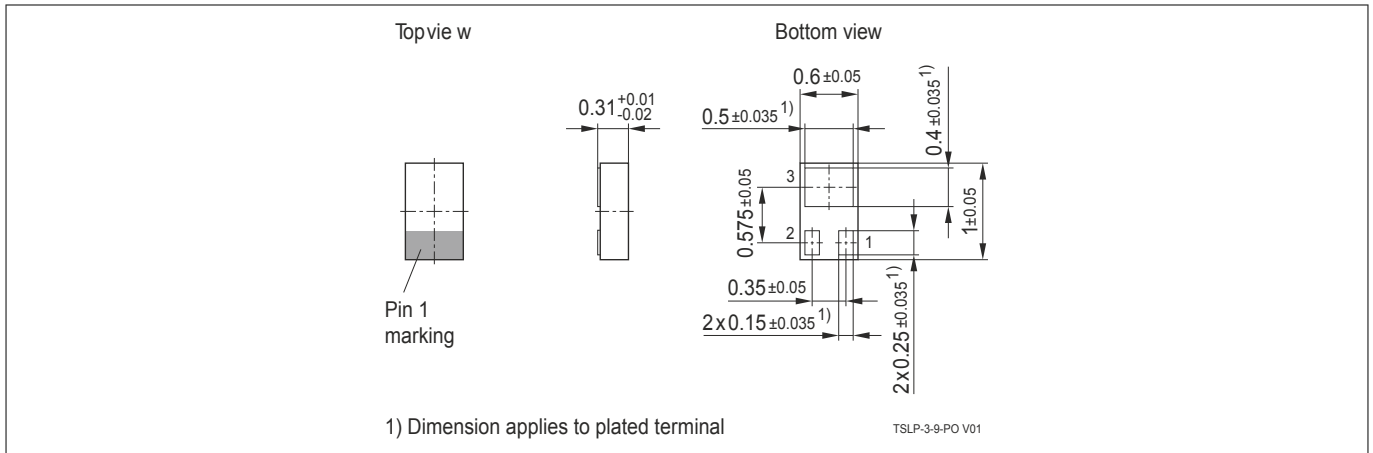
**Figure 20** Noise figure  $NF_{min} = f(I_C)$ ,  $V_{CE} = 1.8\text{ V}$ ,  $Z_S = Z_{S,opt}$ ,  $f =$  parameter in GHz



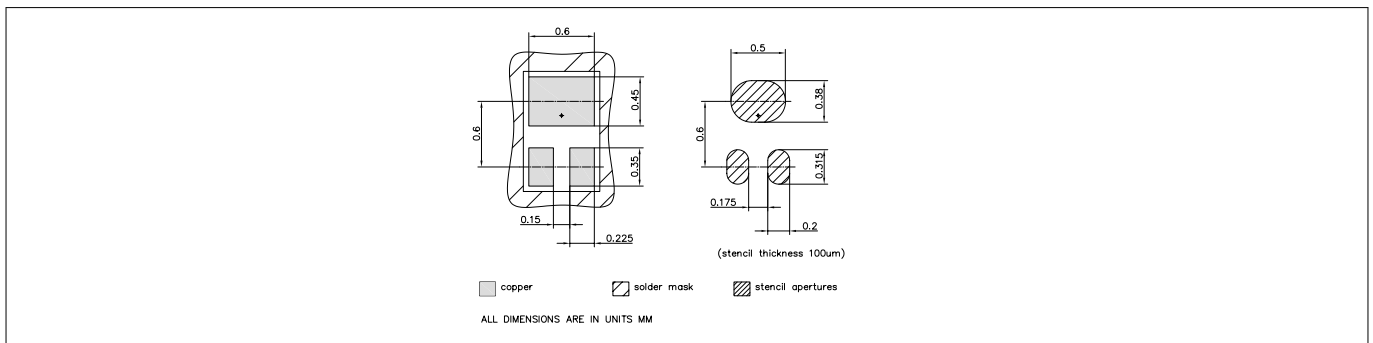
**Figure 21** Noise figure  $NF_{50} = f(I_C)$ ,  $V_{CE} = 1.8\text{ V}$ ,  $Z_S = 50\ \Omega$ ,  $f =$  parameter in GHz

*Note:* The curves shown in this chapter have been generated using typical devices but shall not be considered as a guarantee that all devices have identical characteristic curves.  $T_A = 25\text{ }^\circ\text{C}$ .

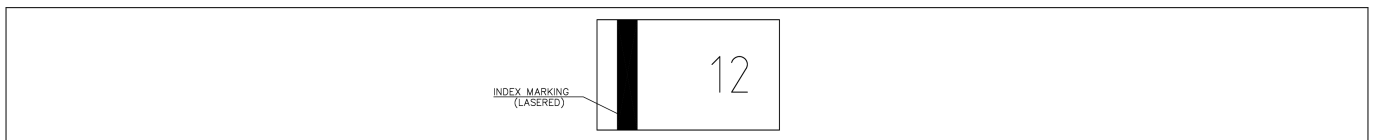
## 4 Package information TSLP-3-9



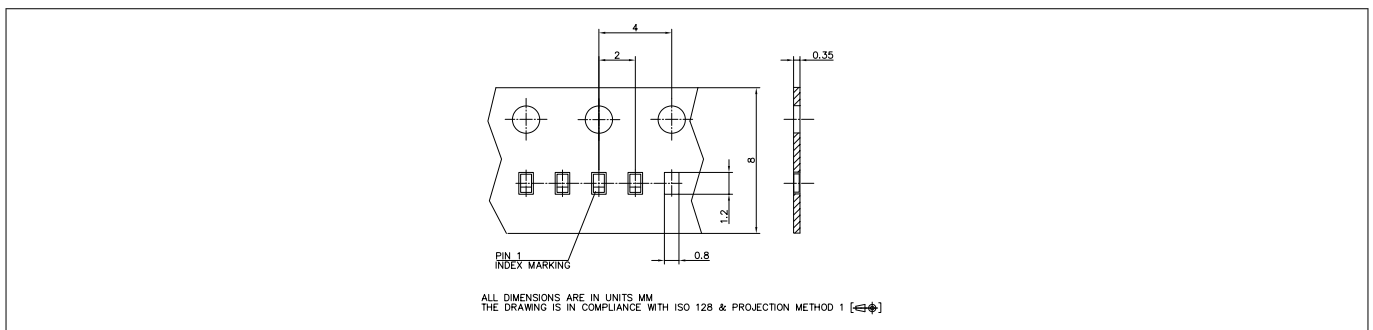
**Figure 22** Package outline (dimension in mm)



**Figure 23** Foot print



**Figure 24** Marking layout example



**Figure 25** Tape dimensions

*Note:* See our [Recommendations for Printed Circuit Board Assembly of TSLP/TSSLP/TSNP Packages](#). The marking layout is an example. For the real marking code refer to the device information on the first page. The number of characters shown in the layout example is not necessarily the real one. The marking layout can consist of less characters.

---

Revision history

## Revision history

Document version	Date of release	Description of changes
2.0	2018-09-26	New datasheet layout.

## Trademarks

All referenced product or service names and trademarks are the property of their respective owners.

**Edition 2018-09-26**

**Published by**  
**Infineon Technologies AG**  
**81726 Munich, Germany**

**© 2018 Infineon Technologies AG**  
**All Rights Reserved.**

**Do you have a question about any**  
**aspect of this document?**  
**Email: [erratum@infineon.com](mailto:erratum@infineon.com)**

**Document reference**  
**IFX-omc1516357760828**

## IMPORTANT NOTICE

The information given in this document shall in no event be regarded as a guarantee of conditions or characteristics ("Beschaffheitsgarantie").

With respect to any examples, hints or any typical values stated herein and/or any information regarding the application of the product, Infineon Technologies hereby disclaims any and all warranties and liabilities of any kind, including without limitation warranties of non-infringement of intellectual property rights of any third party.

In addition, any information given in this document is subject to customer's compliance with its obligations stated in this document and any applicable legal requirements, norms and standards concerning customer's products and any use of the product of Infineon Technologies in customer's applications.

The data contained in this document is exclusively intended for technically trained staff. It is the responsibility of customer's technical departments to evaluate the suitability of the product for the intended application and the completeness of the product information given in this document with respect to such application.

## WARNINGS

Due to technical requirements products may contain dangerous substances. For information on the types in question please contact your nearest Infineon Technologies office.

Except as otherwise explicitly approved by Infineon Technologies in a written document signed by authorized representatives of Infineon Technologies, Infineon Technologies' products may not be used in any applications where a failure of the product or any consequences of the use thereof can reasonably be expected to result in personal injury