



2SC5353B

NPN SILICON TRANSISTOR

HIGH VOLTAGE NPN TRANSISTOR

■ DESCRIPTION

Switching Regulator and High Voltage Switching Applications
High-Speed DC-DC Converter Applications

■ FEATURES

- * Excellent switching times: $t_R = 0.7\mu s_{(MAX)}$, $t_F = 0.5\mu s_{(MAX)}$
- * High collectors breakdown voltage: $V_{CE0} = 750V$

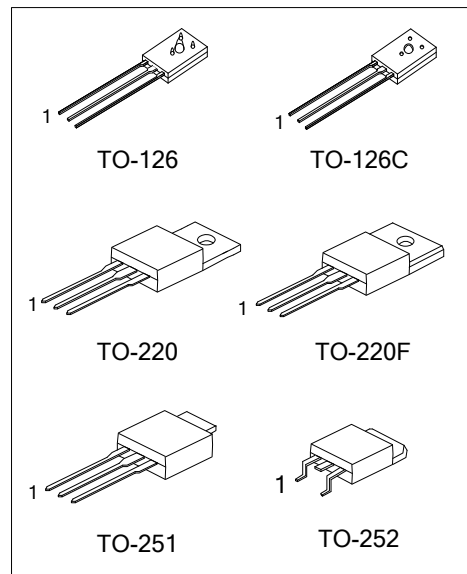

■ ORDERING INFORMATION

Ordering Number		Package	Pin Assignment			Packing
Lead Free	Halogen Free		1	2	3	
2SC5353BL-T60-K	2SC5353BG-T60-K	TO-126	B	C	E	Bulk
2SC5353BL-T6C-K	2SC5353BG-T6C-K	TO-126C	B	C	E	Bulk
2SC5353BL-TA3-T	2SC5353BG-TA3-T	TO-220	B	C	E	Tube
2SC5353BL-TF3-T	2SC5353BG-TF3-T	TO-220F	B	C	E	Tube
2SC5353BL-TM3-T	2SC5353BG-TM3-T	TO-251	B	C	E	Tube
2SC5353BL-TN3-R	2SC5353BG-TN3-R	TO-252	B	C	E	Tape Reel

<p>2SC5353BL-TA3-T</p> <p>(1)Packing Type (2)Package Type (3)Lead Free</p>	<p>(1) K: Bulk, T: Tube, R: Tape Reel (2) T60: TO-126, T6C: TO-126C, TA3: TO-220, TF3: TO-220F, TM3: TO-251, TN3: TO-252 (3) G: Halogen Free, L: Lead Free</p>
--	--

■ ABSOLUTE MAXIMUM RATINGS ($T_C = 25^\circ\text{C}$ unless otherwise specified)

PARAMETER		SYMBOL	RATINGS	UNIT
Collector-Base Voltage		V_{CBO}	900	V
Collector-Emitter Voltage		V_{CEO}	750	V
Emitter-Base Voltage		V_{EBO}	7	V
Collector Current	DC	I_C	3	A
	Pulse	I_{CP}	5	A
Base Current		I_B	1	A
Power Dissipation	TO-220F/TO-126/TO-126C	P_D	20	W
	TO-220		25	W
	TO-251/TO-252		22	W
Junction Temperature		T_J	+150	$^\circ\text{C}$
Storage Temperature		T_{STG}	-40 ~ +150	$^\circ\text{C}$

Note: Absolute maximum ratings are those values beyond which the device could be permanently damaged. Absolute maximum ratings are stress ratings only and functional device operation is not implied.

■ ELECTRICAL CHARACTERISTICS ($T_C = 25^\circ\text{C}$ unless otherwise specified)

PARAMETER		SYMBOL	TEST CONDITIONS	MIN	TYP	MAX	UNIT
Collector-Base Breakdown Voltage		BV_{CBO}	$I_C=1\text{ mA}, I_E=0$	900			V
Collector-Emitter Breakdown Voltage		BV_{CEO}	$I_C=10\text{ mA}, I_B=0$	750			V
Collector Cut-off Current		I_{CBO}	$V_{CB}=720\text{ V}, I_E=0$			100	μA
Emitter Cut-off Current		I_{EBO}	$V_{EB}=7\text{ V}, I_C=0$			10	μA
DC Current Gain		h_{FE1}	$V_{CE}=5\text{ V}, I_C=1\text{ mA}$	10			
		h_{FE2}	$V_{CE}=5\text{ V}, I_C=0.15\text{ A}$	15			
Collector-Emitter Saturation Voltage		$V_{CE(SAT)}$	$I_C=1.2\text{ A}, I_B=0.24\text{ A}$			1.0	V
Base-Emitter Saturation Voltage		$V_{BE(SAT)}$	$I_C=1.2\text{ A}, I_B=0.24\text{ A}$			1.3	V
Switching Time	Rise Time	t_R				0.7	μS
	Storage Time	t_{STG}				4.0	μS
	Fall Time	t_F		$I_{B1} = 0.24\text{ A}, I_{B2} = -0.48\text{ A},$ duty cycle $\leq 1\%$			0.5

TYPICAL CHARACTERISTICS

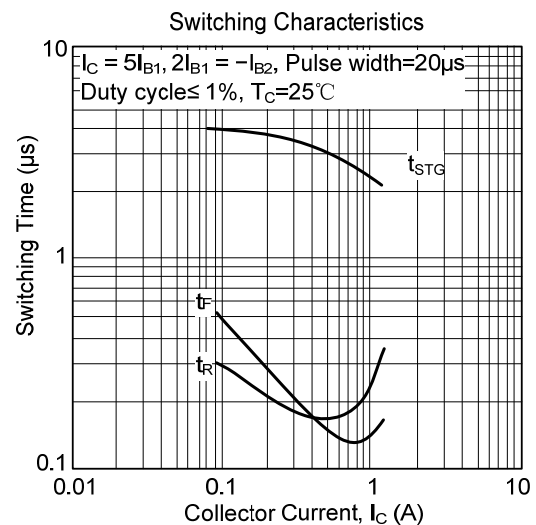
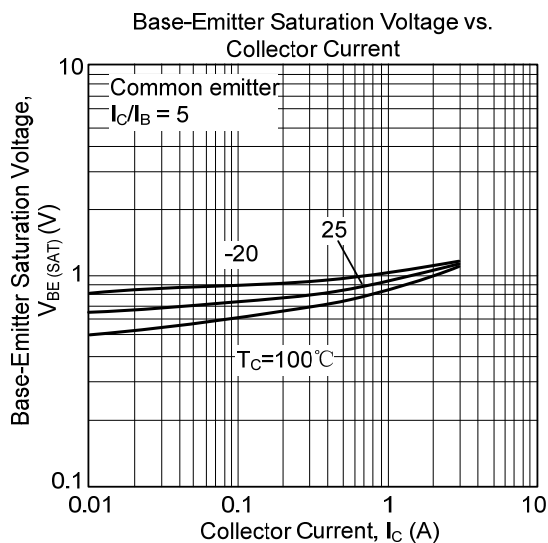
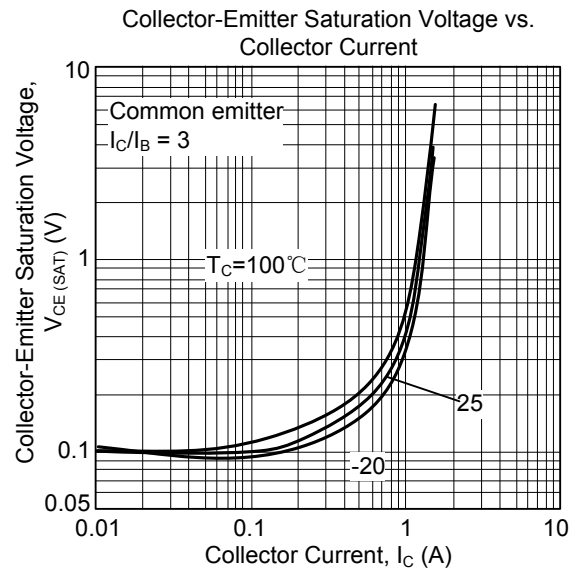
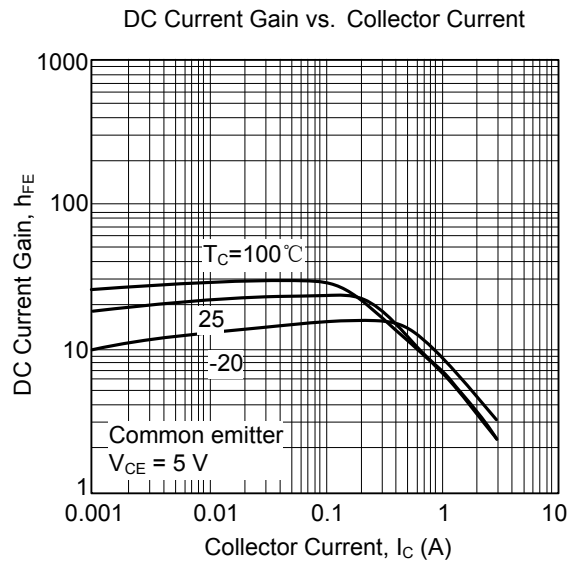
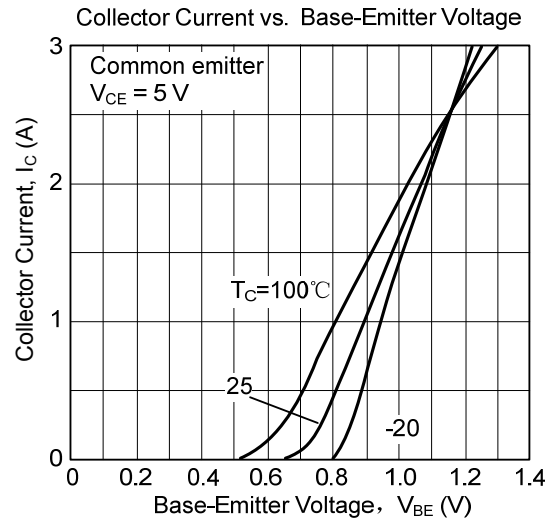
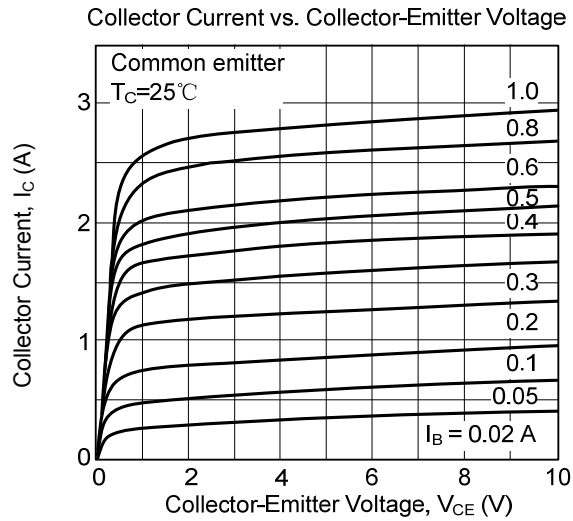

■ TYPICAL CHARACTERISTICS(Cont.)

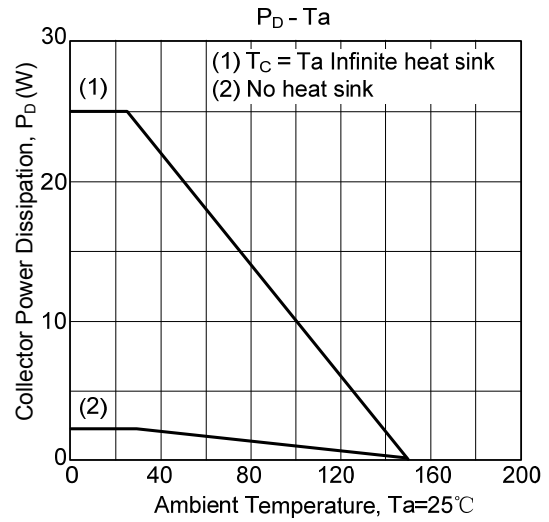
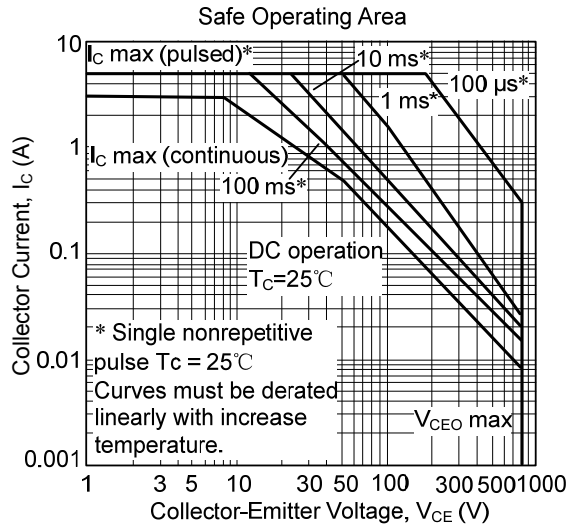

UTC assumes no responsibility for equipment failures that result from using products at values that exceed, even momentarily, rated values (such as maximum ratings, operating condition ranges, or other parameters) listed in products specifications of any and all UTC products described or contained herein. UTC products are not designed for use in life support appliances, devices or systems where malfunction of these products can be reasonably expected to result in personal injury. Reproduction in whole or in part is prohibited without the prior written consent of the copyright owner. The information presented in this document does not form part of any quotation or contract, is believed to be accurate and reliable and may be changed without notice.