

4

3

2

1

THIS DRAWING IS UNPUBLISHED.

RELEASED FOR PUBLICATION

© COPYRIGHT - BY TYCO ELECTRONICS CORPORATION. ALL RIGHTS RESERVED.

LOC
HDIST
-

REVISIONS

P	LTR	DESCRIPTION	DATE	DWN	APVD
	A	RELEASED FOR PRODUCTION	24OCT2016	RK	MvE
	A1	CHANGED LASER MARKING	03NOV2016	RK	MvE

DIMENSIONS BEFORE APPLICATION

NOTES:

- 2213600-1 AS SHOWN.
- MATERIALS:

CONTACT: PHOSPHOR BRONZE, TIN PLATED
 HOUSING: PC NOT GLASS FILLED
 BUTTONS: PC NOT GLASS FILLED

3 LASER MARKING:
 • (KEMA) PENDING
 • (UL) PENDING
 • TE LOGO
 • TE PART NUMBER
 • DATE CODE

4 LASER MARKING: IP20

5 LASER MARKING: IP x5/x7

UNSEALED	4	A=4.0 B=3.5	14/16 TO 16/18	BLUE AND RED	CLEAR	2213600-6
UNSEALED	4	A=4.5 B=3.5	12/14 TO 16/18	YELLOW AND RED	CLEAR	2213600-5
UNSEALED	4	A=4.5 B=4.0	12/14 TO 14/16	YELLOW AND BLUE	CLEAR	2213600-4
SEALED	5	A=4.0 B=3.5	14/16 TO 16/18	BLUE AND RED	CLEAR	2213600-3
SEALED	5	A=4.5 B=3.5	12/14 TO 16/18	YELLOW AND RED	CLEAR	2213600-2
SEALED	5	A=4.5 B=4.0	12/14 TO 14/16	YELLOW AND BLUE	CLEAR	2213600-1
SEALING		WIRE ENTRY	WIRE SIZE	BUTTON COLORS	HOUSING COLOR	PART NUMBER

THIS DRAWING IS A CONTROLLED DOCUMENT.
 DIMENSIONING AND TOLERANCING PER ASME Y14.5M-2009.

DIMENSIONS:	TOLERANCES UNLESS OTHERWISE SPECIFIED:
mm	
	0 PLC ±0,2
	1 PLC ±0,2
	2 PLC ±0,2
	3 PLC ±
	4 PLC ±
	ANGLES ±
MATERIAL	FINISH

DWN	M.V.ESSSEN	06 NOV'15
CHK	C.V.STEENDEREN	-
APVD	O.I.FIJNSE	-
PRODUCT SPEC	108-133061	
APPLICATION SPEC	114-133061	
WEIGHT	-	
CUSTOMER DRAWING		

COOL SPLICE
 ONE POSITION LARGE WIRE GAUGE

SIZE	CAGE CODE	DRAWING NO	RESTRICTED TO
A3	00779	©-2213600	-

SCALE 2:1 SHEET 1 OF 3 REV A1

1470-19 (3/11)

THIS DRAWING IS UNPUBLISHED.

RELEASED FOR PUBLICATION

© COPYRIGHT - BY TYCO ELECTRONICS CORPORATION. ALL RIGHTS RESERVED.

LOC	DIST	REVISIONS					
		P	LTR	DESCRIPTION	DATE	DWN	APVD
		-		SEE SHEET 1	-	-	-

DIMENSIONS AFTER APPLICATION

NOTE:
1. 2213600-1 AS SHOWN.

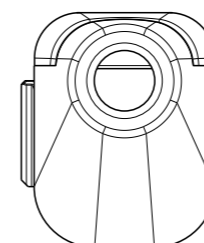
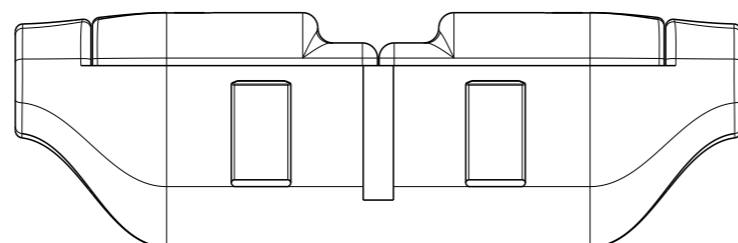
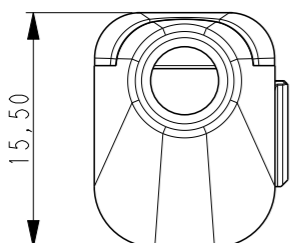
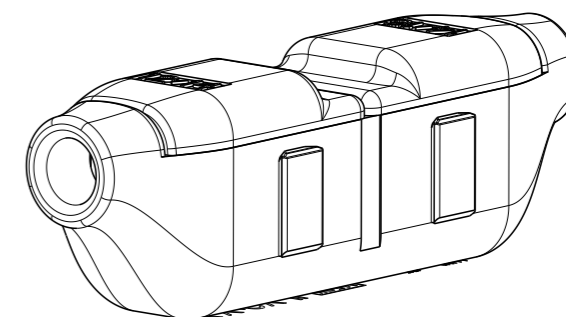
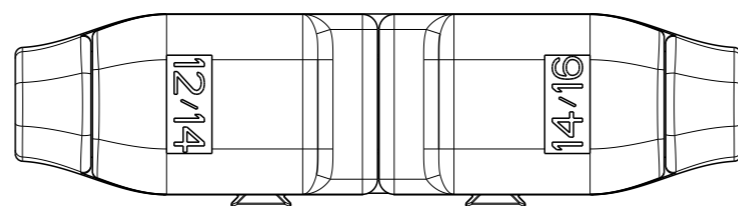

THIS DRAWING IS A CONTROLLED DOCUMENT.		DWN M.V.ESSSEN	06 NOV '15	 TE Connectivity	
DIMENSIONS: mm		CHK C.V.STEENDEREN	-		
TOLERANCES UNLESS OTHERWISE SPECIFIED:		APVD O.IEIJNSE	-	NAME COOL SPLICE ONE POSITION LARGE WIRE GAUGE	
0 PLC ±- 1 PLC ±0,2 2 PLC ±0,2 3 PLC ±- 4 PLC ±- ANGLES ±-		PRODUCT SPEC 108-133061		RESTRICTED TO	
MATERIAL		APPLICATION SPEC 114-133061		SIZE A3	CAGE CODE 00779
FINISH		WEIGHT	-	DRAWING NO C-2213600	
		CUSTOMER DRAWING		SCALE 1:1	SHEET 2 OF 3
				REV A1	

THIS DRAWING IS UNPUBLISHED.

RELEASED FOR PUBLICATION

© COPYRIGHT - BY TYCO ELECTRONICS CORPORATION. ALL RIGHTS RESERVED.

LOC	DIST	REVISIONS					
		P	LTR	DESCRIPTION	DATE	DWN	APVD
		-		SEE SHEET 1	-	-	-

DIMENSIONS AFTER STACKING

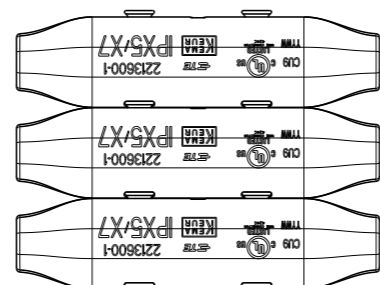
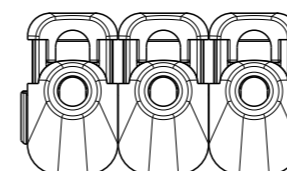
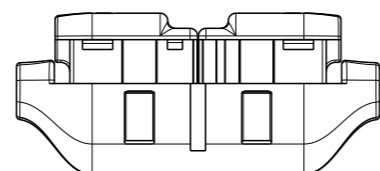
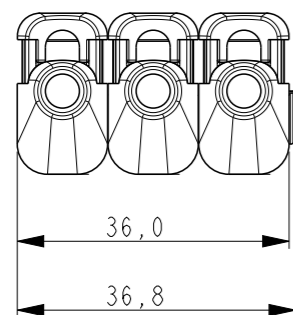
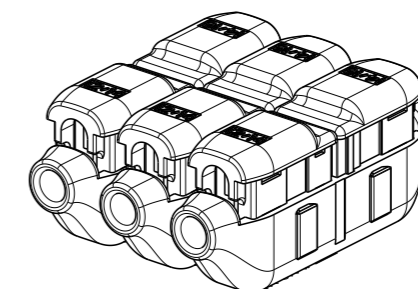
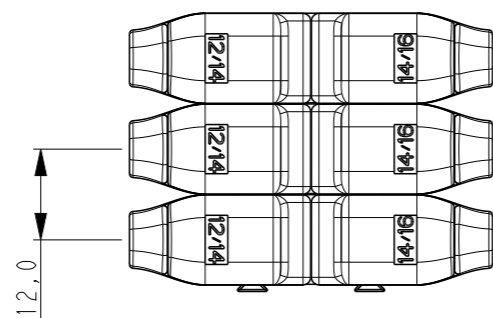

THIS DRAWING IS A CONTROLLED DOCUMENT.		DWN M.V.ESSEN 06 NOV '15	 TE Connectivity		
DIMENSIONS: mm		CHK C.V.STEENDEREN			
TOLERANCES UNLESS OTHERWISE SPECIFIED:		APVD O.IEIJNSE	NAME COOL SPLICE ONE POSITION LARGE WIRE GAUGE		
<ul style="list-style-type: none"> 0 PLC ±- 1 PLC ±0,2 2 PLC ±0,2 3 PLC ±- 4 PLC ±- ANGLES ±- 		PRODUCT SPEC 108-133061	RESTRICTED TO		
MATERIAL		APPLICATION SPEC 114-133061	SIZE A3	CAGE CODE 00779	DRAWING NO C-2213600
FINISH		WEIGHT	SCALE 1:1		
		CUSTOMER DRAWING	SHEET 3 OF 3		
			REV A1		