

RICOH

R1160x SERIES

3-MODE 200mA LDO REGULATOR

NO.EA-083-140530

OUTLINE

The R1160x Series consist of CMOS-based voltage regulator ICs with high output voltage accuracy, low supply current, and low ON-resistance. Each of these voltage regulator ICs consists of a voltage reference unit, an error amplifier, resistors for setting Output Voltage, a current limit circuit, and a chip enable circuit.

These ICs perform with low dropout voltage and a chip enable function. To prevent the destruction by over current, current limit circuit is included. The R1160x Series have 3-mode. One is standby mode with CE or standby control pin. Other two modes are realized with ECO pin™. Fast Transient Mode (FT mode) and Low Power Mode (LP mode) are alternative with ECO pin™. Consumption current is reduced to 1/10 at Low Power Mode compared with Fast Transient Mode. Output voltage is maintained between FT mode and LP mode.

The output voltage of these ICs is internally fixed with high accuracy. Since the packages for these ICs are SOT-23-5 and SON-6 packages, high density mounting of the ICs on boards is possible.

FEATURES

- Supply Current (Low Power Mode)..... Typ. 3.5 μ A ($V_{OUT} \leq 1.5V$)
- Supply Current (Fast Transient Mode)..... Typ. 40 μ A
- Supply Current (Standby Mode)..... Typ. 0.1 μ A
- Dropout Voltage Typ. 0.14V ($I_{OUT}=200mA$, $V_{OUT}=2.8V$)
- Ripple Rejection..... Typ. 70dB ($f=1kHz$, FT Mode)
- Temperature-Drift Coefficient of Output Voltage Typ. $\pm 100ppm/^{\circ}C$
- Line Regulation Typ. 0.05%/V
- Output Voltage Accuracy..... $\pm 2.0%$ ($\pm 3.0%$ at LP Mode)
- Output Voltage Range..... 0.8V to 3.3V (0.1V steps)
(For other voltages, please refer to MARK INFORMATION.)
- Input Voltage Range 1.4V to 6.0V
- Built-in Fold Back Protection Circuit Typ. 50mA (Current at short mode)
- Packages SOT-23-5, SON-6

APPLICATIONS

- Precision Voltage References.
- Power source for electrical appliances such as cameras, VCRs and hand-held communication equipment.
- Power source for battery-powered equipment.

* R1160D (SON-6) is the discontinued product. As of March in 2015.

R1160x

BLOCK DIAGRAMS

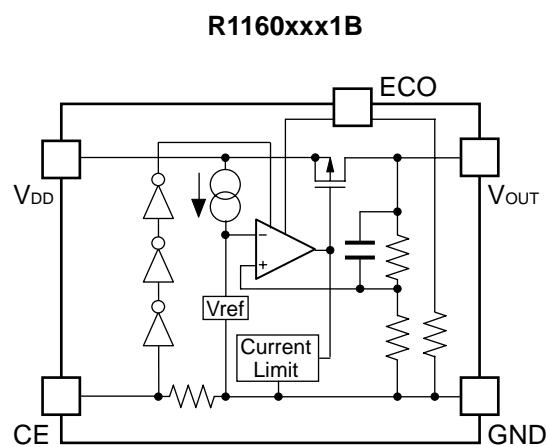
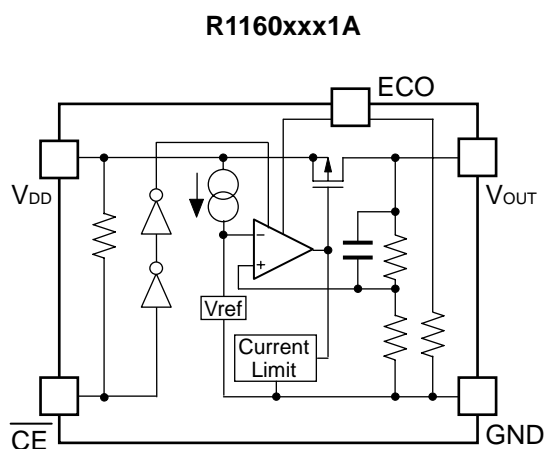

SELECTION GUIDE

The output voltage, chip enable polarity, and package, etc. for the ICs can be selected at the user's request.

Product Name	Package	Quantity per Reel	Pb Free	Halogen Free
R1160Nxx1*-TR-FE	SOT-23-5	3,000 pcs	Yes	Yes
R1160Dxx1*-TR-FE	SON-6	3,000 pcs	Yes	Yes

xx: The output voltage can be designated in the range from 0.8V(08) to 3.3V(33) in 0.1V steps.
(For other voltages, please refer to MARK INFORMATION.)

* : CE pin polarity are options as follows.
(A) "L" active type.
(B) "H" active type.

PIN CONFIGURATION

• SOT-23-5

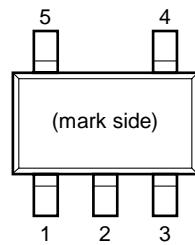

• SON-6

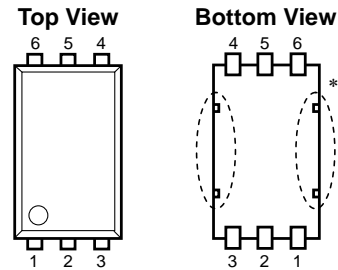

PIN DESCRIPTIONS

• SOT-23-5

Pin No	Symbol	Pin Description
1	V_{DD}	Input Pin
2	GND	Ground Pin
3	\overline{CE} or CE	Chip Enable Pin
4	ECO	MODE alternative pin
5	V_{OUT}	Output Pin

• SON-6

Pin No	Symbol	Pin Description
1	V_{DD}	Input Pin
2	NC	No Connection
3	V_{OUT}	Output Pin
4	ECO	MODE alternative pin
5	GND	Ground Pin
6	\overline{CE} or CE	Chip Enable Pin

*) Tab suspension leads are GND level. (They are connected to the reverse side of this IC.)
The tab suspension leads should be open and do not connect to other wires or land patterns.

R1160x

ABSOLUTE MAXIMUM RATINGS

Symbol	Item	Rating	Unit
V_{IN}	Input Voltage	6.5	V
V_{ECO}	Input Voltage (ECO Pin)	-0.3 to $V_{IN}+0.3$	V
V_{CE}	Input Voltage (\overline{CE} or CE Pin)	-0.3 to $V_{IN}+0.3$	V
V_{OUT}	Output Voltage	-0.3 to $V_{IN}+0.3$	V
I_{OUT}	Output Current	250	mA
P_D	Power Dissipation (SOT-23-5)*	420	mW
	Power Dissipation (SON-6)*	500	mW
T_{opt}	Operating Temperature Range	-40 to 85	°C
T_{stg}	Storage Temperature Range	-55 to 125	°C

*) For Power Dissipation, please refer to PACKAGE INFORMATION.

ABSOLUTE MAXIMUM RATINGS

Electronic and mechanical stress momentarily exceeded absolute maximum ratings may cause the permanent damages and may degrade the life time and safety for both device and system using the device in the field.

The functional operation at or over these absolute maximum ratings is not assured.

RECOMMENDED OPERATING CONDITIONS (ELECTRICAL CHARACTERISTICS)

All of electronic equipment should be designed that the mounted semiconductor devices operate within the recommended operating conditions. The semiconductor devices cannot operate normally over the recommended operating conditions, even if when they are used over such conditions by momentary electronic noise or surge. And the semiconductor devices may receive serious damage when they continue to operate over the recommended operating conditions.

ELECTRICAL CHARACTERISTICS

• R1160xxx1A

T_{opt}=25°C

Symbol	Item	Conditions	Min.	Typ.	Max.	Unit
V _{OUT}	Output Voltage (FT Mode)	V _{IN} =Set V _{OUT} +1V, V _{ECO} =V _{IN} 1μA ≤ I _{OUT} ≤ 30mA *1	×0.98 (-30mV)		×1.02 (30mV)	V
	Output Voltage (LP Mode)	V _{IN} =Set V _{OUT} +1V, V _{ECO} =GND 1μA ≤ I _{OUT} ≤ 30mA *2	×0.97 (-45mV)		×1.03 (45mV)	V
I _{OUT}	Output Current	V _{IN} -V _{OUT} =1V	200			mA
ΔV _{OUT} /ΔI _{OUT}	Load Regulation (FT Mode)	V _{IN} =Set V _{OUT} +1V, V _{ECO} =V _{IN} 1mA ≤ I _{OUT} ≤ 200mA		20	40	mV
	Load Regulation (LP Mode)	V _{IN} =Set V _{OUT} +1V, V _{ECO} =GND 1mA ≤ I _{OUT} ≤ 100mA		10	40	mV
V _{DIF}	Dropout Voltage	Refer to the ELECTRICAL CHARACTERISTICS by OUTPUT VOLTAGE				
I _{SS1}	Supply Current (FT Mode)	V _{IN} =Set V _{OUT} +1V, V _{ECO} =V _{IN} ,		40	70	μA
I _{SS2}	Supply Current (LP Mode)	V _{IN} =Set V _{OUT} +1V, V _{OUT} ≤ 1.5V, V _{ECO} =GND		3.5	6.0	μA
		V _{IN} =Set V _{OUT} +1V, V _{OUT} ≥ 1.6V, V _{ECO} =GND		4.5	8.0	μA
I _{standby}	Supply Current (Standby)	V _{IN} =V _{CE} =Set V _{OUT} +1V V _{ECO} =GND or V _{IN}		0.1	1.0	μA
ΔV _{OUT} /ΔV _{IN}	Line Regulation (FT Mode)	Set V _{OUT} +0.5V ≤ V _{IN} ≤ 6V I _{OUT} =30mA, V _{ECO} =V _{IN} (In case that V _{OUT} ≤ 0.9V, 1.4V ≤ V _{IN} ≤ 6V)		0.05	0.20	%/V
	Line Regulation (LP Mode)	Set V _{OUT} +0.5V ≤ V _{IN} ≤ 6V I _{OUT} =30mA, V _{ECO} =GND (In case that V _{OUT} ≤ 0.9V, 1.4V ≤ V _{IN} ≤ 6V)		0.10	0.30	%/V
RR	Ripple Rejection (FT Mode)	f=1kHz, Ripple 0.2Vp-p V _{IN} =Set V _{OUT} +1V I _{OUT} =30mA, V _{ECO} =V _{IN}		70		dB
V _{IN}	Input Voltage		1.4		6.0	V
ΔV _{OUT} /ΔT _{opt}	Output Voltage Temperature Coefficient	I _{OUT} =30mA -40°C ≤ T _{opt} ≤ 85°C		±100		ppm/°C
I _{SC}	Short Current Limit	V _{OUT} =0V		50		mA
R _{PUC}	\overline{CE} Pull-up Resistance		2.0	5.0	14.0	MΩ
R _{PDE}	ECO Pull-down Resistance		1.5	5.0	14.0	MΩ
V _{CEH}	\overline{CE} , ECO Input Voltage "H"		1.0		V _{IN}	V
V _{CEL}	\overline{CE} , ECO Input Voltage "L"		0		0.3	V

*1 : ±30mV Tolerance for V_{OUT} ≤ 1.5V*2 : ±45mV Tolerance for V_{OUT} ≤ 1.5V

* R1160D (SON-6) is the discontinued product. As of March in 2015.

R1160x

• R1160xxx1B

T_{opt}=25°C

Symbol	Item	Conditions	Min.	Typ.	Max.	Unit
V _{OUT}	Output Voltage (FT Mode)	V _{IN} =Set V _{OUT} +1V, V _{ECO} =V _{IN} 1μA ≤ I _{OUT} ≤ 30mA *1	×0.980 (-30mV)		×1.020 (30mV)	V
	Output Voltage (LP Mode)	V _{IN} =Set V _{OUT} +1V, V _{ECO} =GND 1μA ≤ I _{OUT} ≤ 30mA *2	×0.970 (-45mV)		×1.030 (45mV)	V
I _{OUT}	Output Current	V _{IN} -V _{OUT} =1V	200			mA
ΔV _{OUT} /ΔI _{OUT}	Load Regulation (FT Mode)	V _{IN} =Set V _{OUT} +1V, V _{ECO} =V _{IN} 1mA ≤ I _{OUT} ≤ 200mA		20	40	mV
	Load Regulation (LP Mode)	V _{IN} =Set V _{OUT} +1V, V _{ECO} =GND 1mA ≤ I _{OUT} ≤ 100mA		10	40	mV
V _{DIF}	Dropout Voltage	Refer to the ELECTRICAL CHARACTERISTICS by OUTPUT VOLTAGE				
I _{SS1}	Supply Current (FT Mode)	V _{IN} =Set V _{OUT} +1V, V _{ECO} =V _{IN}		40	70	μA
I _{SS2}	Supply Current (LP Mode)	V _{IN} =Set V _{OUT} +1V, V _{OUT} ≤ 1.5V, V _{ECO} =GND		3.5	6.0	μA
		V _{IN} =Set V _{OUT} +1V, V _{OUT} ≥ 1.6V, V _{ECO} =GND		4.5	8.0	μA
I _{standby}	Supply Current (Standby)	V _{IN} =Set V _{OUT} +1V V _{CE} =GND, V _{ECO} =GND or V _{IN}		0.1	1.0	μA
ΔV _{OUT} /ΔV _{IN}	Line Regulation (FT Mode)	Set V _{OUT} +0.5V ≤ V _{IN} ≤ 6.0V I _{OUT} =30mA, V _{ECO} =V _{IN} (In case that V _{OUT} ≤ 0.9V, 1.4V ≤ V _{IN} ≤ 6V)		0.05	0.20	%/V
	Line Regulation (LP Mode)	Set V _{OUT} +0.5V ≤ V _{IN} ≤ 6.0V I _{OUT} =30mA, V _{ECO} =GND (In case that V _{OUT} ≤ 0.9V, 1.4V ≤ V _{IN} ≤ 6V)		0.10	0.30	%/V
RR	Ripple Rejection (FT Mode)	f=1kHz, Ripple 0.2Vp-p V _{IN} =Set V _{OUT} +1V I _{OUT} =30mA, V _{ECO} =V _{IN}		70		dB
V _{IN}	Input Voltage		1.4		6.0	V
ΔV _{OUT} /ΔT _{opt}	Output Voltage Temperature Coefficient	I _{OUT} =30mA -40°C ≤ T _{opt} ≤ 85°C		±100		ppm/°C
I _{SC}	Short Current Limit	V _{OUT} =0V		50		mA
R _{PDC}	CE Pull-down Resistance		2.0	5.0	14.0	MΩ
R _{PDE}	ECO Pull-down Resistance		1.5	5.0	14.0	MΩ
V _{CEH}	CE, ECO Input Voltage "H"		1.0		V _{IN}	V
V _{CEL}	CE, ECO Input Voltage "L"		0		0.3	V

*1 : ±30mV Tolerance for V_{OUT} ≤ 1.5V

*2 : ±45mV Tolerance for V_{OUT} ≤ 1.5V

• ELECTRICAL CHARACTERISTICS by OUTPUT VOLTAGE

T_{opt}=25°C

Output Voltage V _{OUT} (V)	Dropout Voltage V _{DIF} (V)		
	Condition	Typ.	Max.
0.8 ≤ V _{OUT} ≤ 0.9	I _{OUT} =200mA	0.40	0.70
1.0 ≤ V _{OUT} ≤ 1.4		0.30	0.50
1.5 ≤ V _{OUT} ≤ 2.5		0.20	0.30
2.6 ≤ V _{OUT}		0.14	0.20 (ECO="H") 0.25 (ECO="L")

TEST CIRCUITS

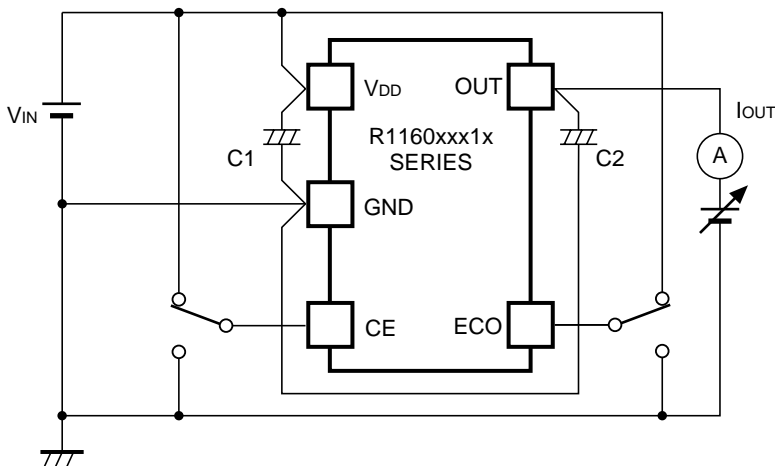

C1=Tantal 1.0μF
C2=Tantal 2.2μF

Fig.1 Output Voltage vs. Output Current Test Circuit

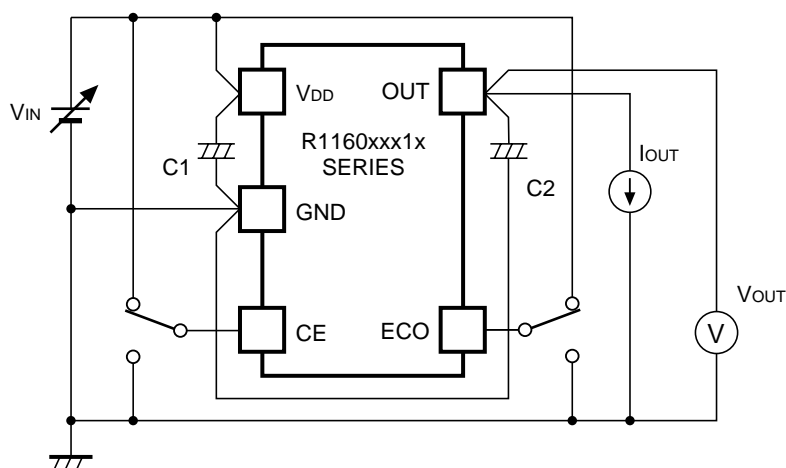

C1=Tantal 1.0μF
C2=Tantal 2.2μF

Fig.2 Output Voltage vs. Input Voltage Test Circuit

R1160x

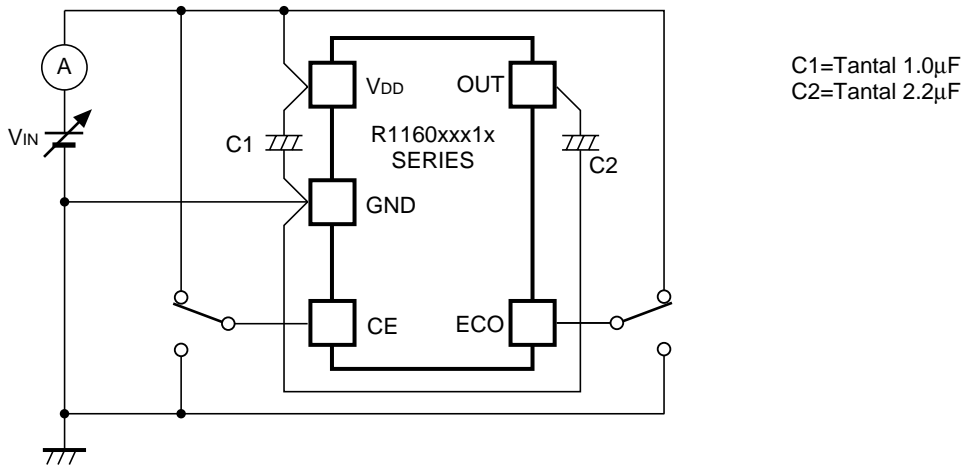

Fig.3 Supply Current vs. Input Voltage Test Circuit

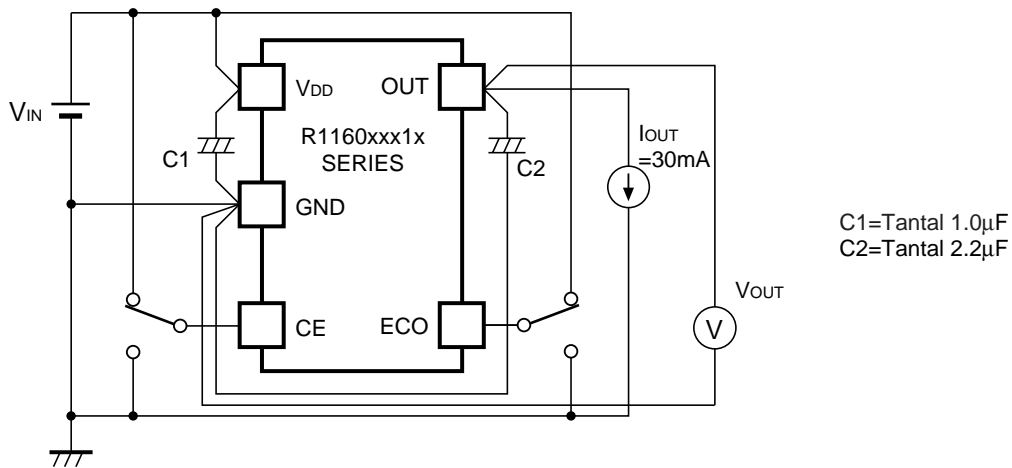

Fig.4 Output Voltage vs. Temperature Test Circuit

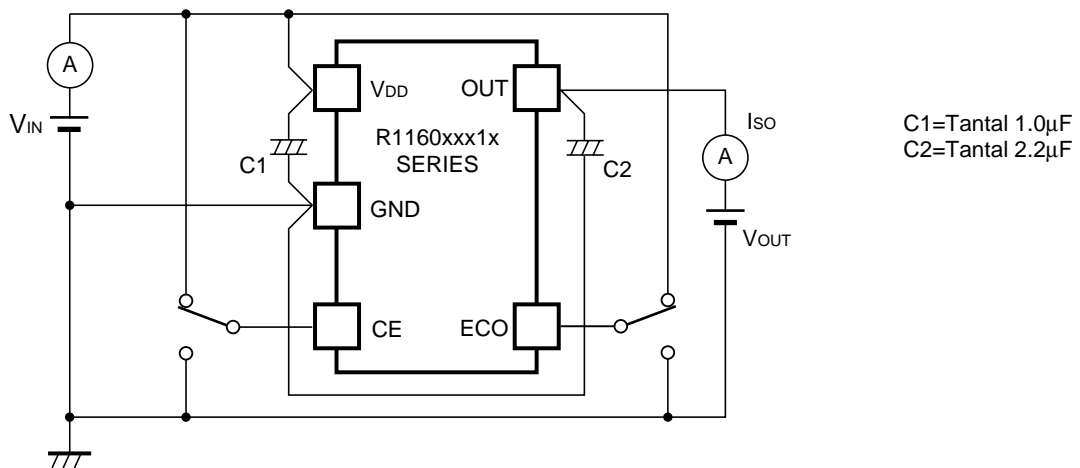

Fig.5 Supply Current vs. Temperature Test Circuit

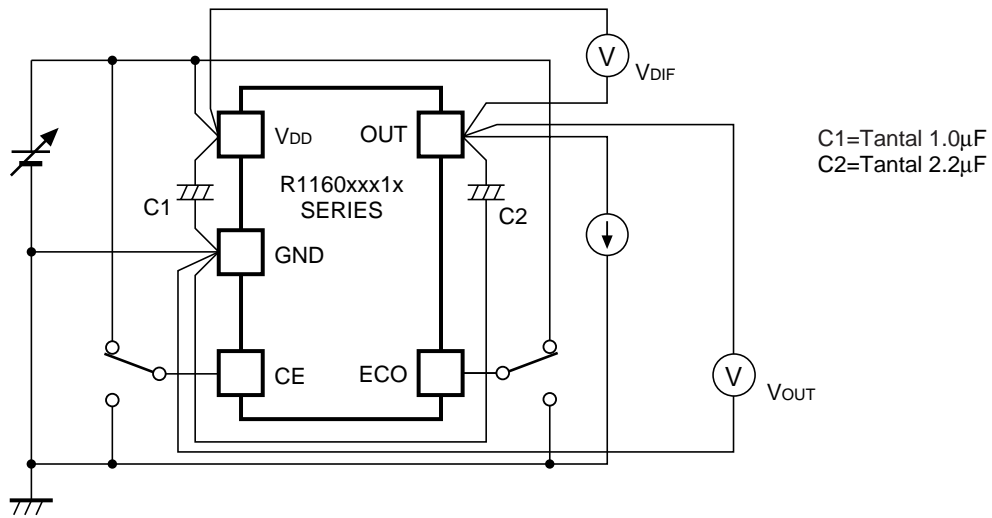

Fig. 6 Dropout Voltage vs. Output Current/ Set Output Voltage Test Circuit

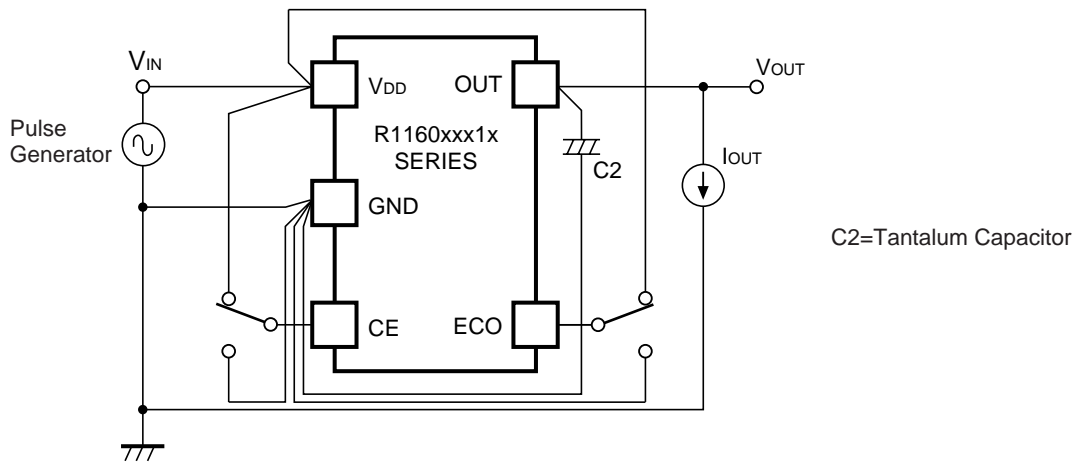

Fig. 7 Ripple Rejection Test Circuit

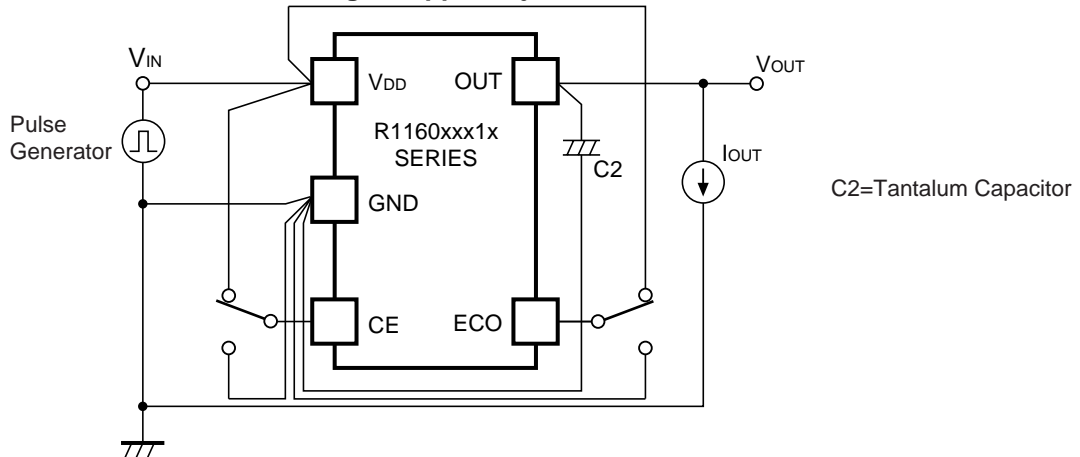

Fig.8 Input Transient Response Test Circuit

* R1160D (SON-6) is the discontinued product. As of March in 2015.

R1160x

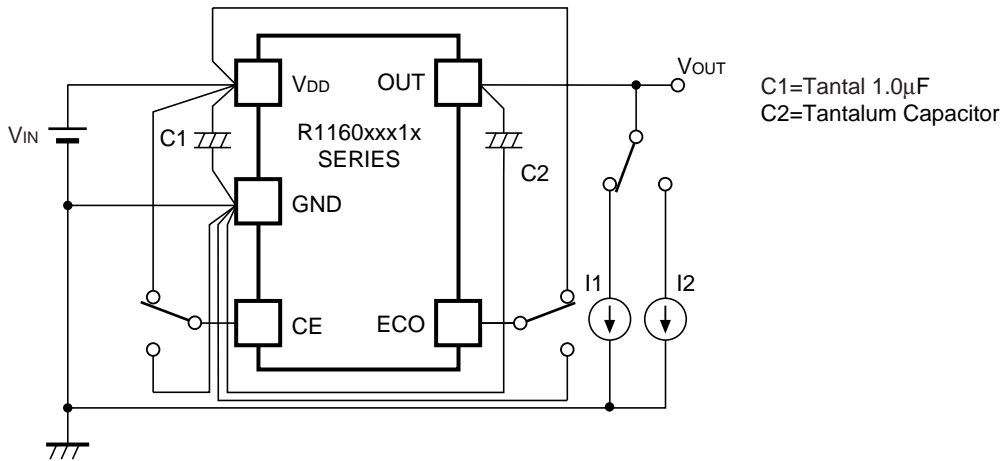

Fig.9 Load Transient Response Test Circuit

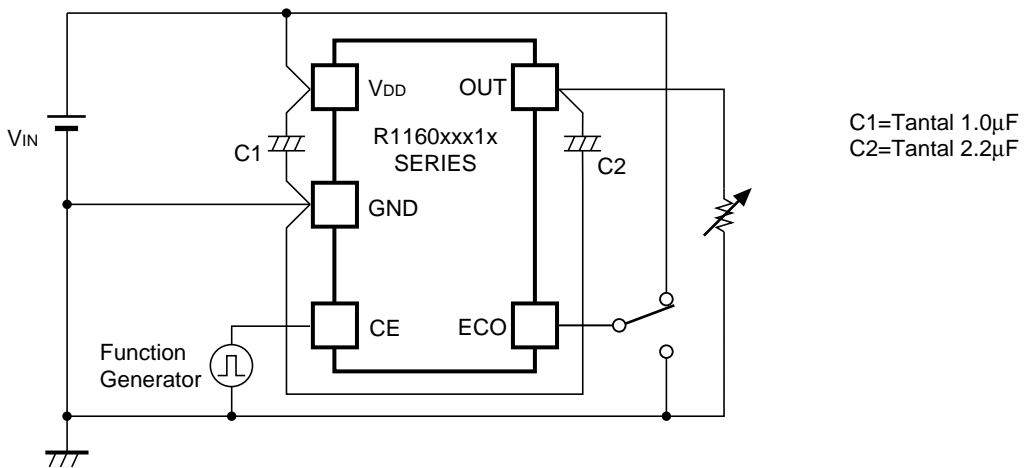

Fig.10 Turn on Speed with CE pin Test Circuit

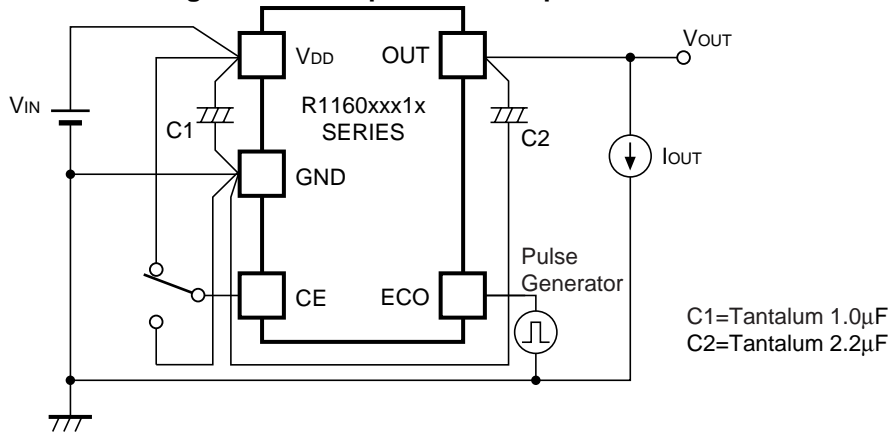

Fig.11 MODE Transient Response Test Circuit

* R1160D (SON-6) is the discontinued product. As of March in 2015.

R1160x

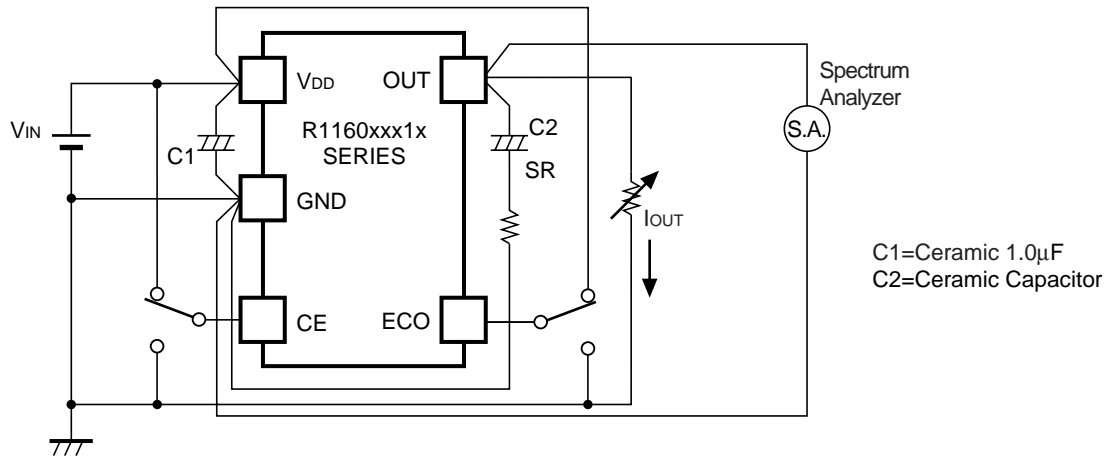
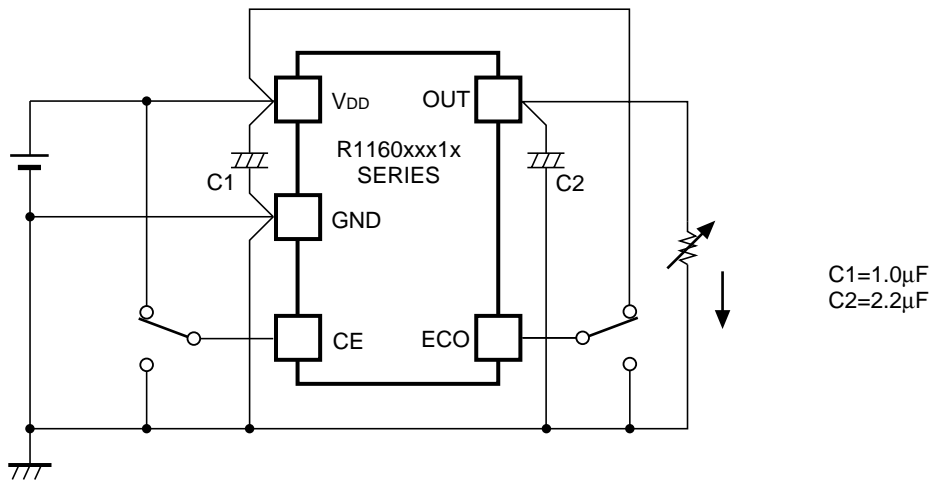

Fig.12 Output Noise Test Circuit (I_{OUT} vs. ESR)

TYPICAL APPLICATION



(External Components)

C1: Ceramic Capacitor $1\mu\text{F}$

C2: Tantalum Capacitor $2.2\mu\text{F}$

R1160x

TYPICAL CHARACTERISTICS

1) Output Voltage vs. Output Current

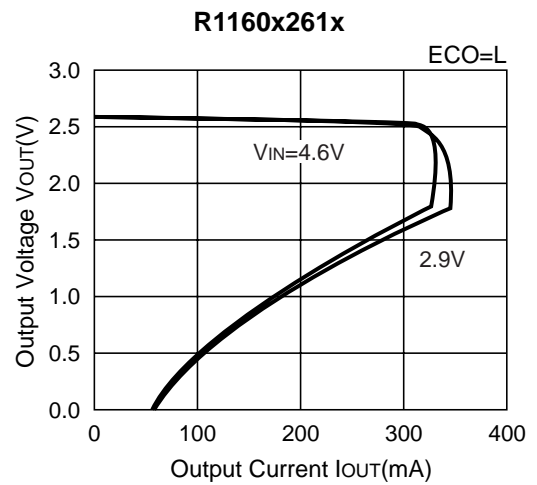
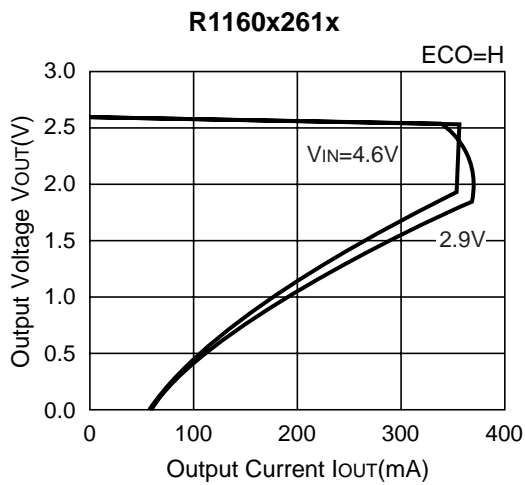
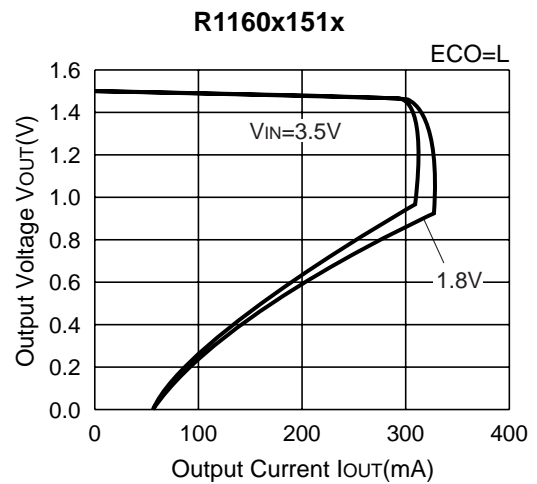
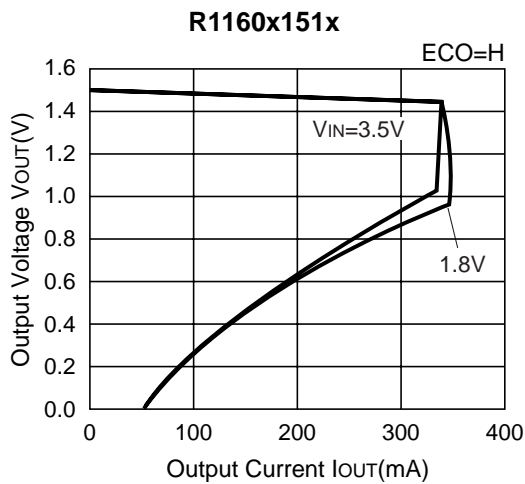
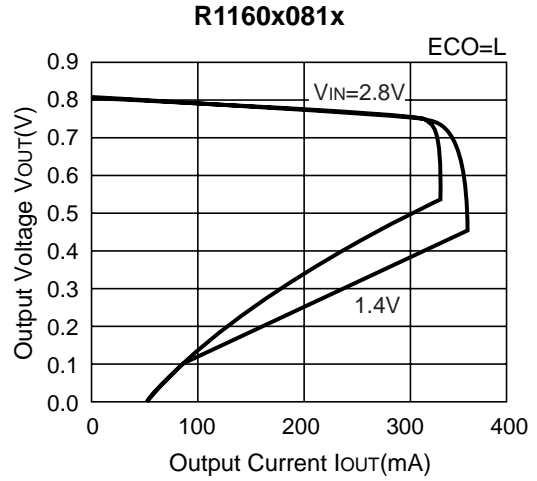
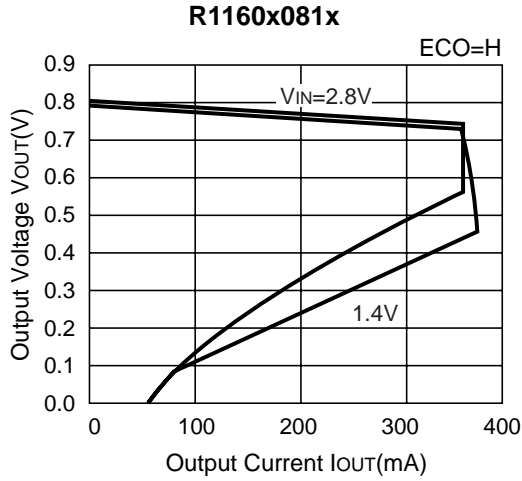

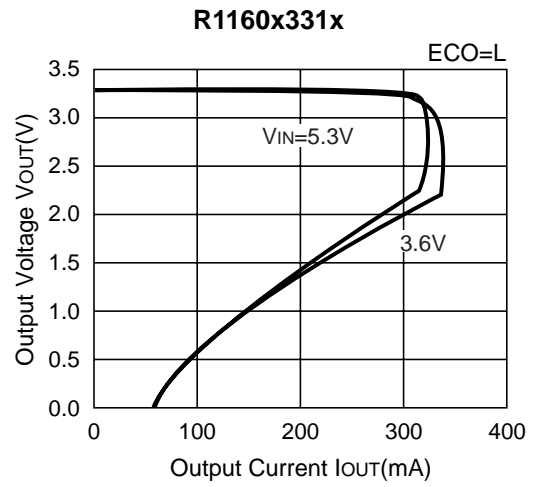
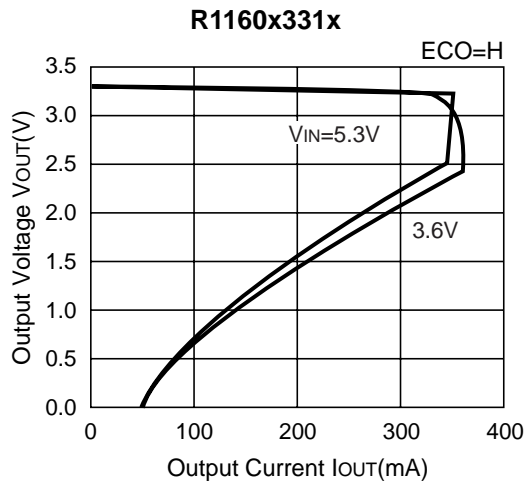

2) Output Voltage vs. Input Voltage

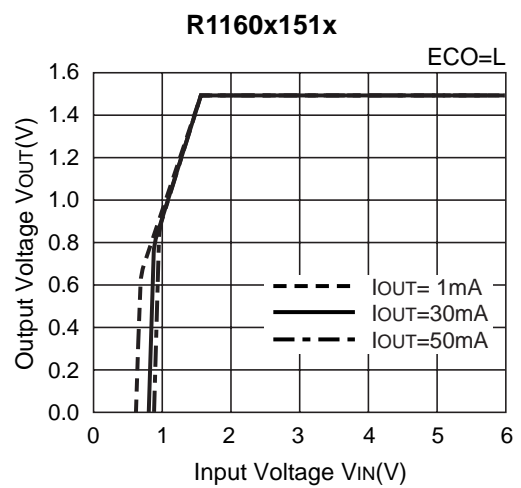
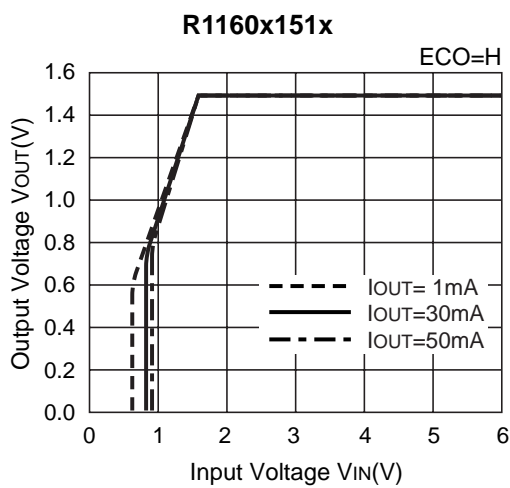
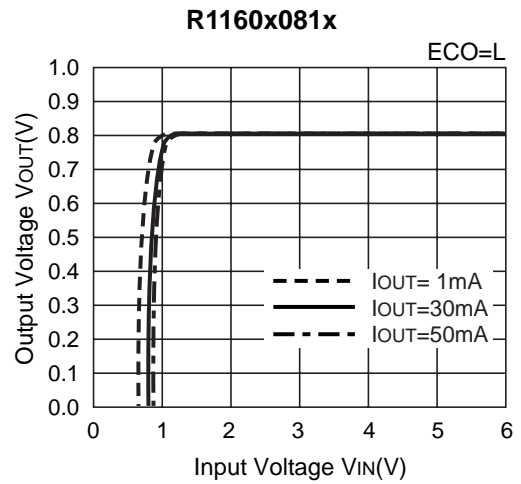
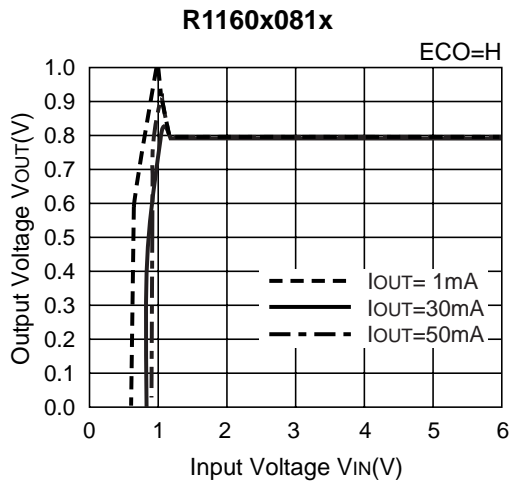

R1160x

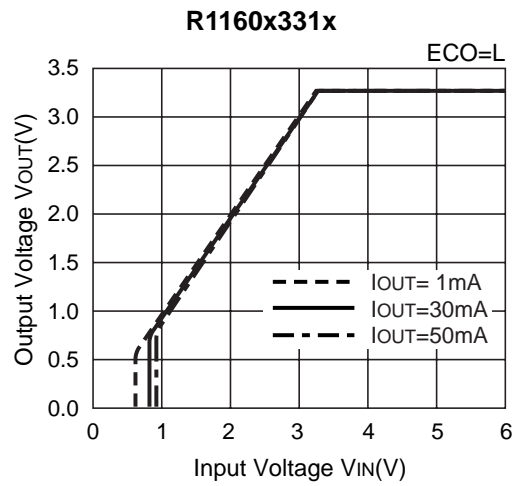
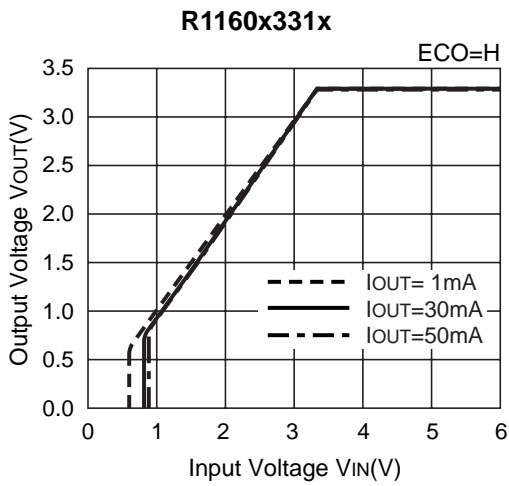
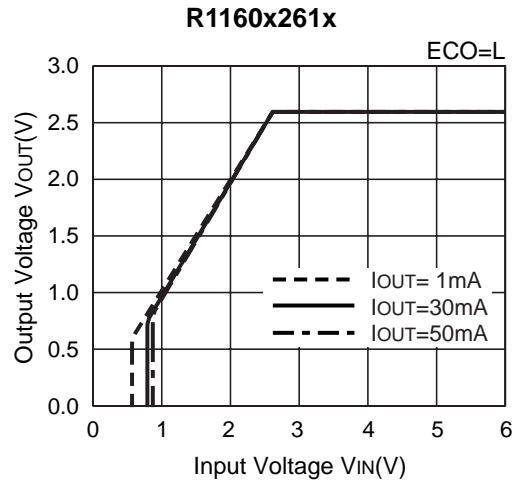
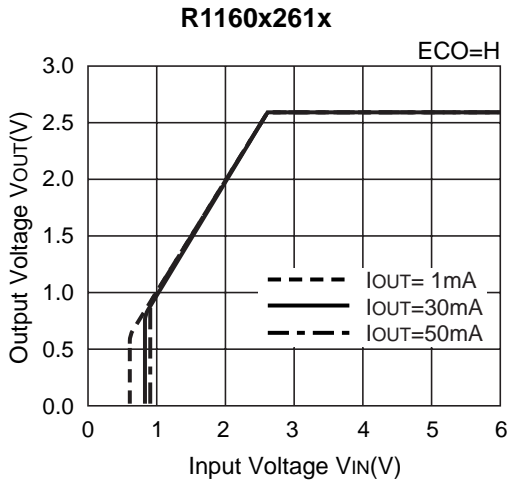

3) Supply Current vs. Input Voltage

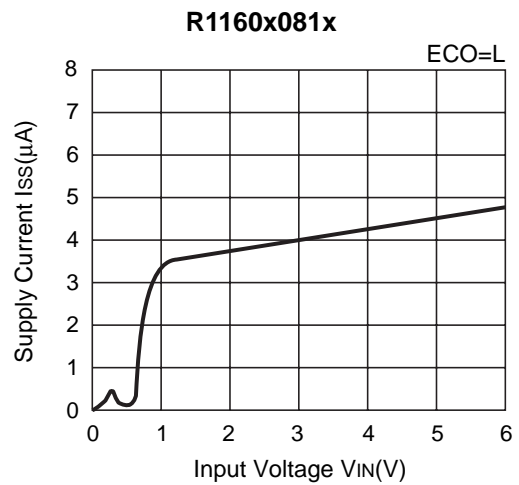
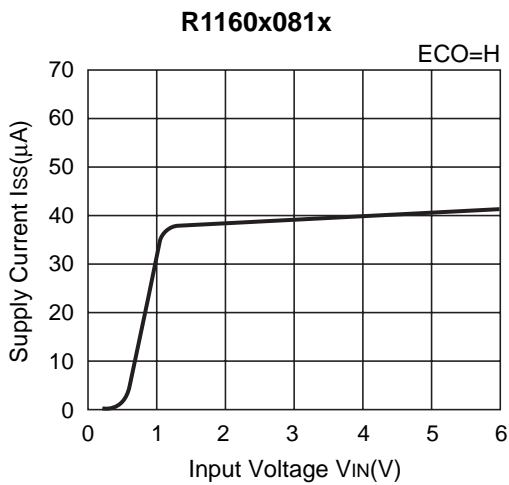

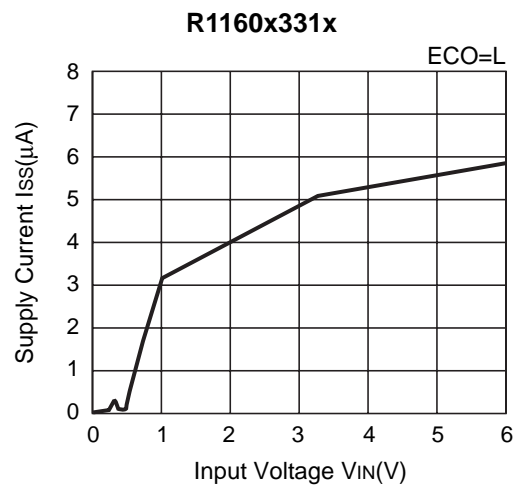
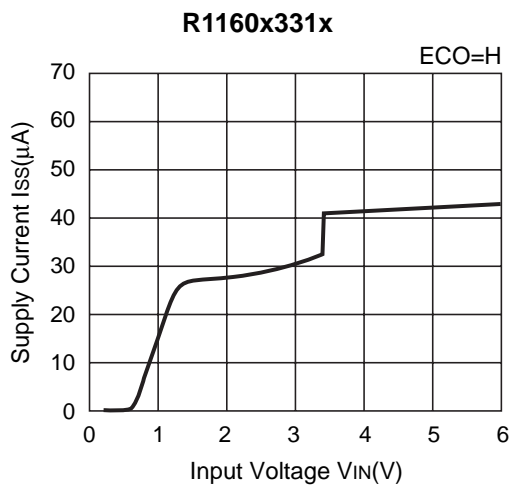
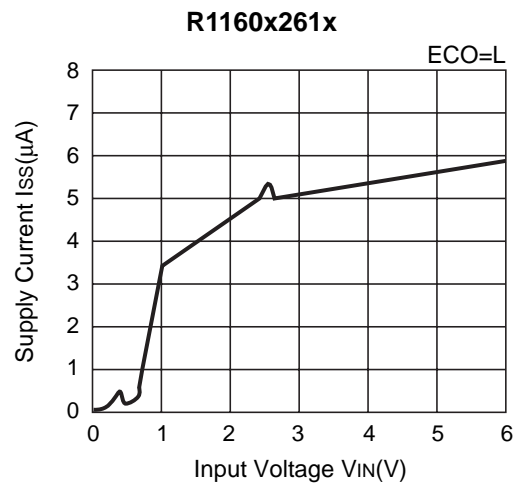
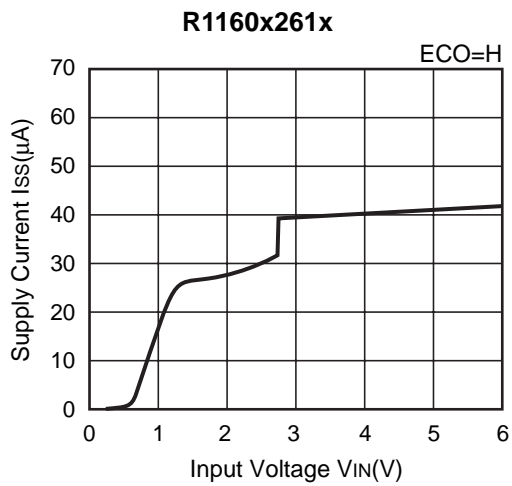
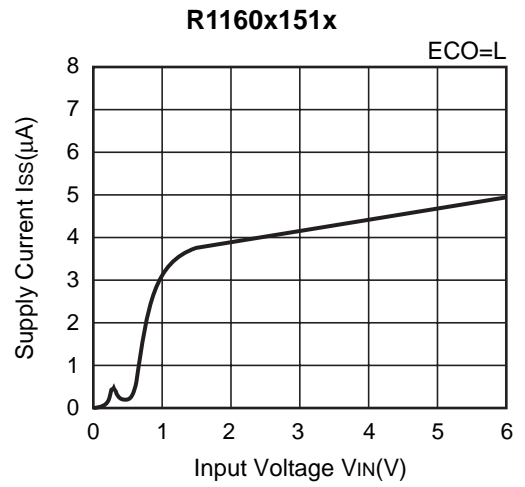
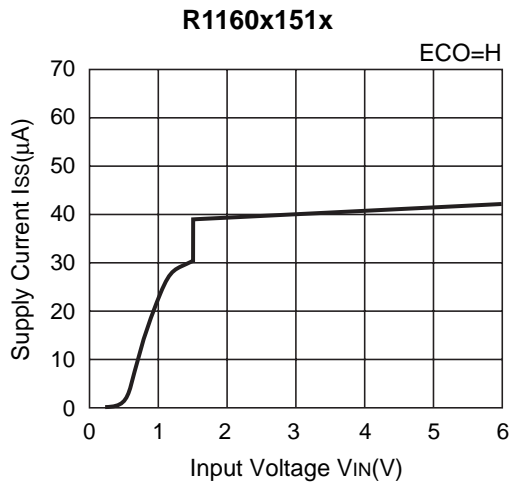

* R1160D (SON-6) is the discontinued product. As of March in 2015.

R1160x

4) Output Voltage vs. Temperature

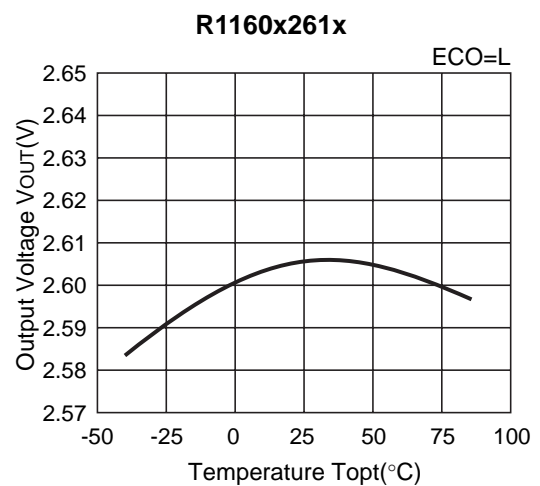
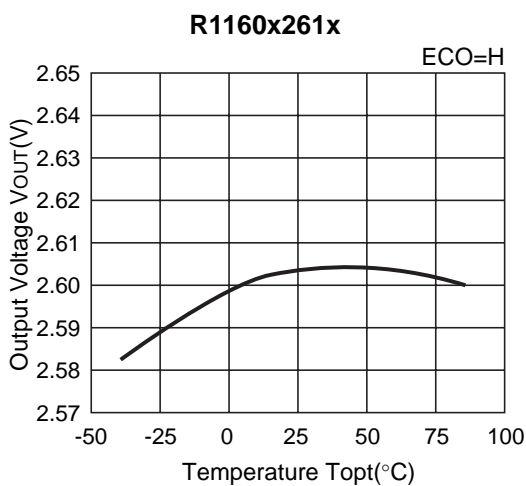
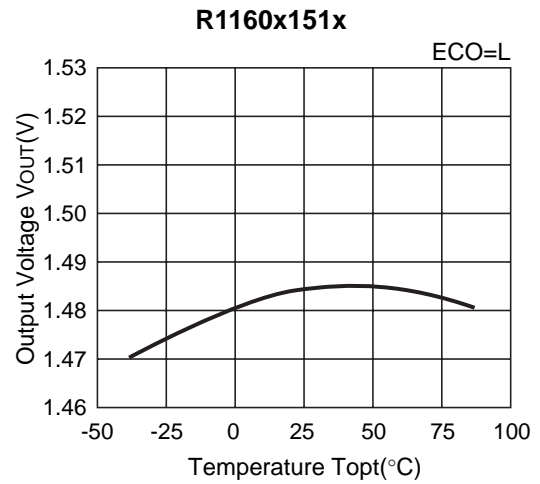
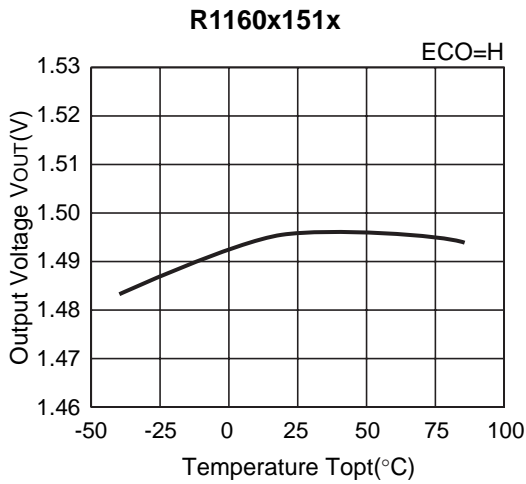
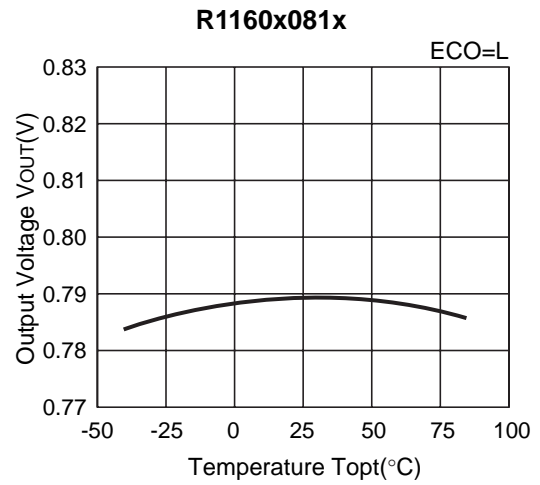
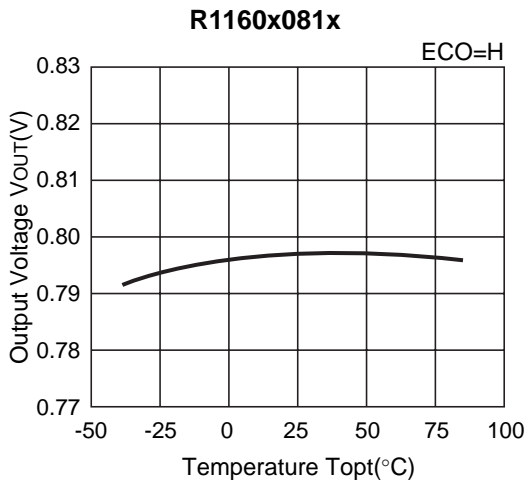

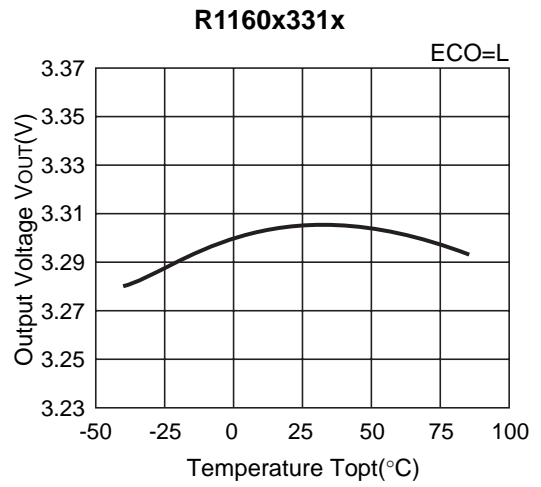
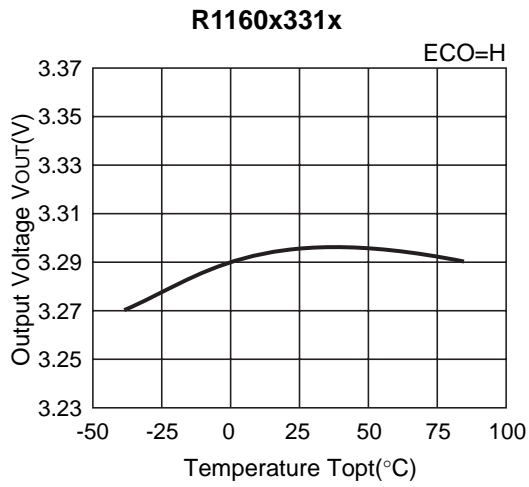

5) Supply Current vs. Input Voltage

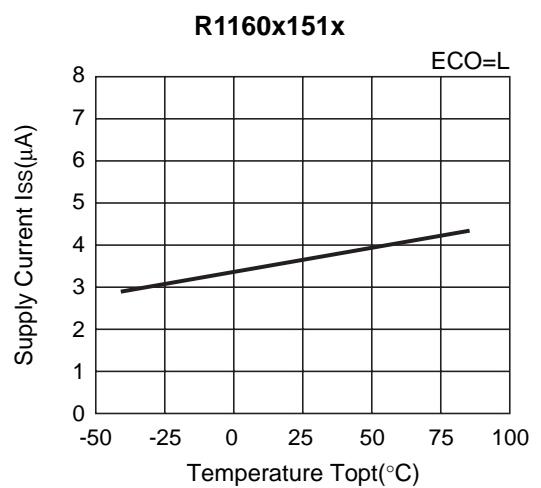
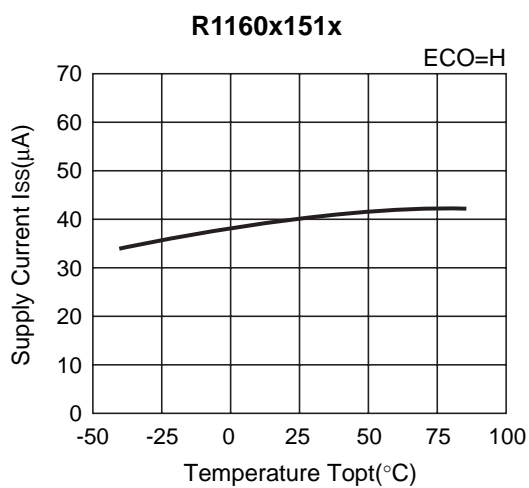
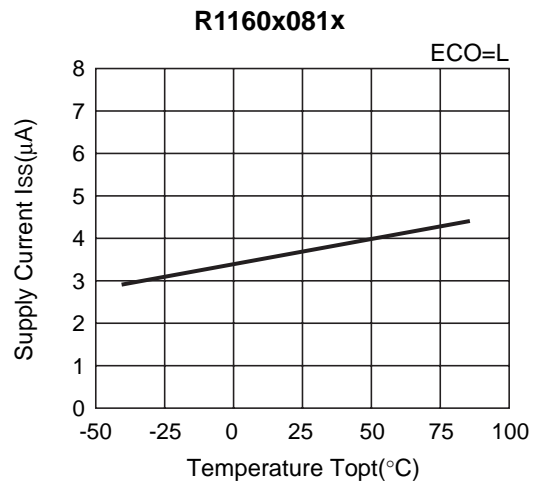
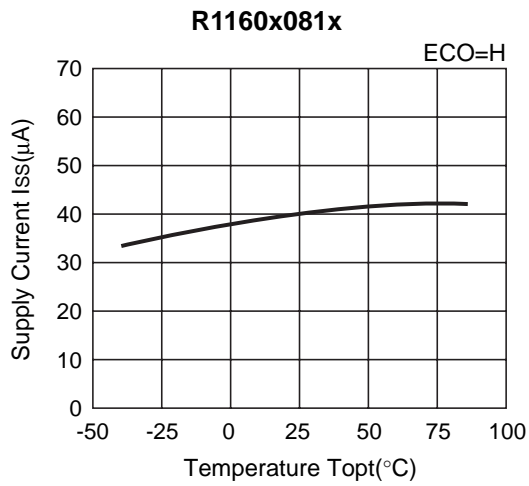

* R1160D (SON-6) is the discontinued product. As of March in 2015.

R1160x

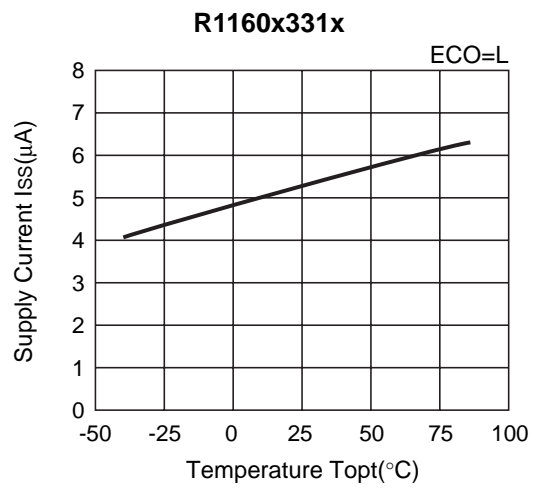
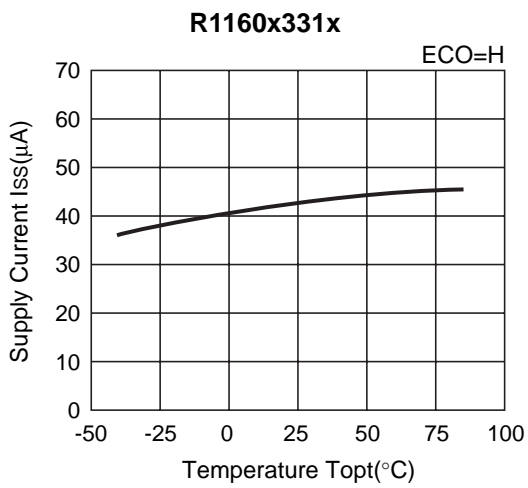
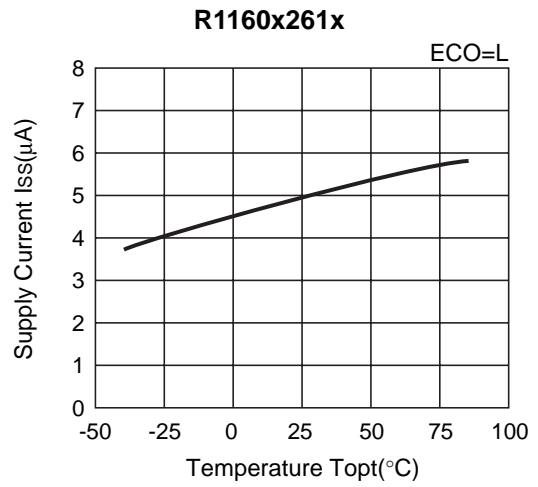
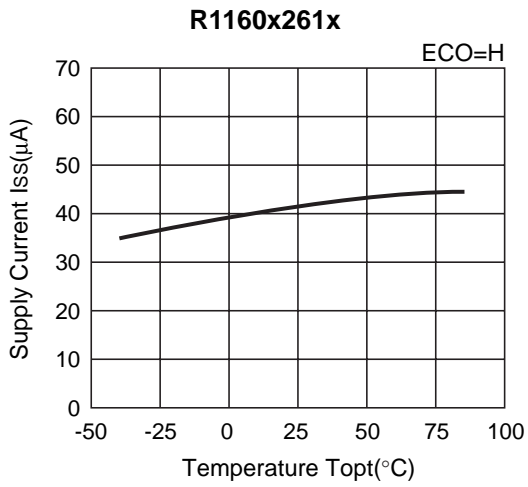

6) Dropout Voltage vs. Output Current

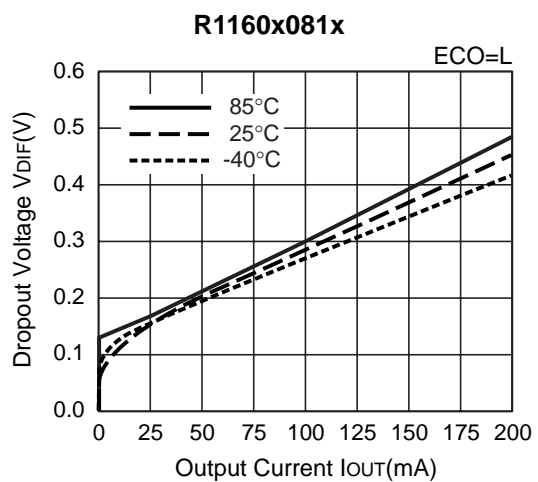
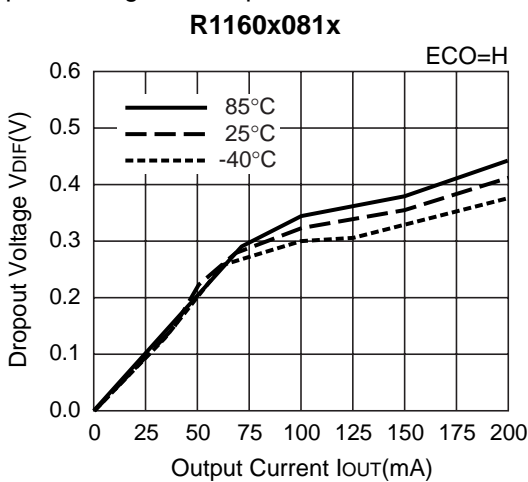

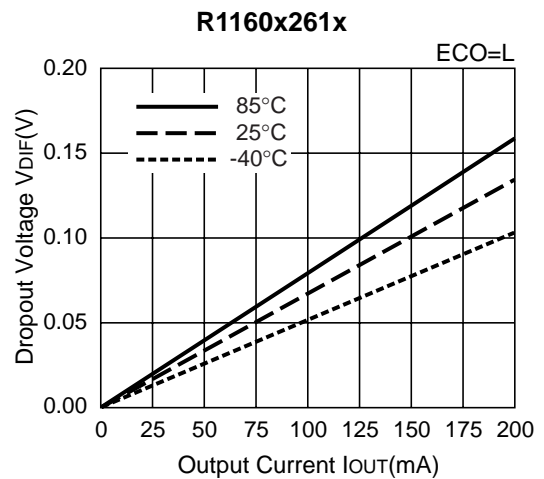
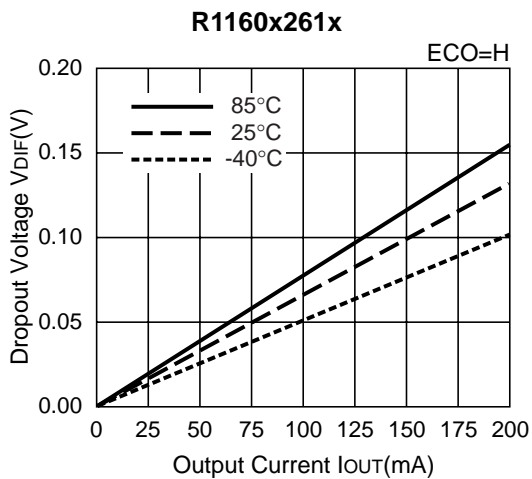
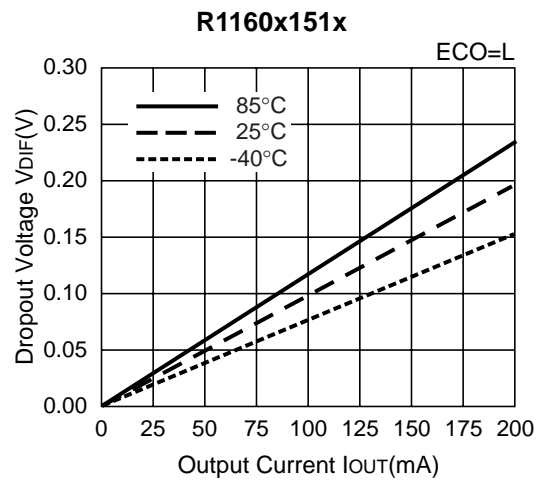
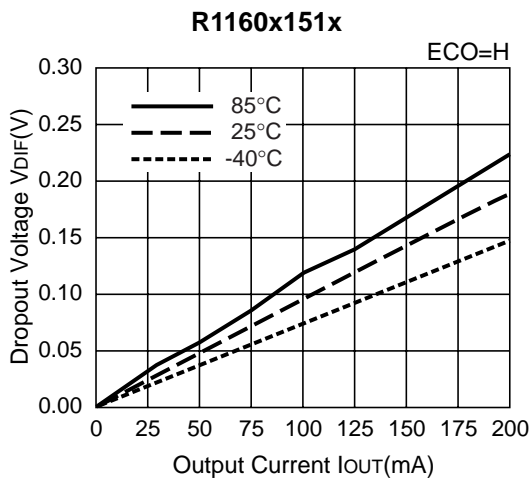
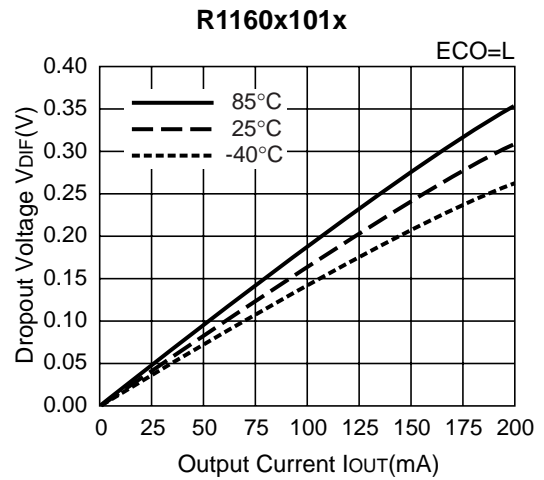
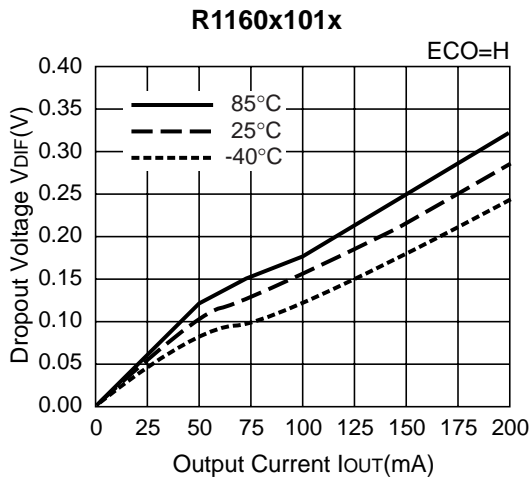

R1160x

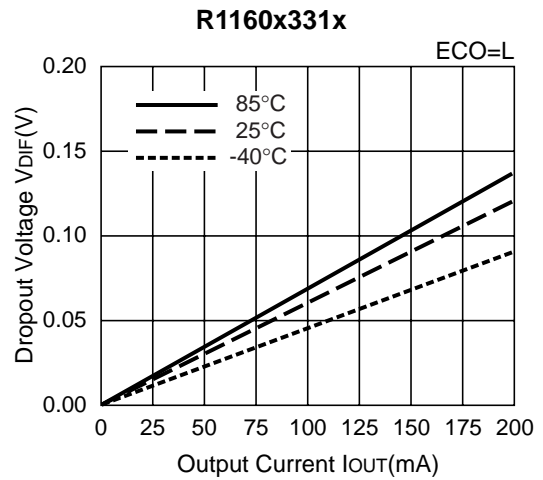
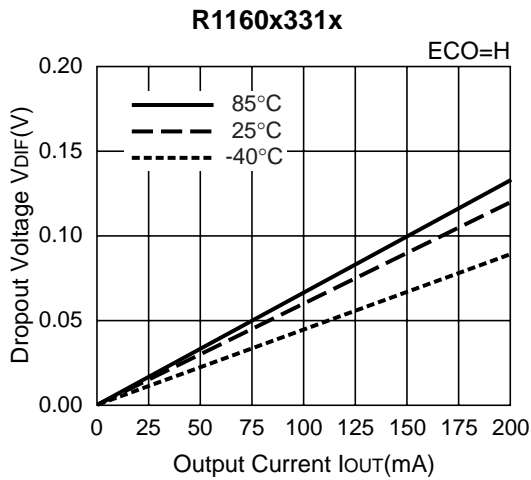

7) Dropout Voltage vs. Set Output Voltage (Topt=25°C)

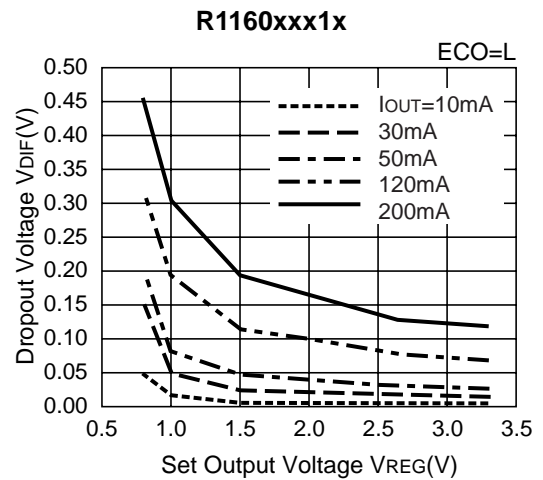
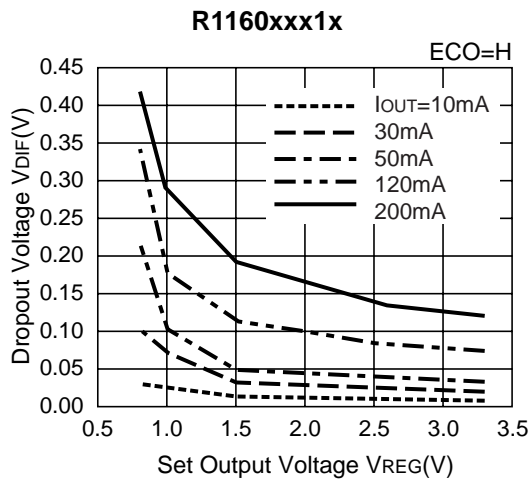

8) Ripple Rejection vs. Input Bias (Topt=25°C)

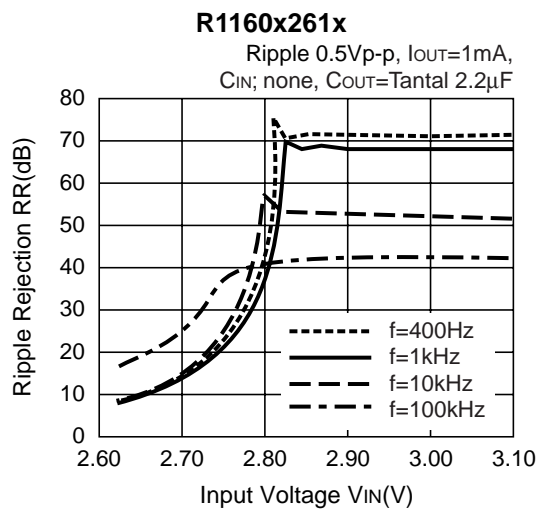
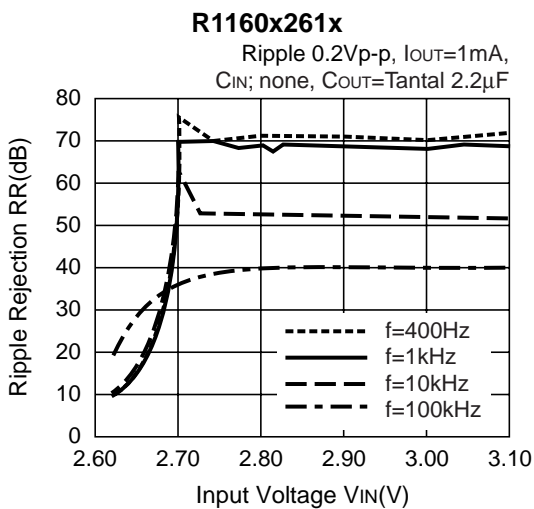

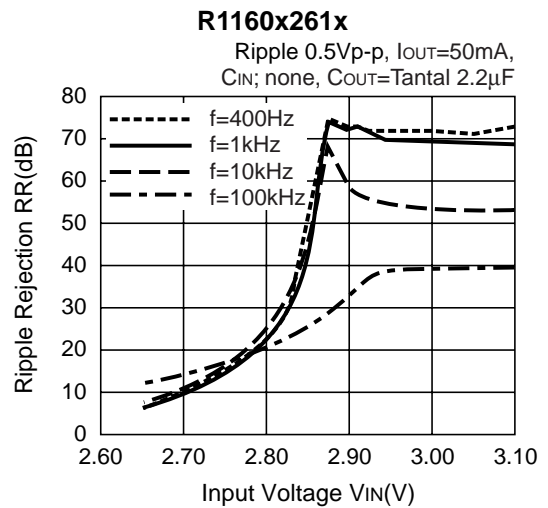
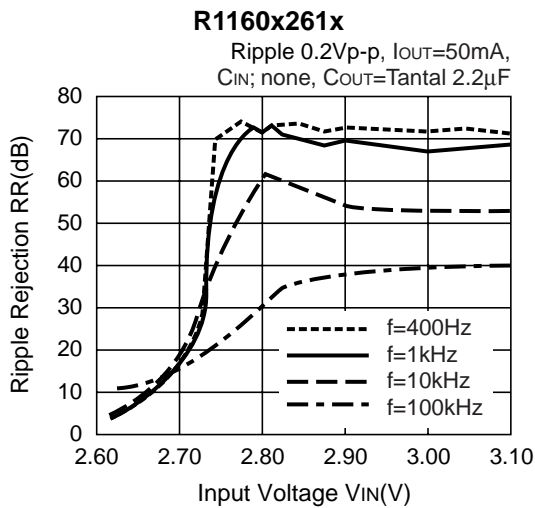
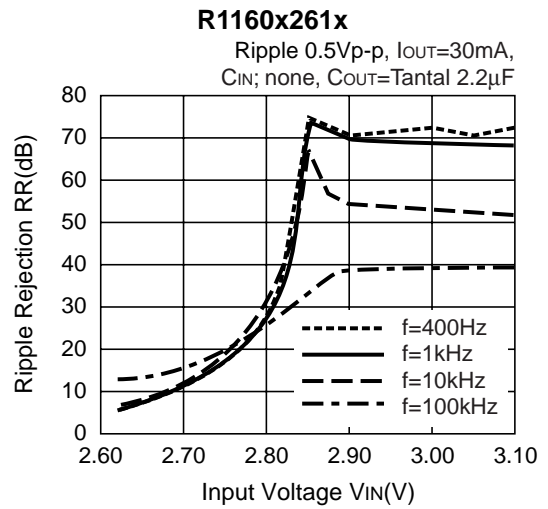
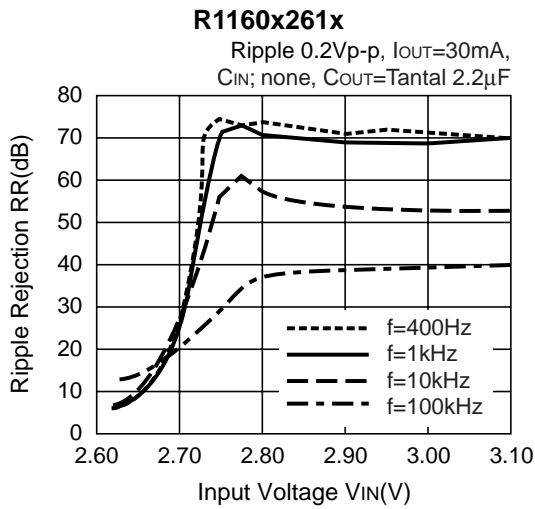

9) Ripple Rejection vs. Frequency

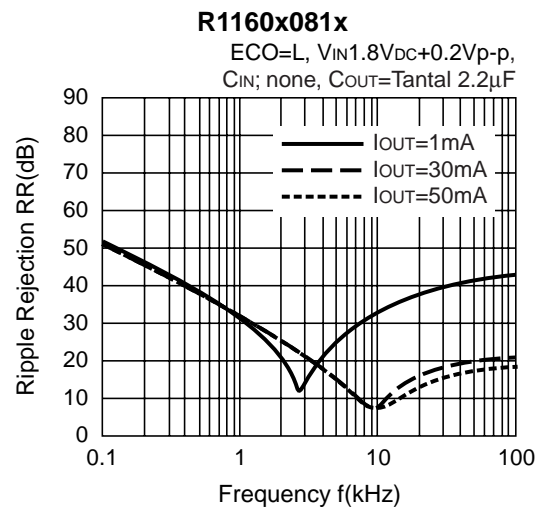
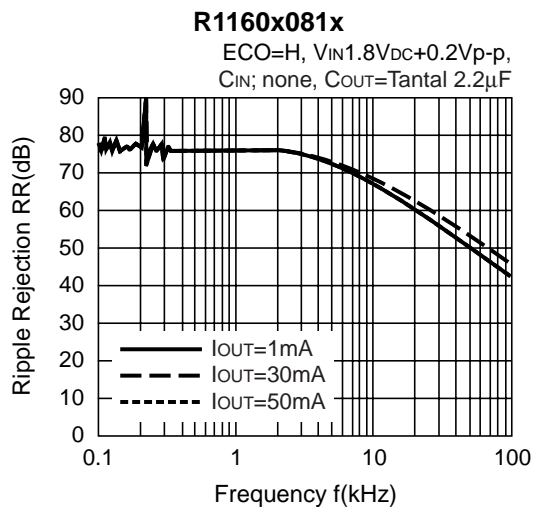

R1160x

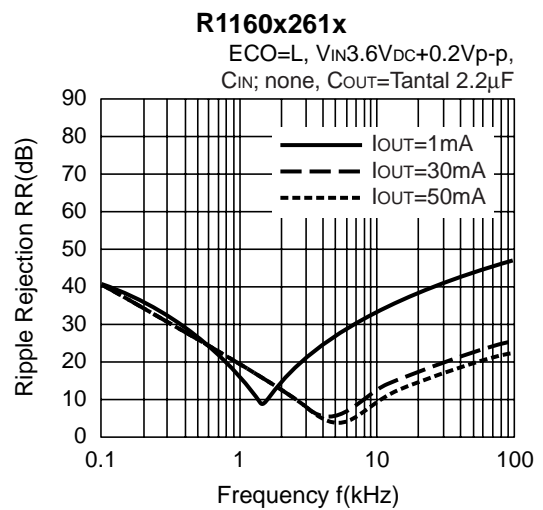
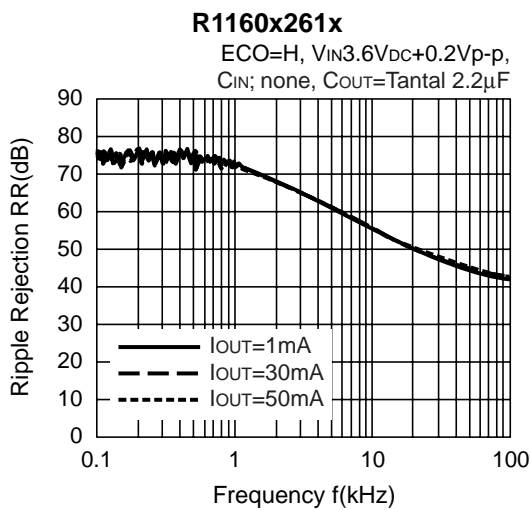
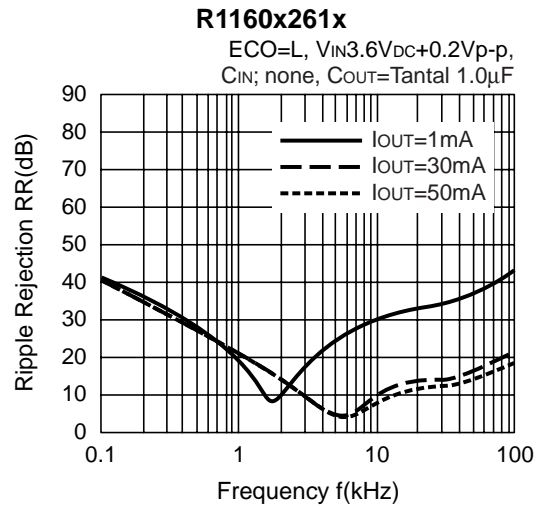
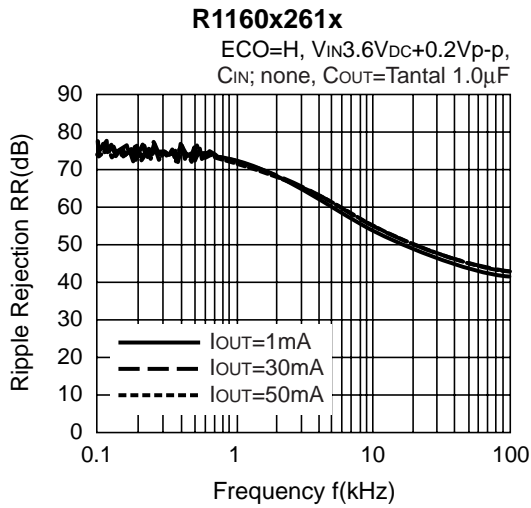
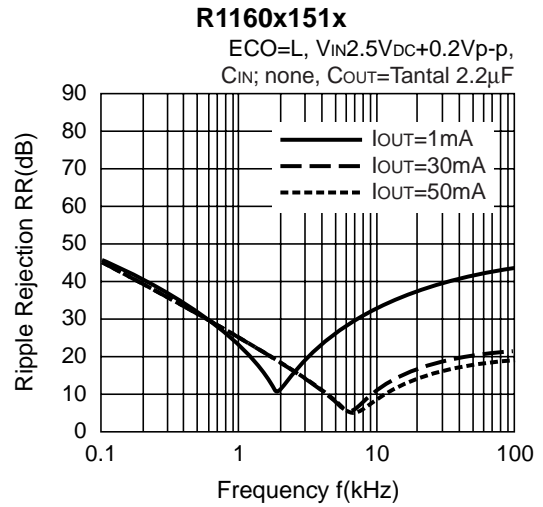
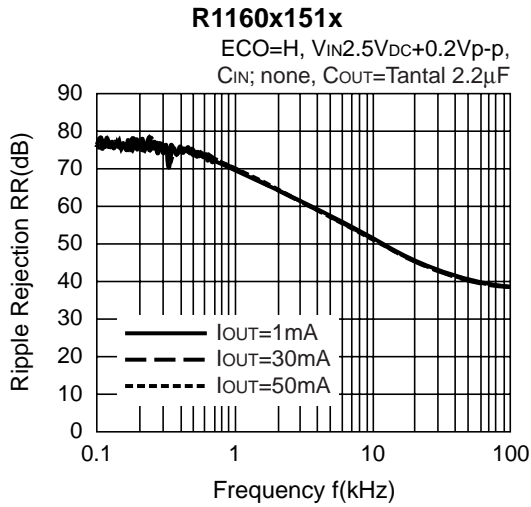

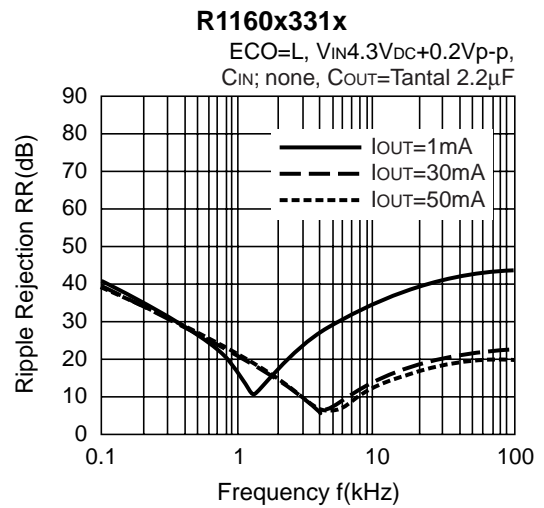
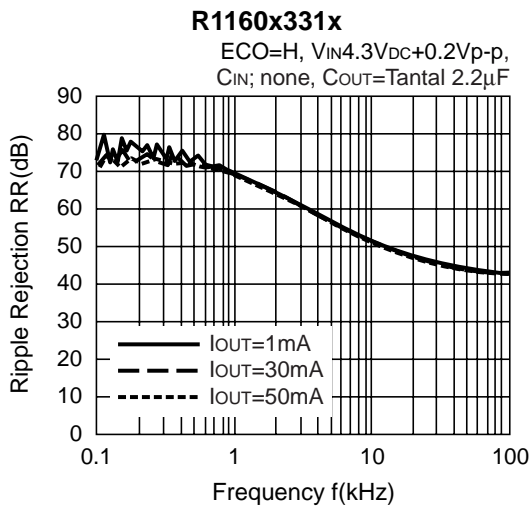
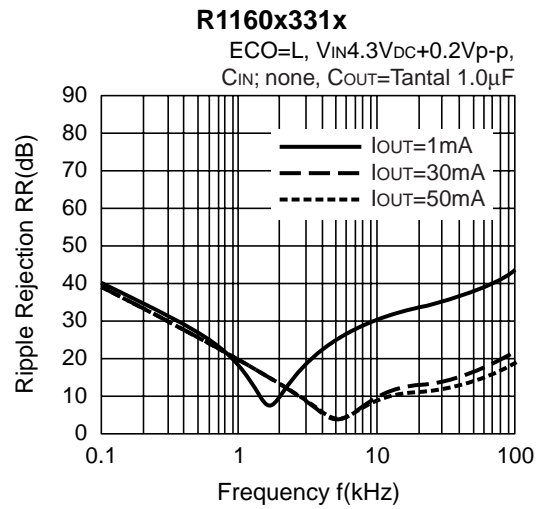
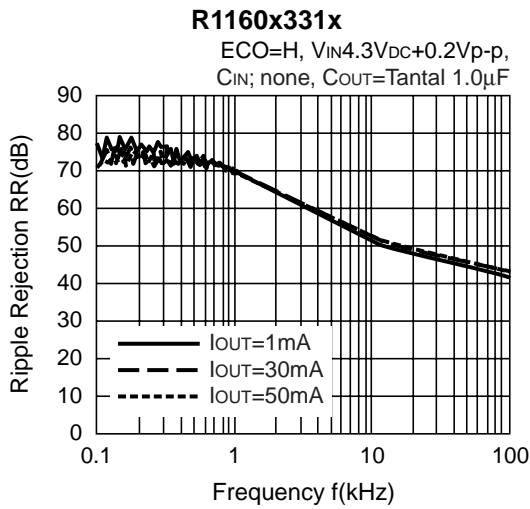

10) Input Transient Response

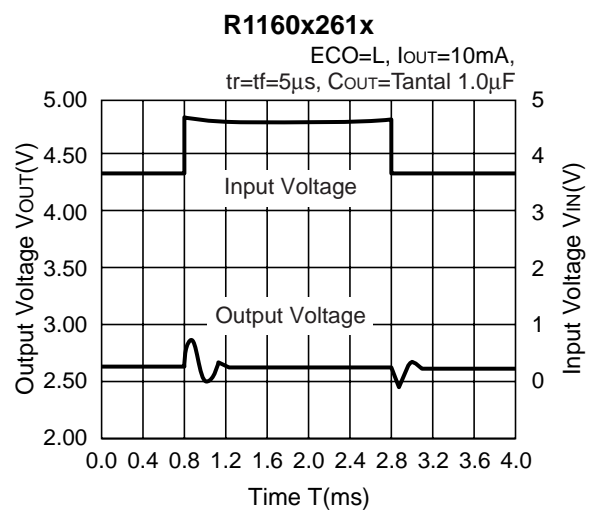
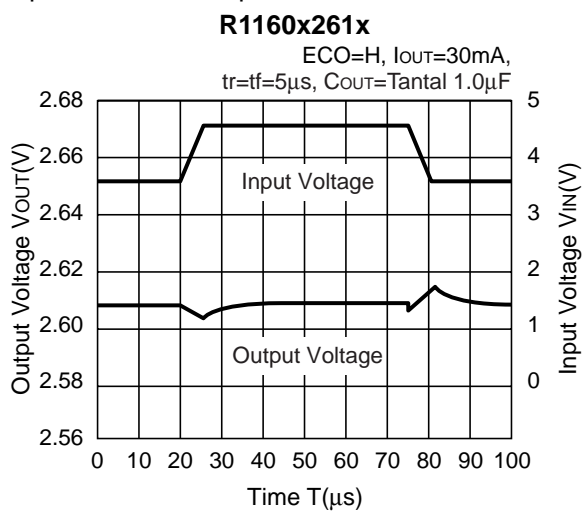

R1160x

11) Load Transient Response

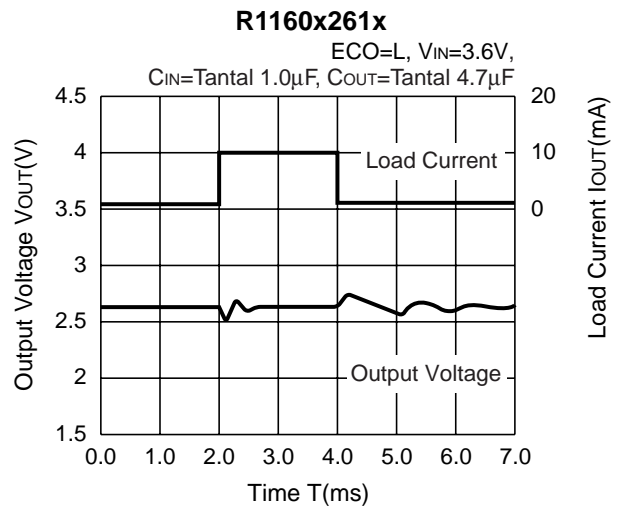
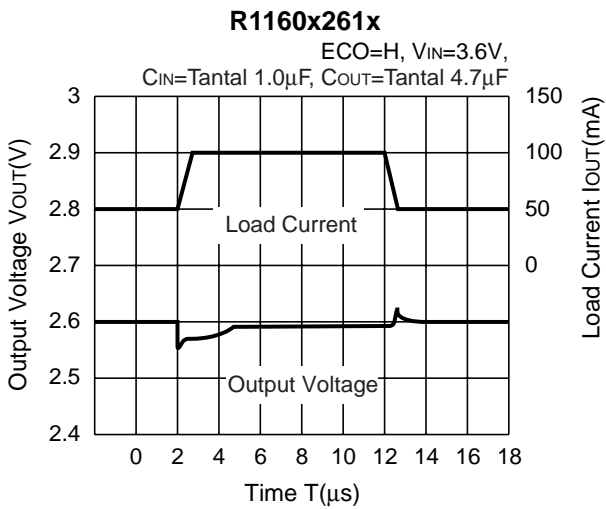
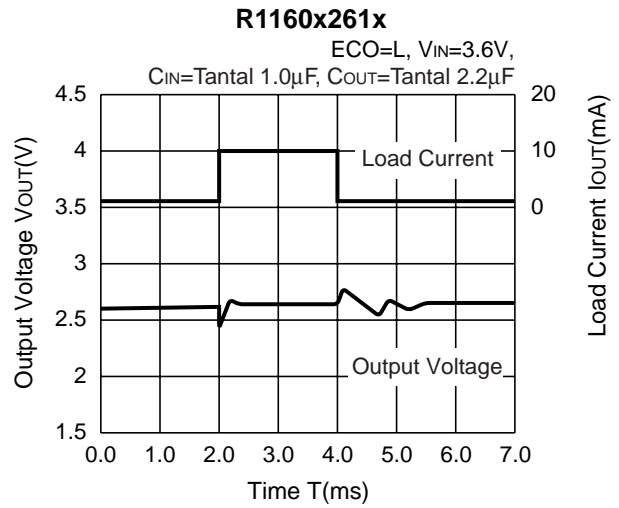
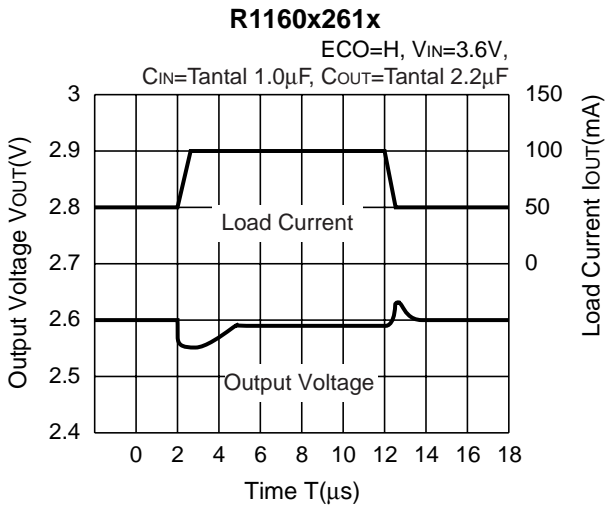
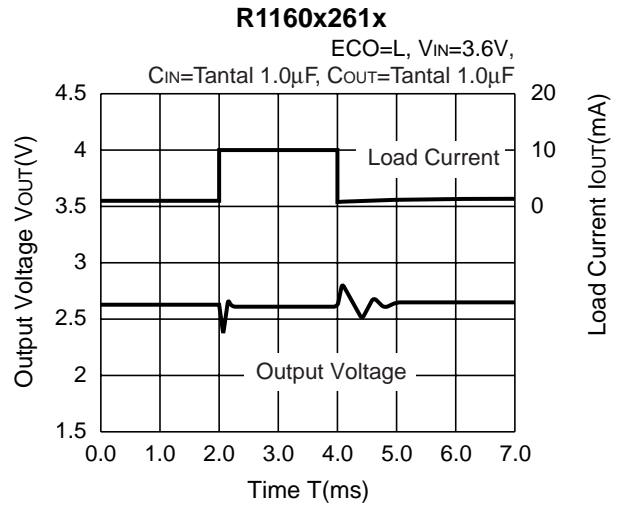
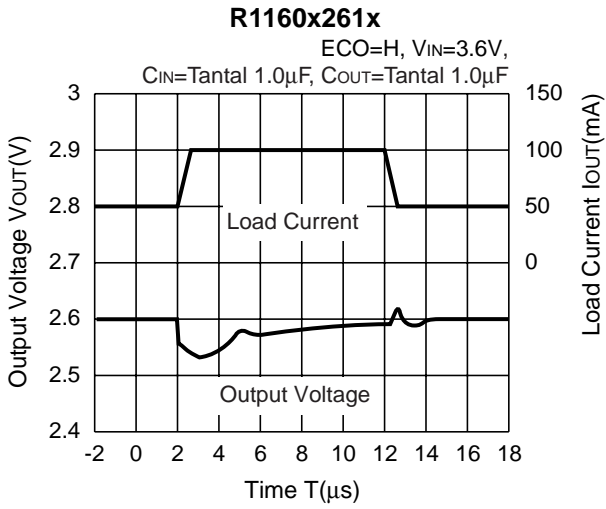

12) Turn on speed with CE pin

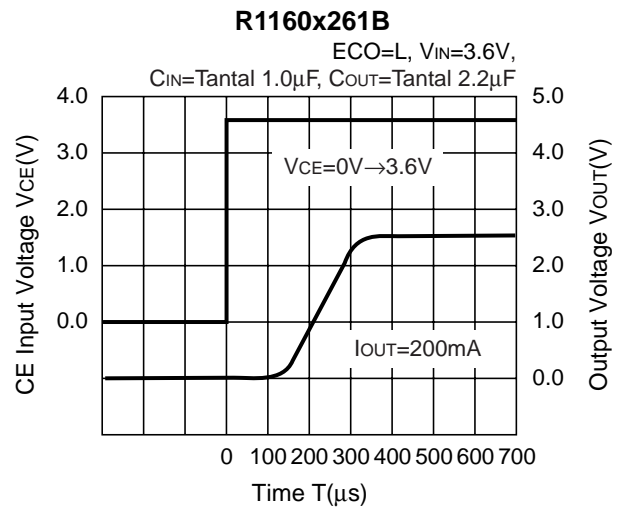
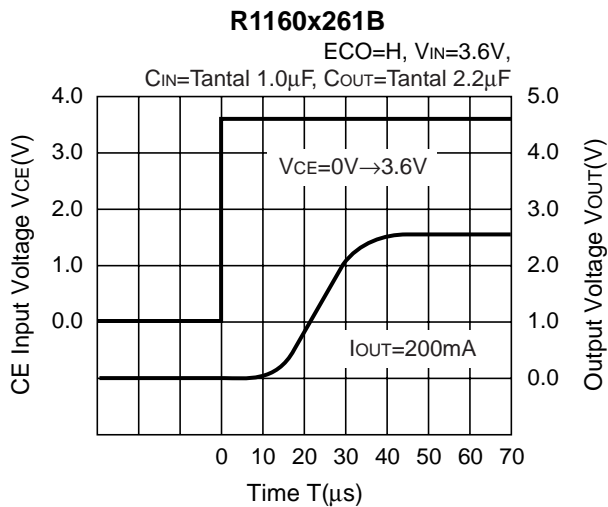
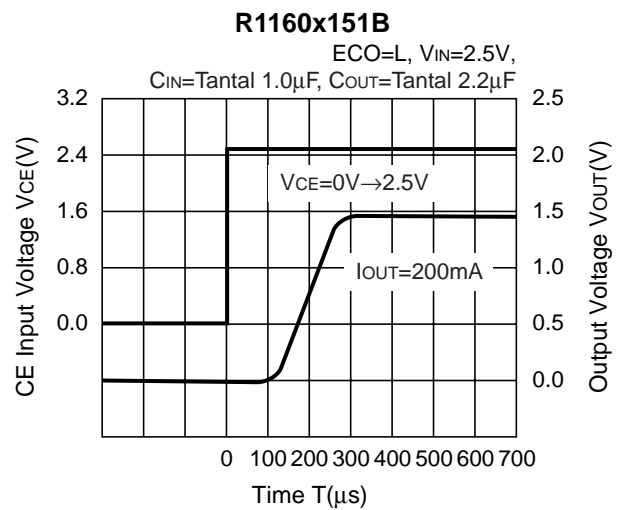
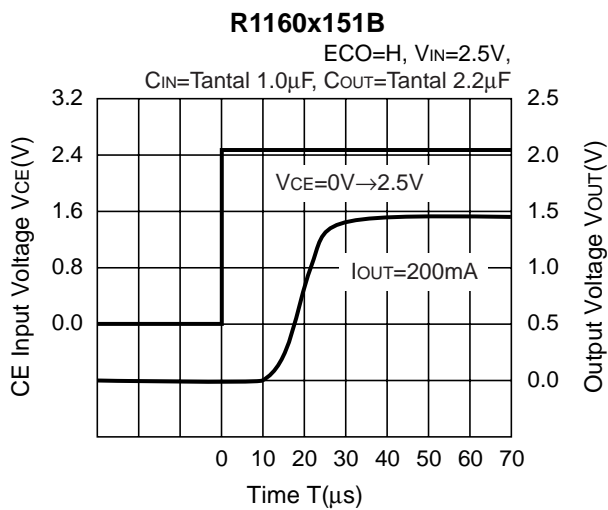
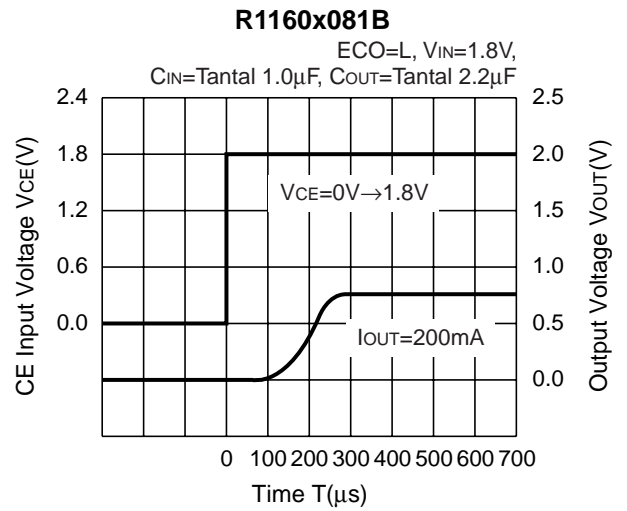
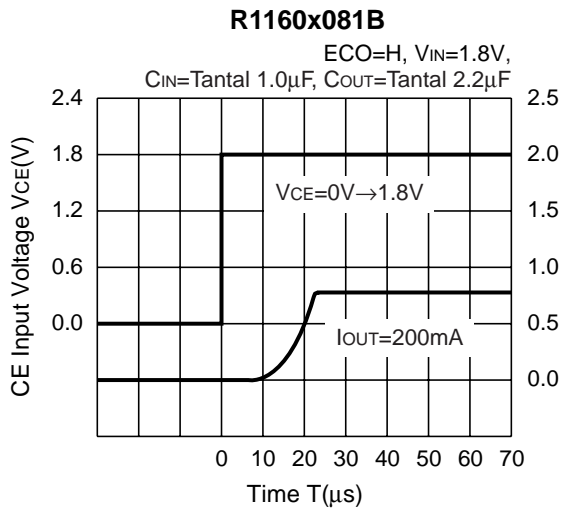

R1160x

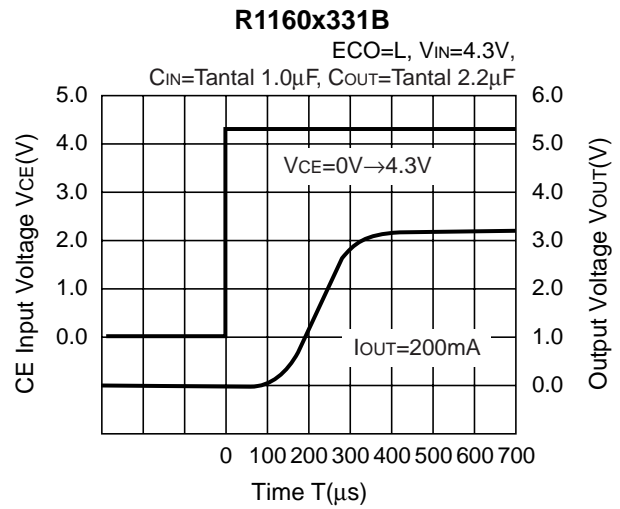
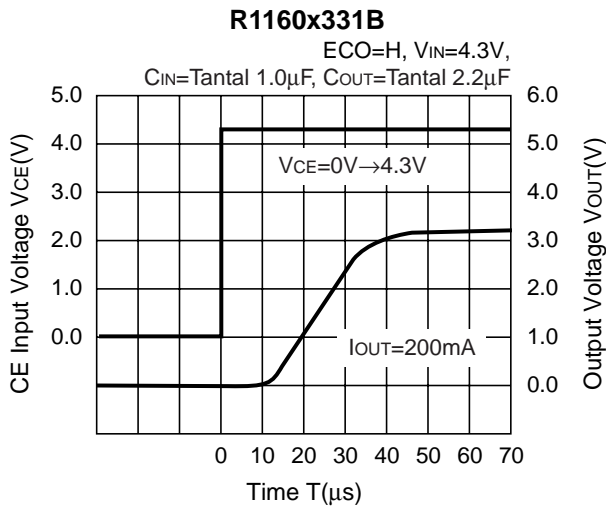

13) Output Voltage at Mode alternative point

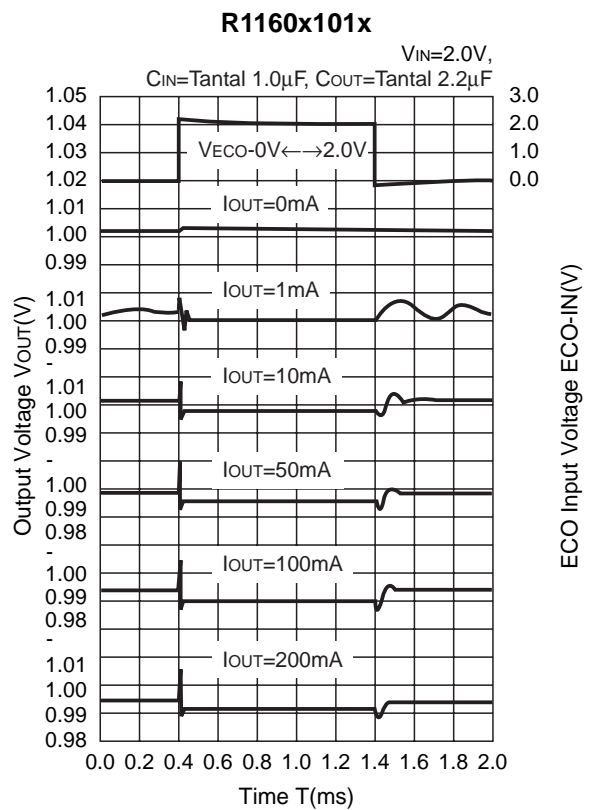
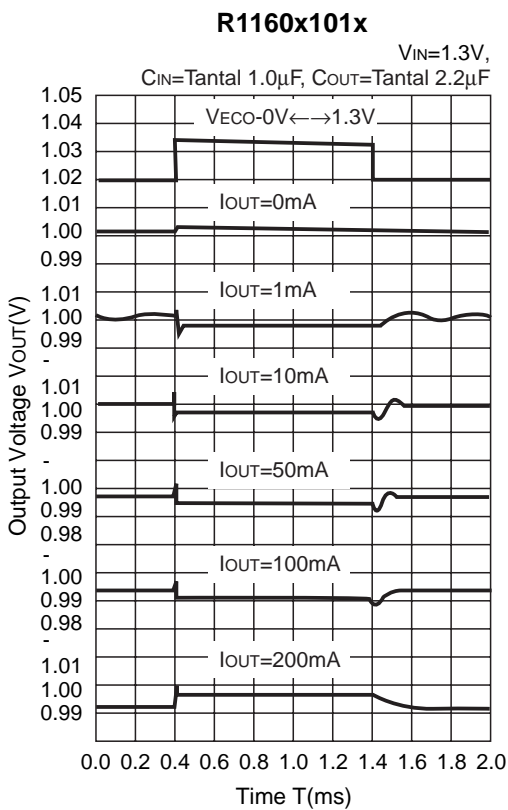

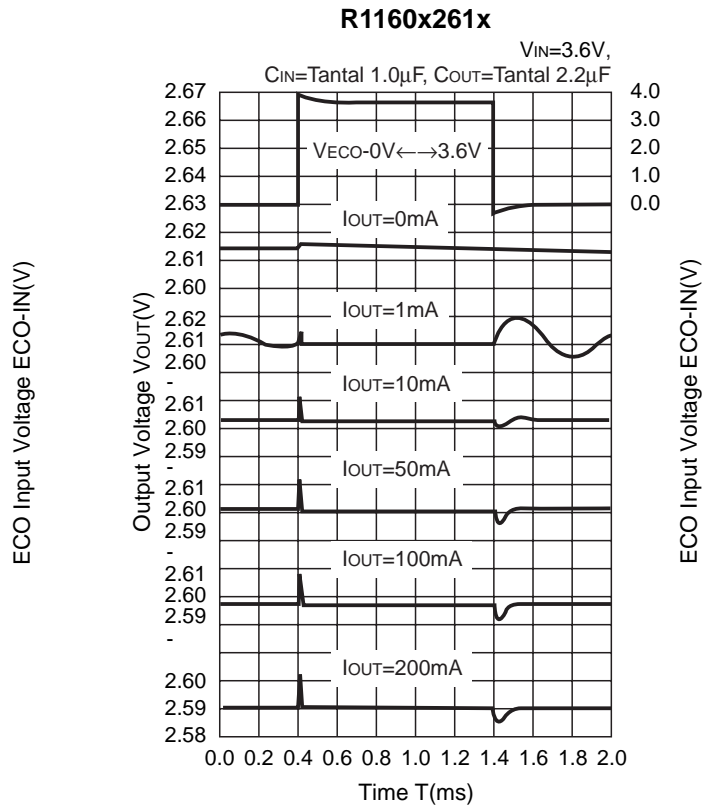
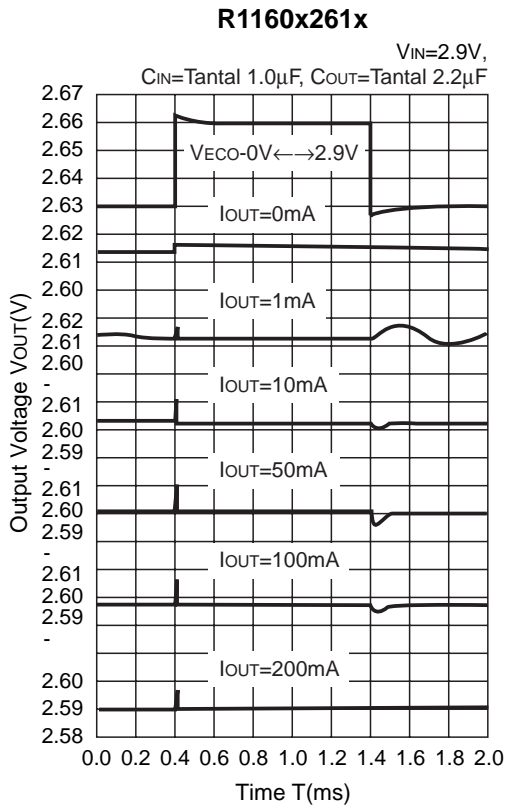

R1160x

TECHNICAL NOTES

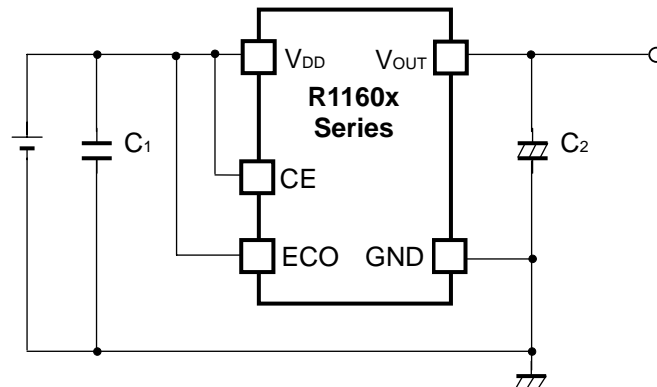

(External Components)

C1: Ceramic Capacitor 1 μ F

C2: Tantalum Capacitor 2.2 μ F

When using these ICs, consider the following points:

1. PCB Layout

Make V_{DD} and GND lines sufficient. If their impedance is high, noise pickup or unstable operation may result. Connect a capacitor C1 with a capacitance value as much as 1.0 μ F or more between V_{DD} and GND pin, and as close as possible to the pins.

Set external components, especially the output capacitor C2, as close as possible to the ICs, and make wiring as short as possible.

2. Phase Compensation

In these ICs, phase compensation is made for securing stable operation even if the load current is varied. For this purpose, use a capacitor C2 with 2.2 μ F or more and good ESR (Equivalent Series Resistance).

(Note: If additional ceramic capacitors are connected with parallel to the output pin with an output capacitor for phase compensation, the operation might be unstable. Because of this, test these ICs with as same external components as ones to be used on the PCB.)

If you use a tantalum type capacitor and ESR value of the capacitor is large, output might be unstable. Evaluate your circuit with considering frequency characteristics.

If you use a ceramic type output capacitor, please connect about 1 Ω resistor in series for the stability of output voltage.

Depending on the capacitor size, manufacturer, and part number, the bias characteristics and temperature characteristics are different. Evaluate the circuit with actual using capacitors.

ESR vs. Output Current

When using these ICs, consider the following points:

The relations between I_{OUT} (Output Current) and ESR of an output capacitor are shown below.

The conditions when the white noise level is under $40\mu V$ (Avg.) are marked as the hatched area in the graph.

Measurement conditions

Frequency Band : 10Hz to 2MHz

Temperature : 25°C

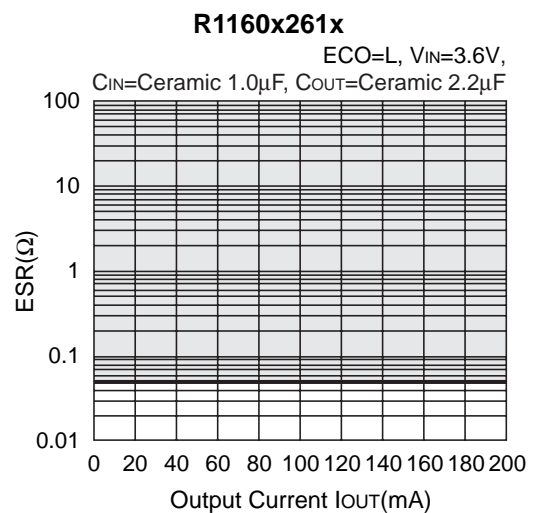
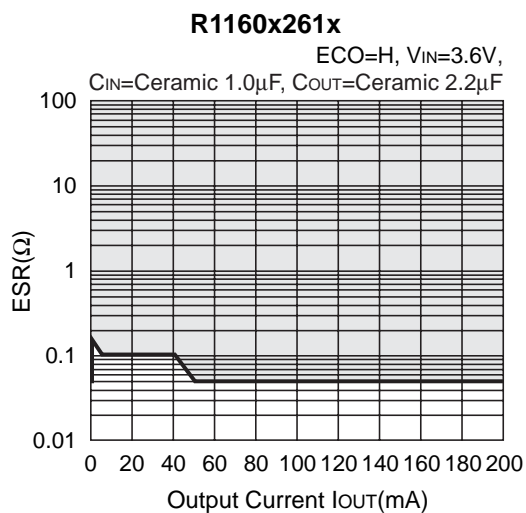
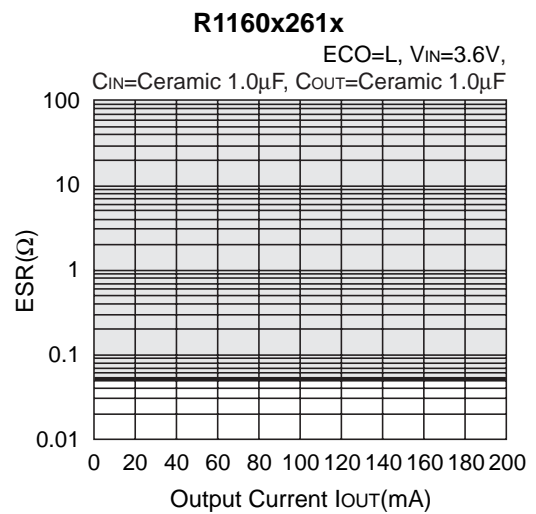
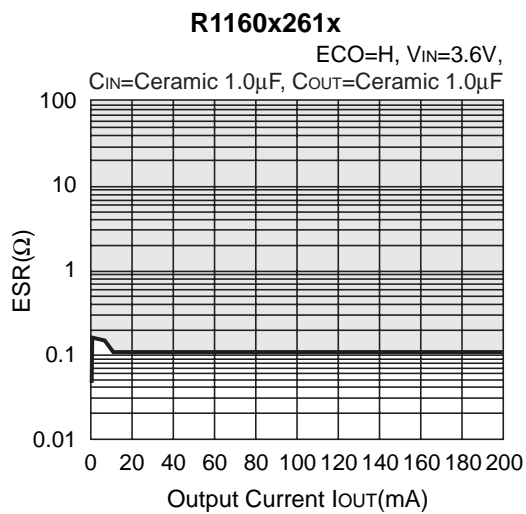

* R1160D (SON-6) is the discontinued product. As of March in 2015.

R1160x

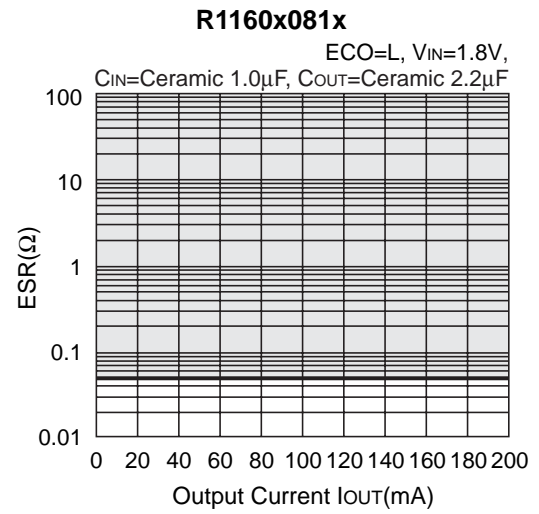
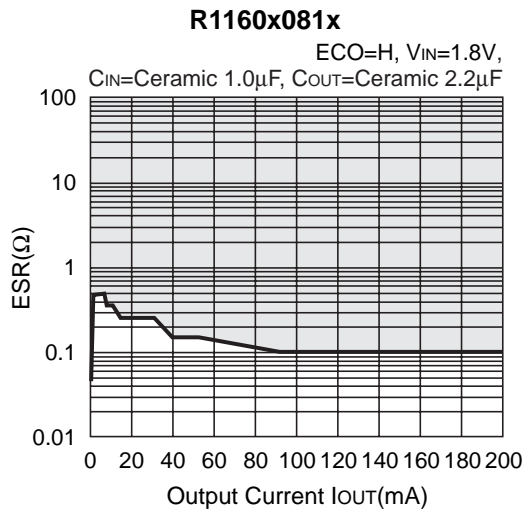



1. The products and the product specifications described in this document are subject to change or discontinuation of production without notice for reasons such as improvement. Therefore, before deciding to use the products, please refer to Ricoh sales representatives for the latest information thereon.
2. The materials in this document may not be copied or otherwise reproduced in whole or in part without prior written consent of Ricoh.
3. Please be sure to take any necessary formalities under relevant laws or regulations before exporting or otherwise taking out of your country the products or the technical information described herein.
4. The technical information described in this document shows typical characteristics of and example application circuits for the products. The release of such information is not to be construed as a warranty of or a grant of license under Ricoh's or any third party's intellectual property rights or any other rights.
5. The products listed in this document are intended and designed for use as general electronic components in standard applications (office equipment, telecommunication equipment, measuring instruments, consumer electronic products, amusement equipment etc.). Those customers intending to use a product in an application requiring extreme quality and reliability, for example, in a highly specific application where the failure or misoperation of the product could result in human injury or death (aircraft, spacevehicle, nuclear reactor control system, traffic control system, automotive and transportation equipment, combustion equipment, safety devices, life support system etc.) should first contact us.
6. We are making our continuous effort to improve the quality and reliability of our products, but semiconductor products are likely to fail with certain probability. In order to prevent any injury to persons or damages to property resulting from such failure, customers should be careful enough to incorporate safety measures in their design, such as redundancy feature, fire containment feature and fail-safe feature. We do not assume any liability or responsibility for any loss or damage arising from misuse or inappropriate use of the products.
7. Anti-radiation design is not implemented in the products described in this document.
8. Please contact Ricoh sales representatives should you have any questions or comments concerning the products or the technical information.



Ricoh is committed to reducing the environmental loading materials in electrical devices with a view to contributing to the protection of human health and the environment.

Ricoh has been providing RoHS compliant products since April 1, 2006 and Halogen-free products since April 1, 2012.

RICOH RICOH ELECTRONIC DEVICES CO., LTD.

<http://www.e-devices.ricoh.co.jp/en/>

Sales & Support Offices

RICOH ELECTRONIC DEVICES CO., LTD.

Higashi-Shinagawa Office (International Sales)
3-32-3, Higashi-Shinagawa, Shinagawa-ku, Tokyo 140-8655, Japan
Phone: +81-3-5479-2857 Fax: +81-3-5479-0502

RICOH EUROPE (NETHERLANDS) B.V.

Semiconductor Support Centre
Prof. W.H. Keesomlaan 1, 1183 DJ Amstelveen, The Netherlands
Phone: +31-20-5474-309

RICOH ELECTRONIC DEVICES KOREA CO., LTD.

3F, Haesung Bldg. 504, Teheran-ro, Gangnam-gu, Seoul, 135-725, Korea
Phone: +82-2-2135-5700 Fax: +82-2-2051-5713

RICOH ELECTRONIC DEVICES SHANGHAI CO., LTD.

Room 403, No.2 Building, No.690 Bilbo Road, Pu Dong New District, Shanghai 201203,
People's Republic of China
Phone: +86-21-5027-3200 Fax: +86-21-5027-3299

RICOH ELECTRONIC DEVICES CO., LTD.

Taipei office
Room 109, 10F-1, No.51, Hengyang Rd., Taipei City, Taiwan (R.O.C.)
Phone: +886-2-2313-1621/1622 Fax: +886-2-2313-1623