

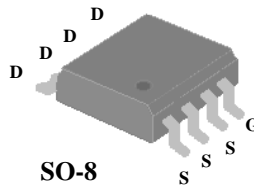

- ▼ Low On Resistance
- ▼ Capable of 2.5V Drive
- ▼ Fast Switching Characteristic
- ▼ RoHS Compliant & Halogen-Free



BV_{DSS}	-20V
$R_{DS(ON)}$	20m Ω
I_D	-9.5A

Description

AP9620 series are from Advanced Power innovated design and silicon process technology to achieve the lowest possible on-resistance and fast switching performance. It provides the designer with an extreme efficient device for use in a wide range of power applications.

The SO-8 package is widely preferred for all commercial-industrial surface mount applications using infrared reflow technique and suited for voltage conversion or switch applications.

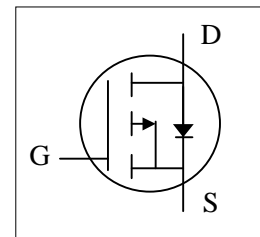

Absolute Maximum Ratings @ $T_J=25^\circ\text{C}$ (unless otherwise specified)

Symbol	Parameter	Rating	Units
V_{DS}	Drain-Source Voltage	-20	V
V_{GS}	Gate-Source Voltage	± 8	V
$I_D @ T_A=25^\circ\text{C}$	Drain Current, $V_{GS} @ 4.5V^3$	-9.5	A
$I_D @ T_A=70^\circ\text{C}$	Drain Current, $V_{GS} @ 4.5V^3$	-7.6	A
I_{DM}	Pulsed Drain Current ¹	-76	A
$P_D @ T_A=25^\circ\text{C}$	Total Power Dissipation	2.5	W
	Linear Derating Factor	0.02	W/ $^\circ\text{C}$
T_{STG}	Storage Temperature Range	-55 to 150	$^\circ\text{C}$
T_J	Operating Junction Temperature Range	-55 to 150	$^\circ\text{C}$

Thermal Data

Symbol	Parameter	Value	Unit
Rthj-amb	Maximum Thermal Resistance, Junction-ambient ³	50	$^\circ\text{C}/\text{W}$



AP9620GM-HF

Electrical Characteristics @ $T_j=25^\circ\text{C}$ (unless otherwise specified)

Symbol	Parameter	Test Conditions	Min.	Typ.	Max.	Units
BV_{DSS}	Drain-Source Breakdown Voltage	$V_{GS}=0V, I_D=-250\mu A$	-20	-	-	V
$R_{DS(ON)}$	Static Drain-Source On-Resistance ²	$V_{GS}=-4.5V, I_D=-9.5A$	-	-	20	m Ω
		$V_{GS}=-2.5V, I_D=-6.0A$	-	-	35	m Ω
$V_{GS(th)}$	Gate Threshold Voltage	$V_{DS}=V_{GS}, I_D=-250\mu A$	-	-	-1	V
g_{fs}	Forward Transconductance	$V_{DS}=-10V, I_D=-9.5A$	-	28	-	S
I_{DSS}	Drain-Source Leakage Current	$V_{DS}=-20V, V_{GS}=0V$	-	-	-1	μA
	Drain-Source Leakage Current ($T_j=70^\circ\text{C}$)	$V_{DS}=-16V, V_{GS}=0V$	-	-	-25	μA
I_{GSS}	Gate-Source Leakage	$V_{GS}=\pm 8V$	-	-	± 100	nA
Q_g	Total Gate Charge	$I_D=-9.5A$	-	30	-	nC
Q_{gs}	Gate-Source Charge	$V_{DS}=-10V$	-	6	-	nC
Q_{gd}	Gate-Drain ("Miller") Charge	$V_{GS}=-5V$	-	3.5	-	nC
$t_{d(on)}$	Turn-on Delay Time	$V_{DS}=-10V$	-	26	-	ns
t_r	Rise Time	$I_D=-9.5A$	-	500	-	ns
$t_{d(off)}$	Turn-off Delay Time	$R_G=6\Omega, V_{GS}=-4.5V$	-	70	-	ns
t_f	Fall Time	$R_D=1.05\Omega$	-	300	-	ns
C_{iss}	Input Capacitance	$V_{GS}=0V$	-	2158	-	pF
C_{oss}	Output Capacitance	$V_{DS}=-15V$	-	845	-	pF
C_{riss}	Reverse Transfer Capacitance	$f=1.0\text{MHz}$	-	230	-	pF

Source-Drain Diode

Symbol	Parameter	Test Conditions	Min.	Typ.	Max.	Units
I_S	Continuous Source Current (Body Diode)	$V_D=V_G=0V, V_S=-1.2V$	-	-	-2.08	A
V_{SD}	Forward On Voltage ²	$T_j=25^\circ\text{C}, I_S=-2.5A, V_{GS}=0V$	-	-	-1.2	V

Notes:

1. Pulse width limited by Max. junction temperature.
2. Pulse test
3. Surface mounted on 1 in² copper pad of FR4 board, $t \leq 10\text{sec}$; 125 °C/W when mounted on Min. copper pad.

THIS PRODUCT IS SENSITIVE TO ELECTROSTATIC DISCHARGE, PLEASE HANDLE WITH CAUTION.

USE OF THIS PRODUCT AS A CRITICAL COMPONENT IN LIFE SUPPORT OR OTHER SIMILAR SYSTEMS IS NOT AUTHORIZED.

APEC DOES NOT ASSUME ANY LIABILITY ARISING OUT OF THE APPLICATION OR USE OF ANY PRODUCT OR CIRCUIT DESCRIBED HEREIN; NEITHER DOES IT CONVEY ANY LICENSE UNDER ITS PATENT RIGHTS, NOR THE RIGHTS OF OTHERS.

APEC RESERVES THE RIGHT TO MAKE CHANGES WITHOUT FURTHER NOTICE TO ANY PRODUCTS HEREIN TO IMPROVE RELIABILITY, FUNCTION OR DESIGN.

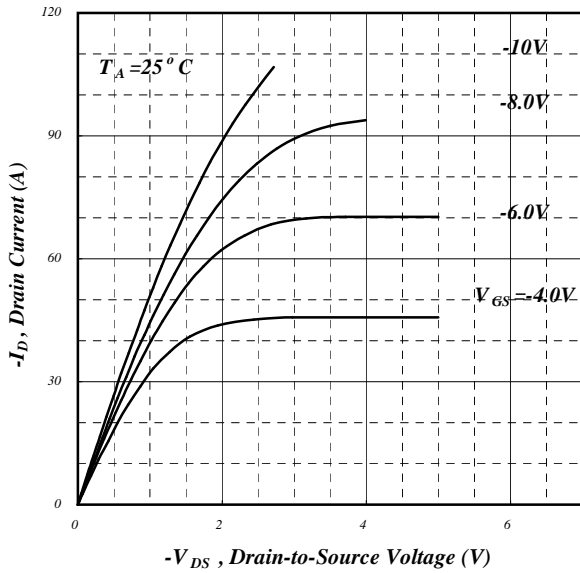

Fig 1. Typical Output Characteristics

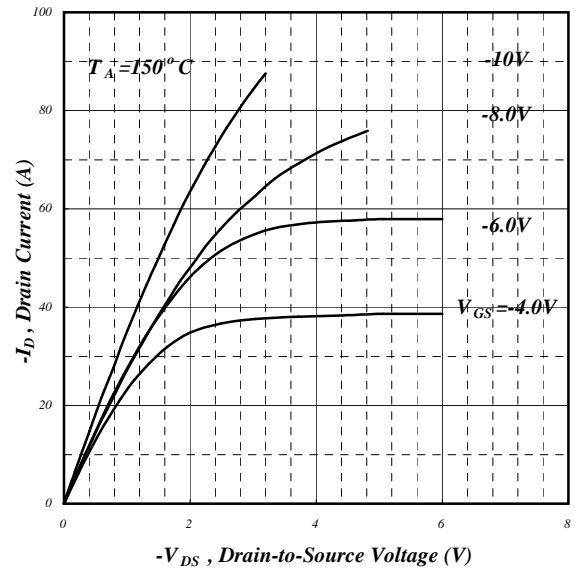

Fig 2. Typical Output Characteristics

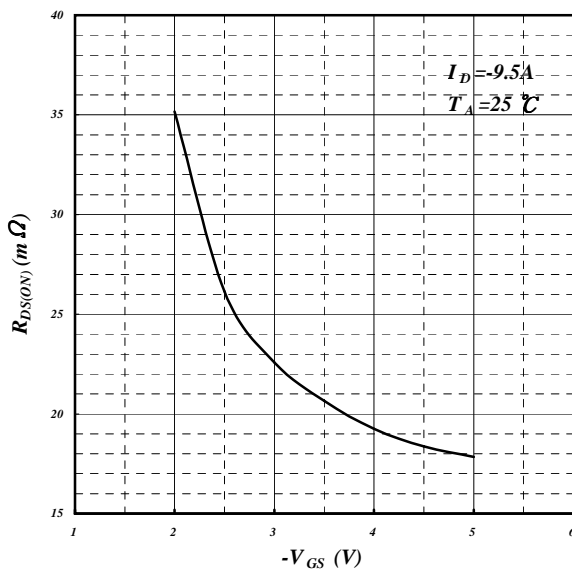

Fig 3. On-Resistance v.s. Gate Voltage

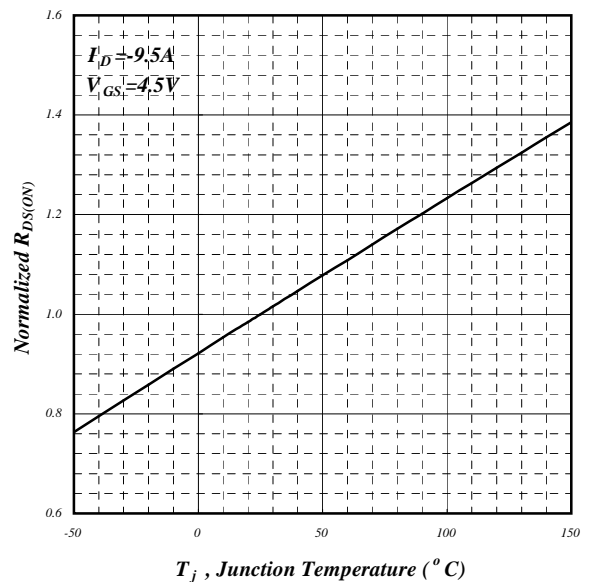

Fig 4. Normalized On-Resistance v.s. Junction Temperature

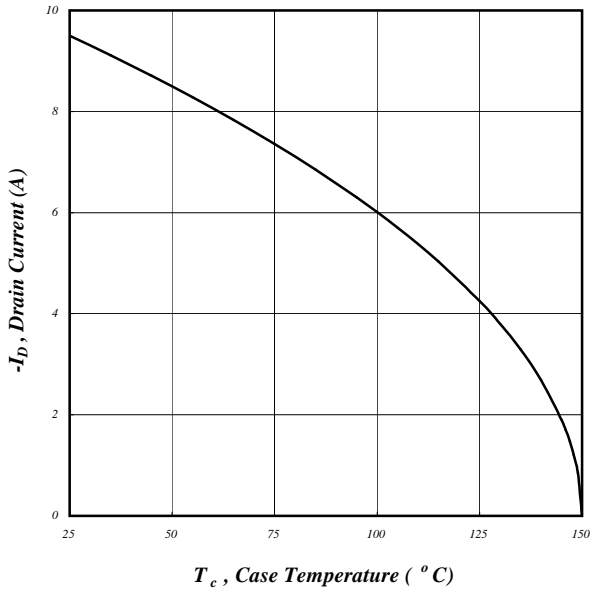

Fig 5. Maximum Drain Current v.s. Case Temperature

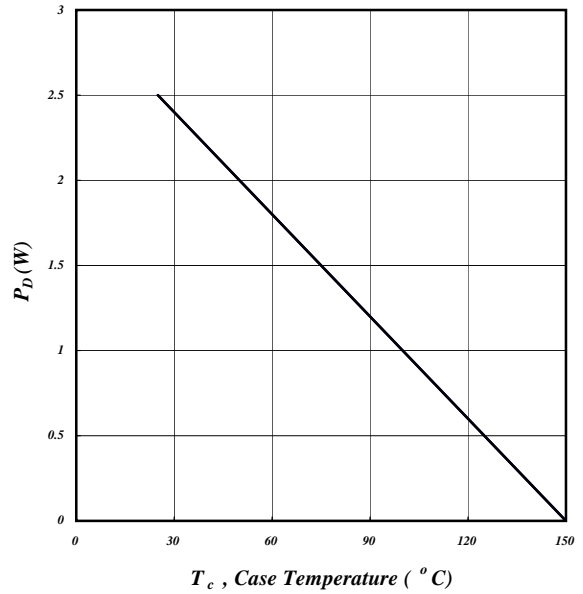

Fig 6. Typical Power Dissipation

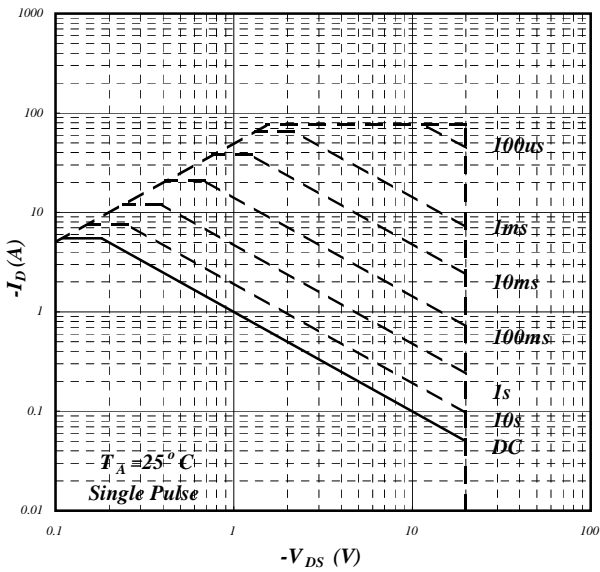

Fig 7. Maximum Safe Operating Area

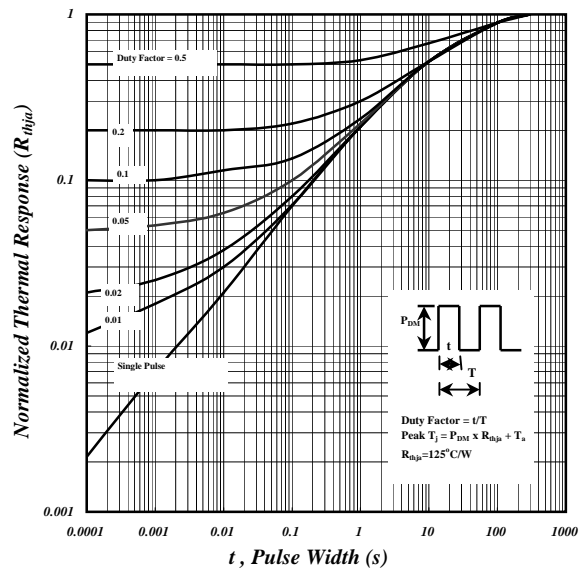

Fig 8. Effective Transient Thermal Impedance

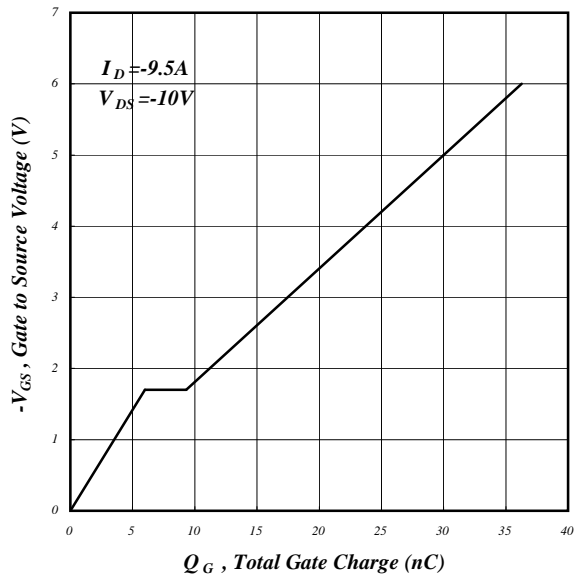

Fig 9. Gate Charge Characteristics

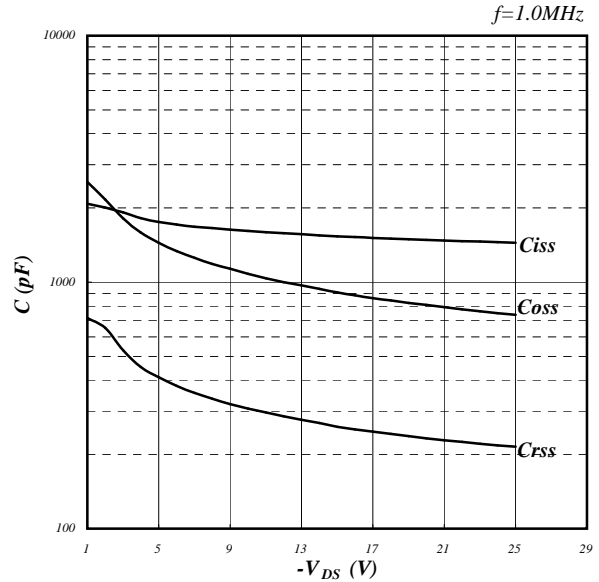

Fig 10. Typical Capacitance Characteristics

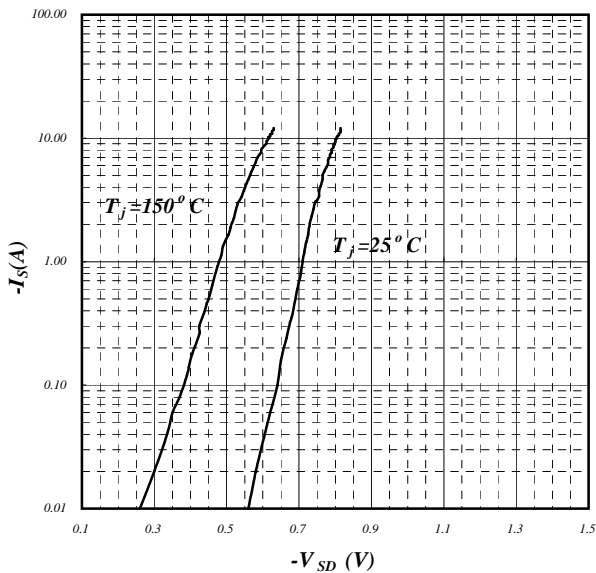

Fig 11. Forward Characteristic of Reverse Diode

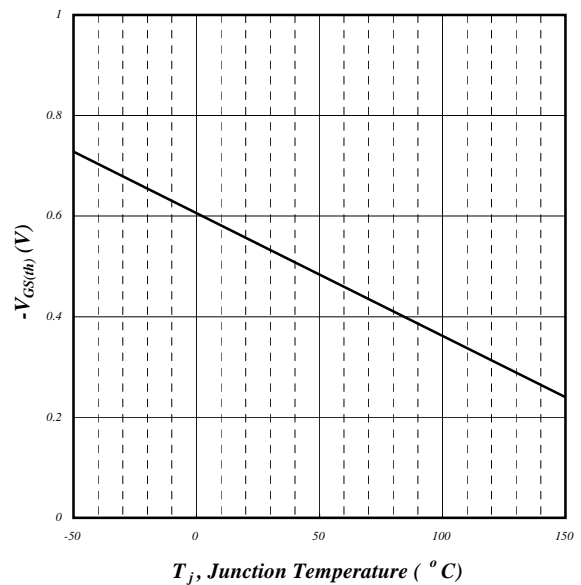

Fig 12. Gate Threshold Voltage v.s. Junction Temperature

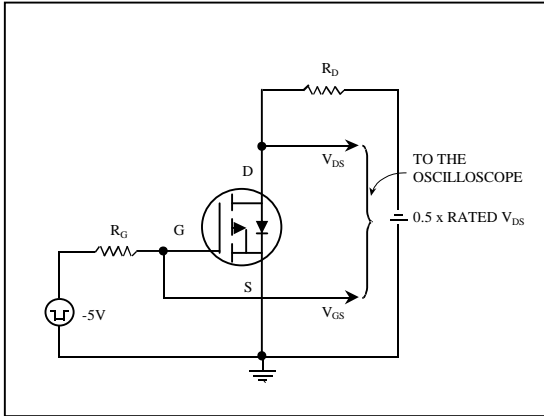

Fig 13. Switching Time Circuit

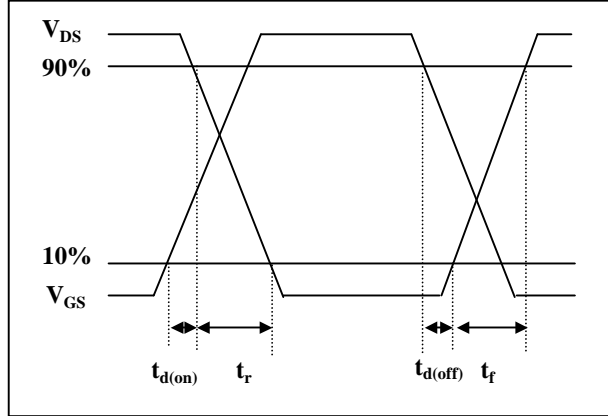

Fig 14. Switching Time Waveform

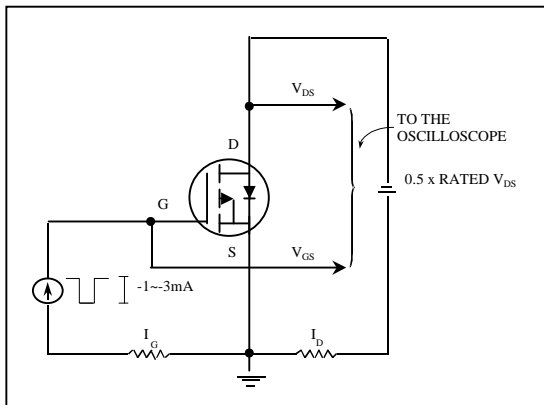

Fig 15. Gate Charge Circuit

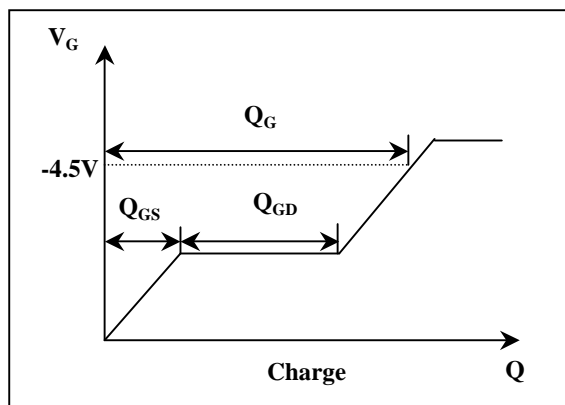

Fig 16. Gate Charge Waveform



MARKING INFORMATION

