

RF Power LDMOS Transistors

N-Channel Enhancement-Mode Lateral MOSFETs

These 100 W symmetrical Doherty RF power LDMOS transistors are designed for cellular base station applications covering the frequency range of 720 to 960 MHz.

- Typical Doherty Single-Carrier W-CDMA Performance: $V_{DD} = 48$ Vdc, $I_{DQA} = 860$ mA, $V_{GSB} = 0.9$ Vdc, $P_{out} = 100$ W Avg., Input Signal PAR = 9.9 dB @ 0.01% Probability on CCDF.

Frequency	G_{ps} (dB)	η_D (%)	Output PAR (dB)	ACPR (dBc)
920 MHz	19.5	48.5	7.2	-29.2
940 MHz	19.5	49.5	7.1	-32.0
960 MHz	19.2	48.0	7.0	-35.7

Features

- Production Tested in a Symmetrical Doherty Configuration
- Greater Negative Gate-Source Voltage Range for Improved Class C Operation
- Designed for Digital Predistortion Error Correction Systems
- In Tape and Reel. R3 Suffix = 250 Units, 32 mm Tape Width, 13-inch Reel.

AFV09P350-04NR3
AFV09P350-04GNR3

720-960 MHz, 100 W AVG., 48 V
AIRFAST RF POWER LDMOS
TRANSISTORS

OM-780-4L
PLASTIC
AFV09P350-04NR3

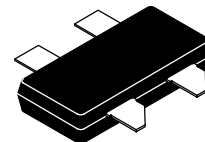

OM-780G-4L
PLASTIC
AFV09P350-04GNR3

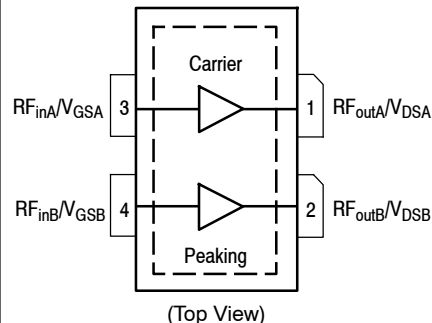
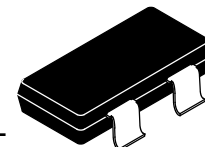

Note: Exposed backside of the package is the source terminal for the transistors.

Figure 1. Pin Connections

Table 1. Maximum Ratings

Rating	Symbol	Value	Unit
Drain-Source Voltage	V_{DSS}	-0.5, +105	Vdc
Gate-Source Voltage	V_{GS}	-6.0, +10	Vdc
Operating Voltage	V_{DD}	55, +0	Vdc
Storage Temperature Range	T_{stg}	-65 to +150	°C
Case Operating Temperature Range	T_C	-40 to +150	°C
Operating Junction Temperature Range ^(1,2)	T_J	-40 to +225	°C

Table 2. Thermal Characteristics

Characteristic	Symbol	Value (2,3)	Unit
Thermal Resistance, Junction to Case Case Temperature 86°C, 102 W W-CDMA, 48 Vdc, $I_{DQA} = 860$ mA, $V_{GSB} = 0.9$ Vdc, 940 MHz	$R_{\theta JC}$	0.45	°C/W

Table 3. ESD Protection Characteristics

Test Methodology	Class
Human Body Model (per JESD22-A114)	1C
Machine Model (per EIA/JESD22-A115)	A
Charge Device Model (per JESD22-C101)	IV

Table 4. Moisture Sensitivity Level

Test Methodology	Rating	Package Peak Temperature	Unit
Per JESD22-A113, IPC/JEDEC J-STD-020	3	260	°C

Table 5. Electrical Characteristics ($T_A = 25^\circ\text{C}$ unless otherwise noted)

Characteristic	Symbol	Min	Typ	Max	Unit
----------------	--------	-----	-----	-----	------

Off Characteristics⁽⁴⁾

Zero Gate Voltage Drain Leakage Current ($V_{DS} = 105$ Vdc, $V_{GS} = 0$ Vdc)	I_{DSS}	—	—	10	μAdc
Zero Gate Voltage Drain Leakage Current ($V_{DS} = 48$ Vdc, $V_{GS} = 0$ Vdc)	I_{DSS}	—	—	1	μAdc
Gate-Source Leakage Current ($V_{GS} = 5$ Vdc, $V_{DS} = 0$ Vdc)	I_{GSS}	—	—	1	μAdc

On Characteristics⁽⁴⁾

Gate Threshold Voltage ($V_{DS} = 10$ Vdc, $I_D = 460$ μAdc)	$V_{GS(th)}$	1.3	1.8	2.3	Vdc
Gate Quiescent Voltage ($V_{DD} = 48$ Vdc, $I_{DA} = 860$ mAdc, Measured in Functional Test)	$V_{GS(Q)}$	2.0	2.5	3.0	Vdc
Drain-Source On-Voltage ($V_{GS} = 10$ Vdc, $I_D = 1.3$ Adc)	$V_{DS(on)}$	0.1	0.21	0.3	Vdc

1. Continuous use at maximum temperature will affect MTTF.
2. MTTF calculator available at <http://www.freescale.com/rf>. Select Software & Tools/Development Tools/Calculators to access MTTF calculators by product.
3. Refer to AN1955, *Thermal Measurement Methodology of RF Power Amplifiers*. Go to <http://www.freescale.com/rf>. Select Documentation/Application Notes - AN1955.
4. Each side of device measured separately.

(continued)

Table 5. Electrical Characteristics ($T_A = 25^\circ\text{C}$ unless otherwise noted) (continued)

Characteristic	Symbol	Min	Typ	Max	Unit
Functional Tests (1,2,3) (In Freescale Doherty Test Fixture, 50 ohm system) $V_{DD} = 48\text{ Vdc}$, $I_{DQA} = 860\text{ mA}$, $V_{GSB} = 0.9\text{ Vdc}$, $P_{out} = 100\text{ W Avg.}$, $f = 920\text{ MHz}$, Single-Carrier W-CDMA, IQ Magnitude Clipping, Input Signal PAR = 9.9 dB @ 0.01% Probability on CCDF. ACPR measured in 3.84 MHz Channel Bandwidth @ $\pm 5\text{ MHz}$ Offset.					
Power Gain	G_{ps}	18.5	19.5	21.5	dB
Drain Efficiency	η_D	45.0	48.5	—	%
Output Peak-to-Average Ratio @ 0.01% Probability on CCDF	PAR	6.6	7.2	—	dB
Adjacent Channel Power Ratio	ACPR	—	-29.2	-27.0	dBc

Load Mismatch (In Freescale Test Fixture, 50 ohm system) $I_{DQA} = 860\text{ mA}$, $V_{GSB} = 0.9\text{ Vdc}$, $f = 940\text{ MHz}$

VSWR 10:1 at 52 Vdc, 500 W Pulsed Output Power (3 dB Input Overdrive from 200 W Pulsed Rated Power)	No Device Degradation
--	-----------------------

Typical Performances (2) (In Freescale Doherty Test Fixture, 50 ohm system) $V_{DD} = 48\text{ Vdc}$, $I_{DQA} = 860\text{ mA}$, $V_{GSB} = 0.9\text{ Vdc}$, 920-960 MHz Bandwidth

P_{out} @ 1 dB Compression Point, CW	P1dB	—	200	—	W
P_{out} @ 3 dB Compression Point (4)	P3dB	—	500	—	W
AM/PM (Maximum value measured at the P3dB compression point across the 920-960 MHz frequency range)	Φ	—	-21	—	°
VBW Resonance Point (IMD Third Order Intermodulation Inflection Point)	VBW_{res}	—	43	—	MHz
Gain Flatness in 40 MHz Bandwidth @ $P_{out} = 100\text{ W Avg.}$	G_F	—	0.3	—	dB
Gain Variation over Temperature (-30°C to +85°C)	ΔG	—	0.01	—	dB/°C
Output Power Variation over Temperature (-30°C to +85°C)	$\Delta P1dB$	—	0.0075	—	dB/°C

1. Part internally input matched.
2. Measurement made with device in a symmetrical Doherty configuration.
3. Measurement made with device in straight lead configuration before any lead forming operation is applied.
4. P3dB = $P_{avg} + 7.0\text{ dB}$ where P_{avg} is the average output power measured using an unclipped W-CDMA single-carrier input signal where output PAR is compressed to 7.0 dB @ 0.01% probability on CCDF.

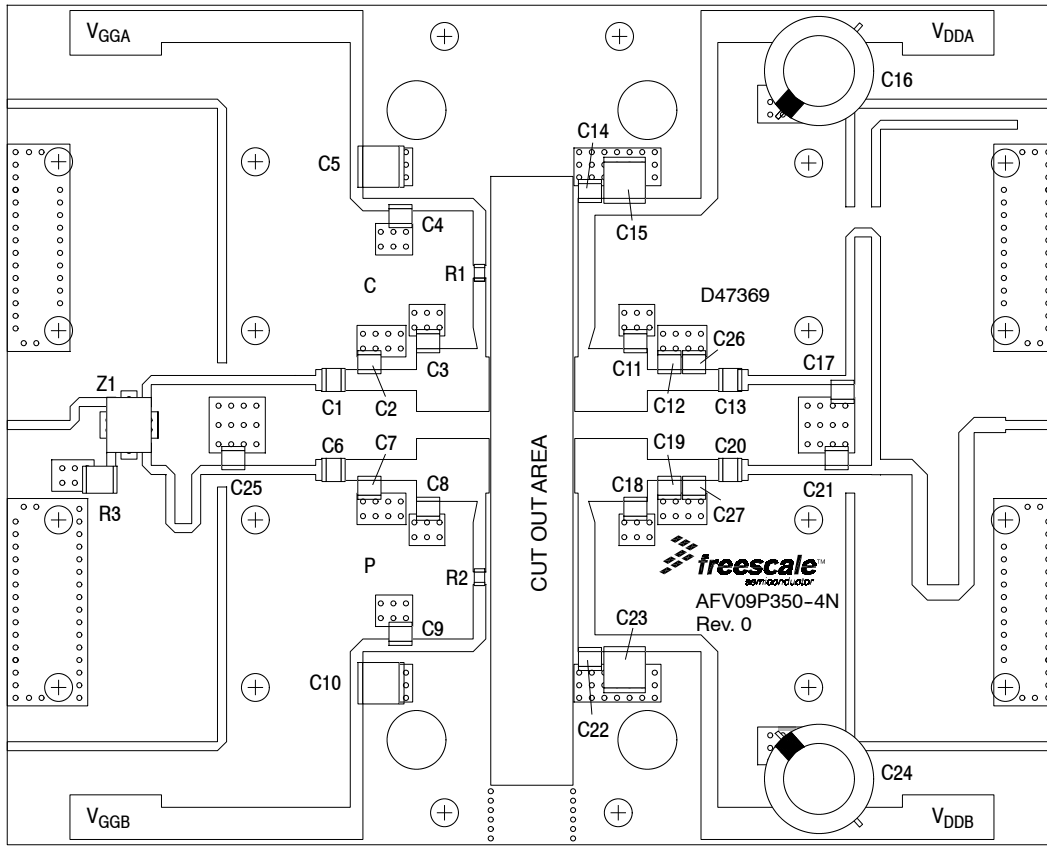

Figure 2. AFV09P350-04NR3 Test Circuit Component Layout

Table 6. AFV09P350-04NR3 Test Circuit Component Designations and Values

Part	Description	Part Number	Manufacturer
C1, C6, C13, C20	33 pF Chip Capacitors	ATC100B330JT500XT	ATC
C2, C7, C17, C21	4.3 pF Chip Capacitors	ATC100B4R3CT500XT	ATC
C3, C8	6.8 pF Chip Capacitors	ATC100B6R8CT500XT	ATC
C4, C9, C14, C22	47 pF Chip Capacitors	ATC100B470JT500XT	ATC
C5, C10	2.2 μ F Chip Capacitors	C3225X7R1H225K250AB	TDK
C11, C18	12 pF Chip Capacitors	ATC100B120JT500XT	ATC
C12, C19	8.2 pF Chip Capacitors	ATC100B8R2CT500XT	ATC
C15, C23	10 μ F Chip Capacitors	C5750X7S2A106M230KB	TDK
C16, C24	220 μ F, 100 V Electrolytic Capacitors	MCGPR100V227M16X26-RH	Multicomp
C25	0.5 pF Chip Capacitor	ATC100B0R5BT500XT	ATC
C26	0.3 pF Chip Capacitor	ATC100B0R3BT500XT	ATC
C27	0.8 pF Chip Capacitor	ATC100B0R8BT500XT	ATC
R1, R2	1.5 Ω , 1/4 W Chip Resistors	RC1206FR-071R5L	Yageo
R3	50 Ω , 30 W Termination	RFP-375375N6Z50-2	Anaren
Z1	800-1000 MHz Band, 90°, 3 dB Hybrid Coupler	X3C09P1-03S	Anaren
PCB	Rogers RO4350B, 0.020", $\epsilon_r = 3.66$	D47369	MTL

TYPICAL CHARACTERISTICS

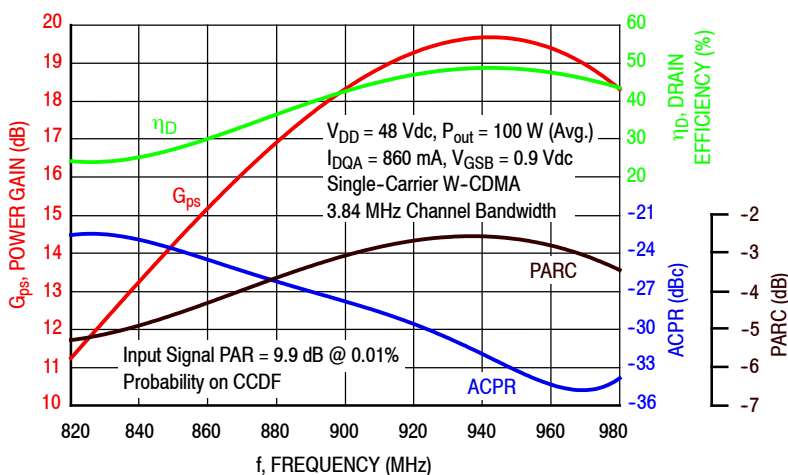

Figure 3. Single-Carrier Output Peak-to-Average Ratio Compression (PARC) Broadband Performance @ $P_{out} = 100$ Watts Avg.

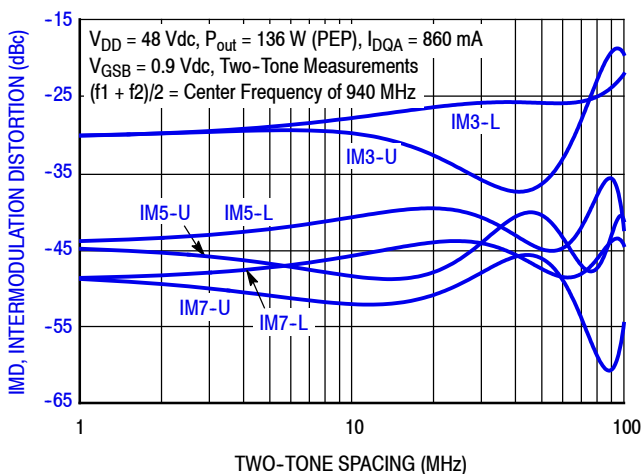

Figure 4. Intermodulation Distortion Products versus Two-Tone Spacing

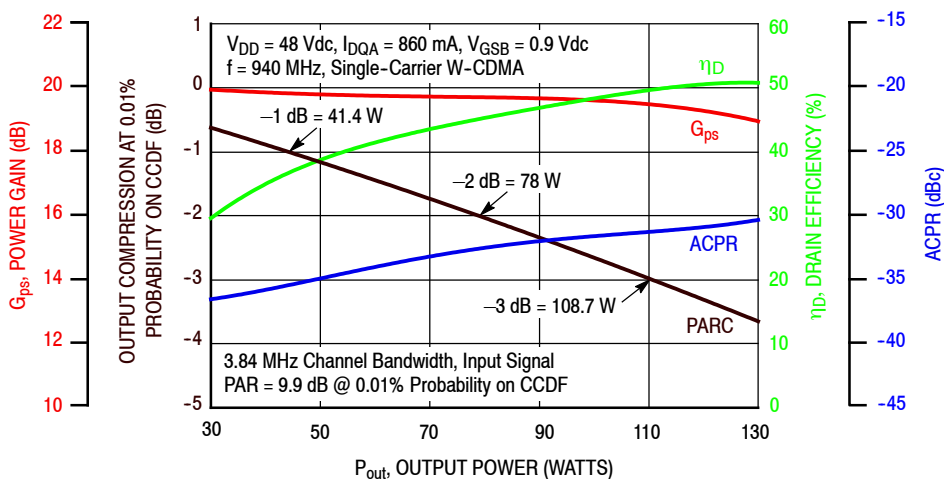

Figure 5. Output Peak-to-Average Ratio Compression (PARC) versus Output Power

TYPICAL CHARACTERISTICS

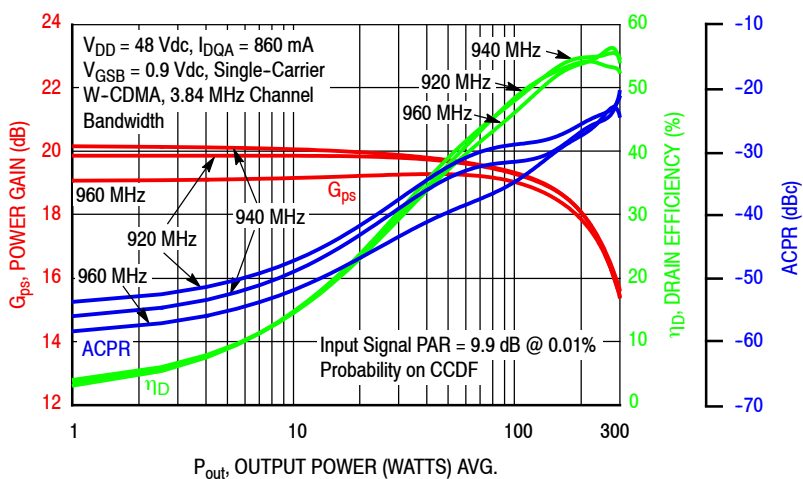

Figure 6. Single-Carrier W-CDMA Power Gain, Drain Efficiency and ACPR versus Output Power

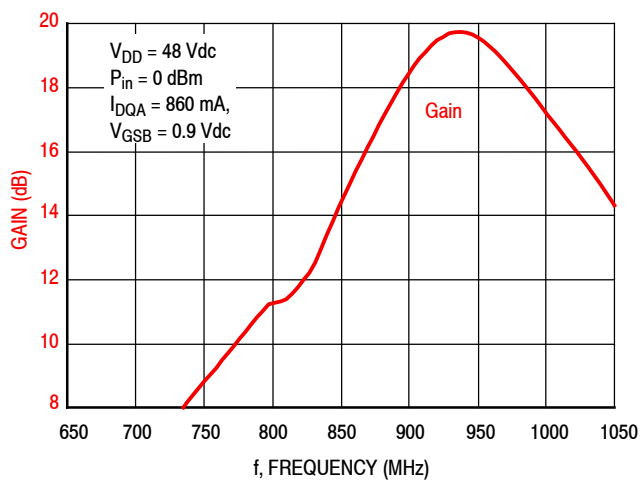

Figure 7. Broadband Frequency Response

Table 7. Carrier Side Load Pull Performance — Maximum Power Tuning
 $V_{DD} = 48 \text{ Vdc}$, $I_{DQ} = 862 \text{ mA}$, Pulsed CW, $10 \mu\text{sec}(\text{on})$, 10% Duty Cycle

f (MHz)	$Z_{\text{source}} (\Omega)$	$Z_{\text{in}} (\Omega)$	Max Output Power					
			P1dB					
			$Z_{\text{load}}^{(1)} (\Omega)$	Gain (dB)	(dBm)	(W)	η_D (%)	AM/PM (°)
920	2.39 – j3.65	2.32 + j3.41	1.84 + j0.12	21.3	54.1	260	59.9	-14
940	2.54 – j4.03	2.49 + j3.84	1.85 + j0.11	21.3	54.1	258	59.9	-14
960	2.90 – j4.64	2.76 + j4.31	1.77 + j0.13	21.2	54.1	259	59.8	-15

f (MHz)	$Z_{\text{source}} (\Omega)$	$Z_{\text{in}} (\Omega)$	Max Output Power					
			P3dB					
			$Z_{\text{load}}^{(2)} (\Omega)$	Gain (dB)	(dBm)	(W)	η_D (%)	AM/PM (°)
920	2.39 – j3.65	2.29 + j3.66	2.11 – j0.03	19.1	54.8	301	61.1	-19
940	2.54 – j4.03	2.45 + j4.12	2.04 – j0.03	19.2	54.8	299	60.8	-18
960	2.90 – j4.64	2.74 + j4.63	1.97 – j0.01	19.1	54.8	300	60.6	-19

(1) Load impedance for optimum P1dB power.

(2) Load impedance for optimum P3dB power.

Z_{source} = Measured impedance presented to the input of the device at the package reference plane.

Z_{in} = Impedance as measured from gate contact to ground.

Z_{load} = Measured impedance presented to the output of the device at the package reference plane.

Table 8. Carrier Side Load Pull Performance — Maximum Drain Efficiency Tuning
 $V_{DD} = 48 \text{ Vdc}$, $I_{DQ} = 862 \text{ mA}$, Pulsed CW, $10 \mu\text{sec}(\text{on})$, 10% Duty Cycle

f (MHz)	$Z_{\text{source}} (\Omega)$	$Z_{\text{in}} (\Omega)$	Max Drain Efficiency					
			P1dB					
			$Z_{\text{load}}^{(1)} (\Omega)$	Gain (dB)	(dBm)	(W)	η_D (%)	AM/PM (°)
920	2.39 – j3.65	2.11 + j3.81	1.51 + j1.85	24.3	51.5	140	71.8	-20
940	2.54 – j4.03	2.27 + j4.24	1.43 + j1.84	24.3	51.4	138	71.9	-21
960	2.90 – j4.64	2.60 + j4.68	1.46 + j1.61	23.8	52.2	164	71.6	-20

f (MHz)	$Z_{\text{source}} (\Omega)$	$Z_{\text{in}} (\Omega)$	Max Drain Efficiency					
			P3dB					
			$Z_{\text{load}}^{(2)} (\Omega)$	Gain (dB)	(dBm)	(W)	η_D (%)	AM/PM (°)
920	2.39 – j3.65	2.22 + j3.95	1.92 + j1.53	21.5	53.2	207	71.6	-25
940	2.54 – j4.03	2.38 + j4.45	1.74 + j1.57	21.7	52.9	197	71.8	-27
960	2.90 – j4.64	2.66 + j4.94	1.59 + j1.48	21.5	53.1	206	72.0	-27

(1) Load impedance for optimum P1dB efficiency.

(2) Load impedance for optimum P3dB efficiency.

Z_{source} = Measured impedance presented to the input of the device at the package reference plane.

Z_{in} = Impedance as measured from gate contact to ground.

Z_{load} = Measured impedance presented to the output of the device at the package reference plane.

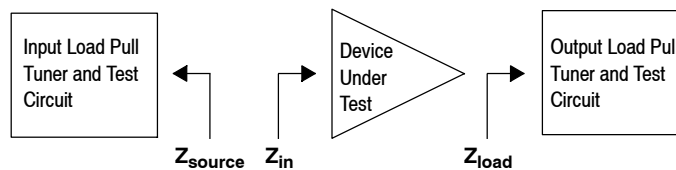

Table 9. Peaking Side Load Pull Performance — Maximum Power Tuning
 $V_{DD} = 48 \text{ Vdc}$, $V_{GSB} = 0.9 \text{ Vdc}$, Pulsed CW, 10 $\mu\text{sec}(\text{on})$, 10% Duty Cycle

f (MHz)	Z_{source} (Ω)	Z_{in} (Ω)	Max Output Power					
			P1dB					
			$Z_{\text{load}}^{(1)}$ (Ω)	Gain (dB)	(dBm)	(W)	η_D (%)	AM/PM ($^\circ$)
920	2.39 – j3.65	2.33 + j3.43	1.52 + j0.07	16.8	54.7	294	66.5	–25
940	2.54 – j4.03	2.44 + j3.87	1.44 + j0.21	16.9	54.6	291	66.9	–25
960	2.90 – j4.64	2.64 + j4.34	1.58 + j0.24	17.0	54.5	283	66.5	–25

f (MHz)	Z_{source} (Ω)	Z_{in} (Ω)	Max Output Power					
			P3dB					
			$Z_{\text{load}}^{(2)}$ (Ω)	Gain (dB)	(dBm)	(W)	η_D (%)	AM/PM ($^\circ$)
920	2.39 – j3.65	2.28 + j3.69	1.68 – j0.06	14.7	55.3	335	66.8	–29
940	2.54 – j4.03	2.40 + j4.15	1.60 + j0.13	14.9	55.2	332	68.0	–30
960	2.90 – j4.64	2.61 + j4.66	1.71 + j0.14	14.9	55.1	325	66.8	–30

(1) Load impedance for optimum P1dB power.

(2) Load impedance for optimum P3dB power.

 Z_{source} = Measured impedance presented to the input of the device at the package reference plane.

 Z_{in} = Impedance as measured from gate contact to ground.

 Z_{load} = Measured impedance presented to the output of the device at the package reference plane.

Table 10. Peaking Side Load Pull Performance — Maximum Drain Efficiency Tuning
 $V_{DD} = 48 \text{ Vdc}$, $V_{GSB} = 0.9 \text{ Vdc}$, Pulsed CW, 10 $\mu\text{sec}(\text{on})$, 10% Duty Cycle

f (MHz)	Z_{source} (Ω)	Z_{in} (Ω)	Max Drain Efficiency					
			P1dB					
			$Z_{\text{load}}^{(1)}$ (Ω)	Gain (dB)	(dBm)	(W)	η_D (%)	AM/PM ($^\circ$)
920	2.39 – j3.65	2.22 + j3.39	1.81 + j1.79	17.5	52.4	174	78.9	–29
940	2.54 – j4.03	2.27 + j3.80	1.35 + j2.23	17.6	51.2	131	81.4	–35
960	2.90 – j4.64	2.43 + j4.27	1.24 + j2.22	17.6	51.2	131	81.6	–36

f (MHz)	Z_{source} (Ω)	Z_{in} (Ω)	Max Drain Efficiency					
			P3dB					
			$Z_{\text{load}}^{(2)}$ (Ω)	Gain (dB)	(dBm)	(W)	η_D (%)	AM/PM ($^\circ$)
920	2.39 – j3.65	2.20 + j3.66	2.07 + j1.45	15.5	53.6	231	77.1	–33
940	2.54 – j4.03	2.31 + j4.12	1.86 + j1.49	15.7	53.6	231	78.9	–36
960	2.90 – j4.64	2.50 + j4.62	1.70 + j1.64	15.8	53.4	218	78.7	–37

(1) Load impedance for optimum P1dB efficiency.

(2) Load impedance for optimum P3dB efficiency.

 Z_{source} = Measured impedance presented to the input of the device at the package reference plane.

 Z_{in} = Impedance as measured from gate contact to ground.

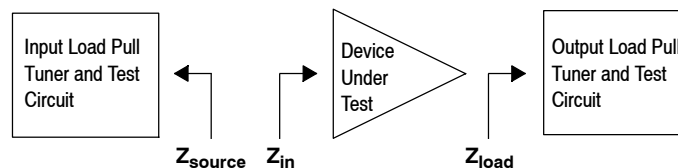
 Z_{load} = Measured impedance presented to the output of the device at the package reference plane.

P1dB - TYPICAL CARRIER SIDE LOAD PULL CONTOURS — 940 MHz

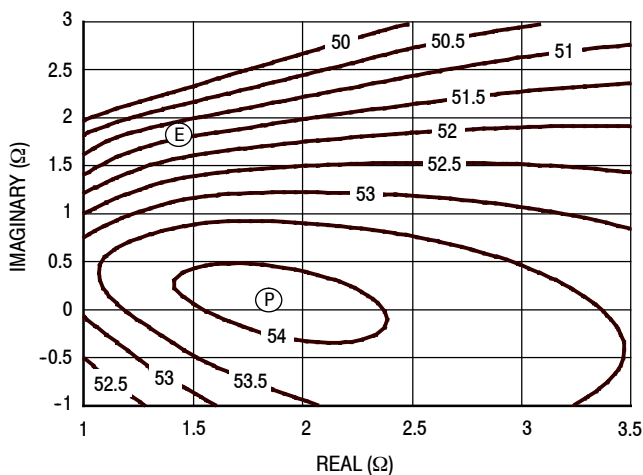

Figure 8. P1dB Load Pull Output Power Contours (dBm)

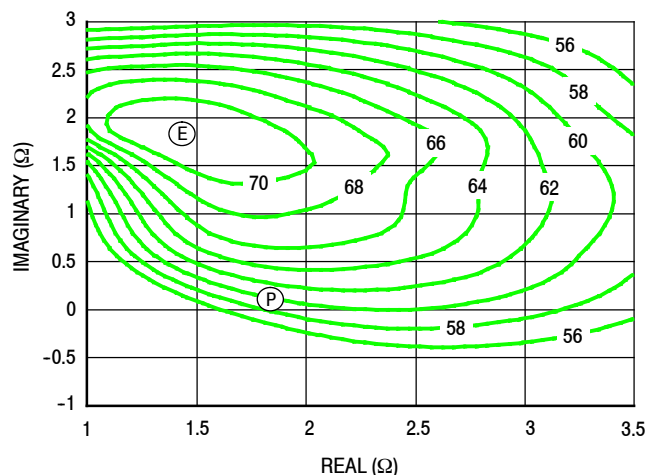

Figure 9. P1dB Load Pull Efficiency Contours (%)

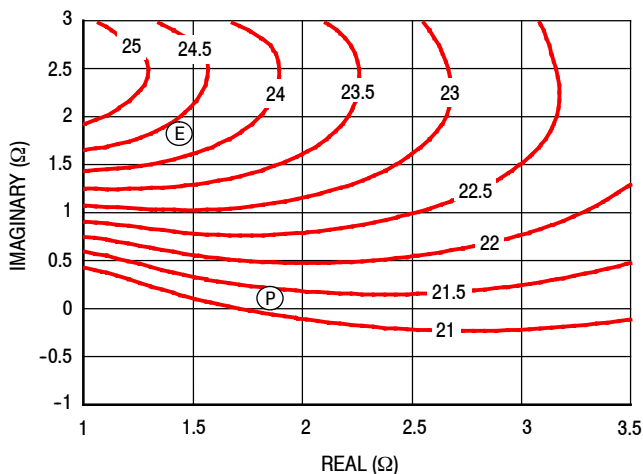

Figure 10. P1dB Load Pull Gain Contours (dB)

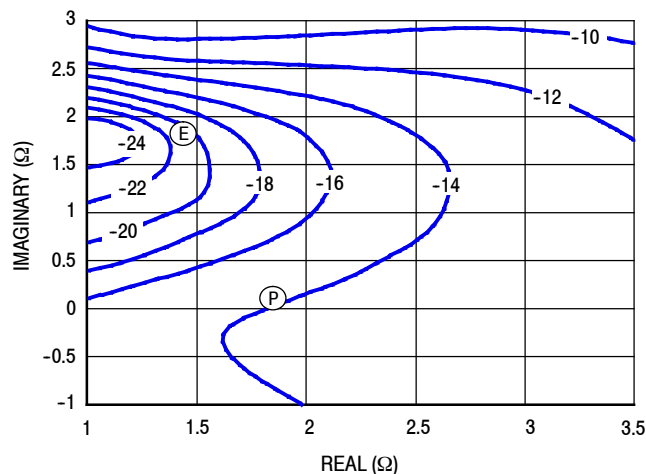

Figure 11. P1dB Load Pull AM/PM Contours (°)

NOTE: (P) = Maximum Output Power
 (E) = Maximum Drain Efficiency

- Gain
- Drain Efficiency
- Linearity
- Output Power

P3dB - TYPICAL CARRIER SIDE LOAD PULL CONTOURS — 940 MHz

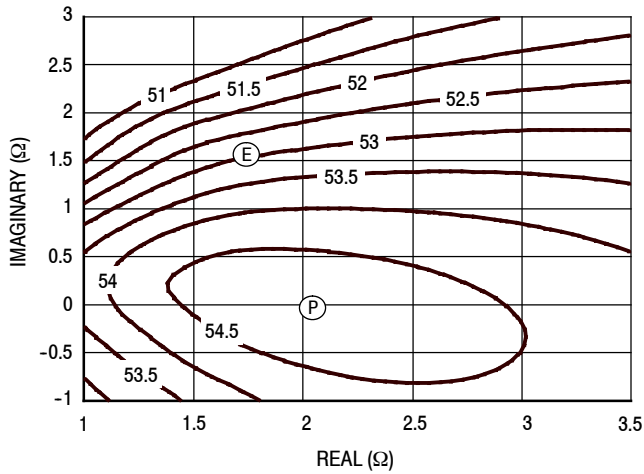

Figure 12. P3dB Load Pull Output Power Contours (dBm)

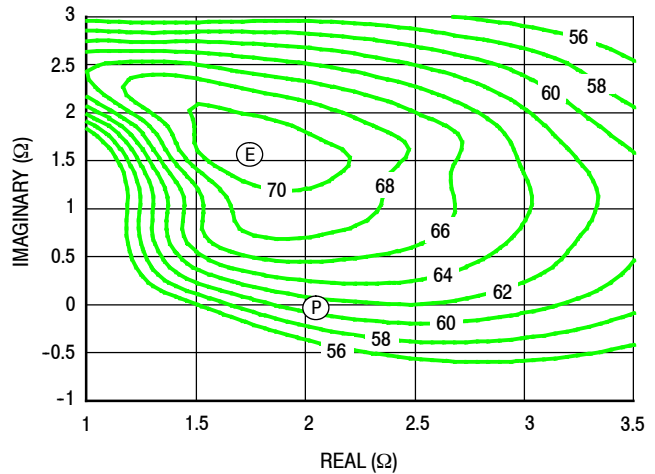

Figure 13. P3dB Load Pull Efficiency Contours (%)

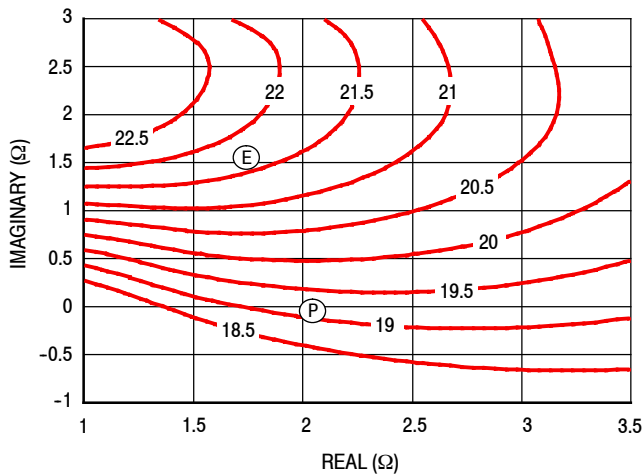

Figure 14. P3dB Load Pull Gain Contours (dB)

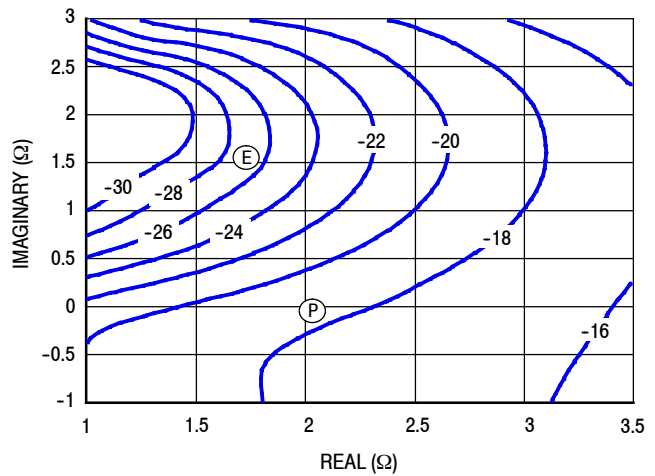

Figure 15. P3dB Load Pull AM/PM Contours (°)

NOTE: (P) = Maximum Output Power
 (E) = Maximum Drain Efficiency

- Gain
- Drain Efficiency
- Linearity
- Output Power

P1dB - TYPICAL PEAKING SIDE LOAD PULL CONTOURS — 940 MHz

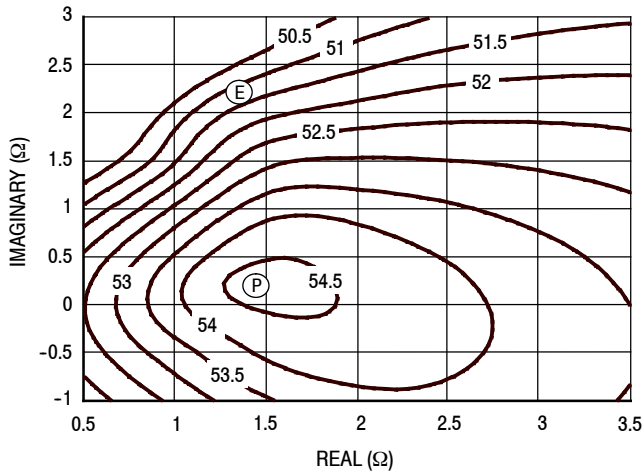

Figure 16. P1dB Load Pull Output Power Contours (dBm)

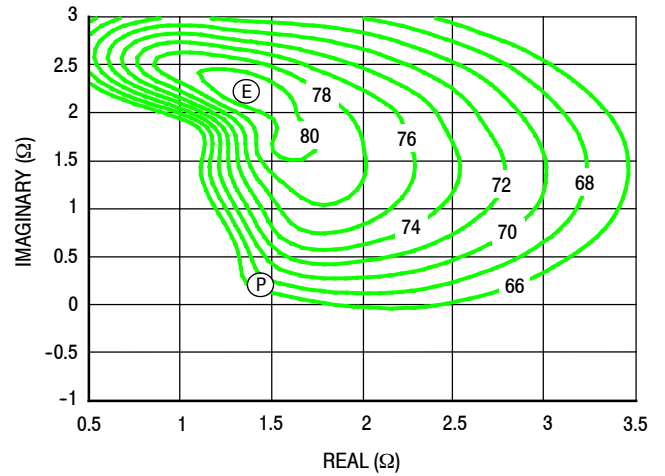

Figure 17. P1dB Load Pull Efficiency Contours (%)

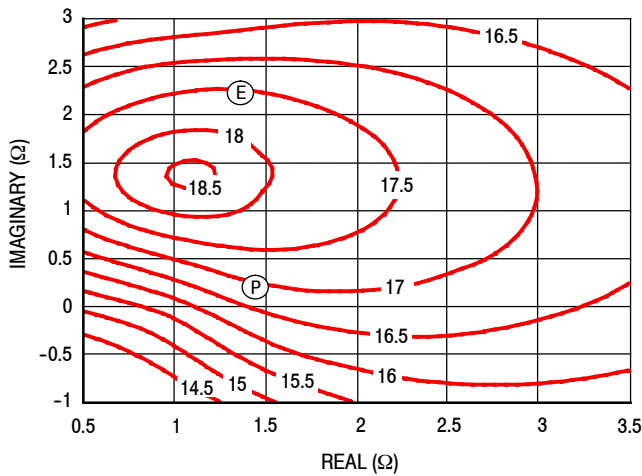

Figure 18. P1dB Load Pull Gain Contours (dB)

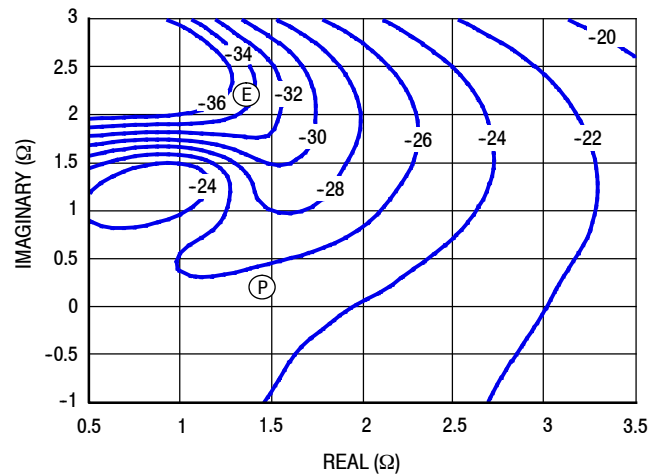

Figure 19. P1dB Load Pull AM/PM Contours (°)

NOTE: (P) = Maximum Output Power

(E) = Maximum Drain Efficiency

- Gain
- Drain Efficiency
- Linearity
- Output Power

P3dB - TYPICAL PEAKING SIDE LOAD PULL CONTOURS — 940 MHz

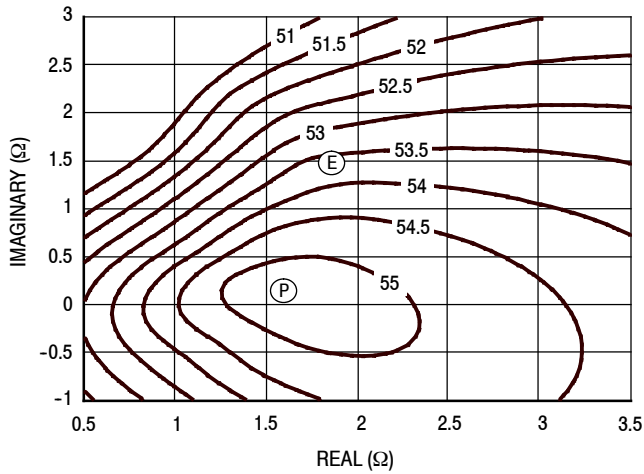

Figure 20. P3dB Load Pull Output Power Contours (dBm)

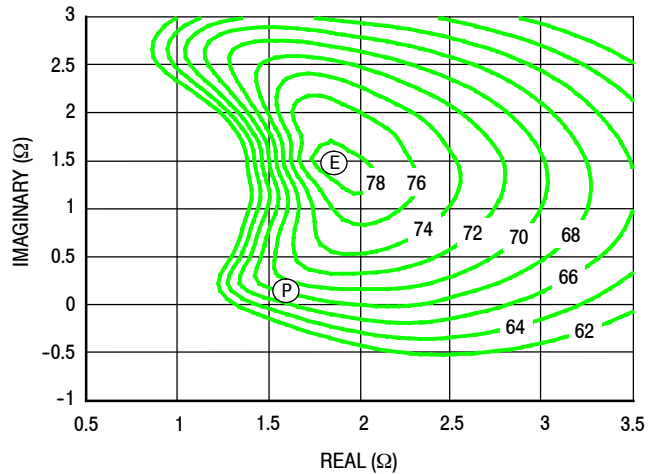

Figure 21. P3dB Load Pull Efficiency Contours (%)

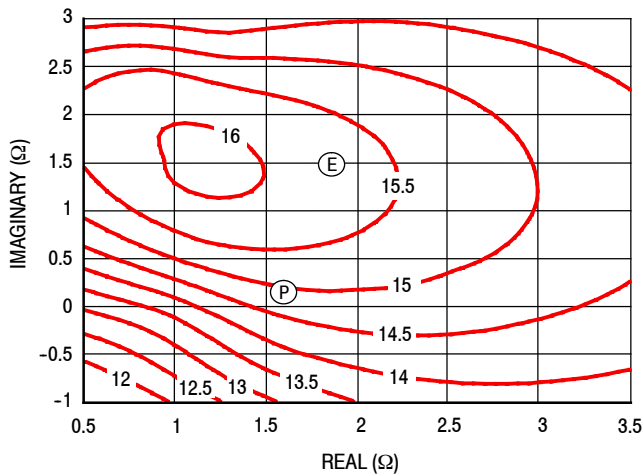

Figure 22. P3dB Load Pull Gain Contours (dB)

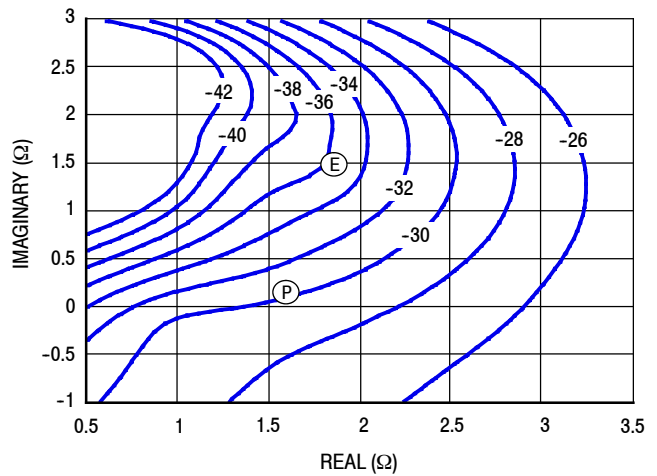
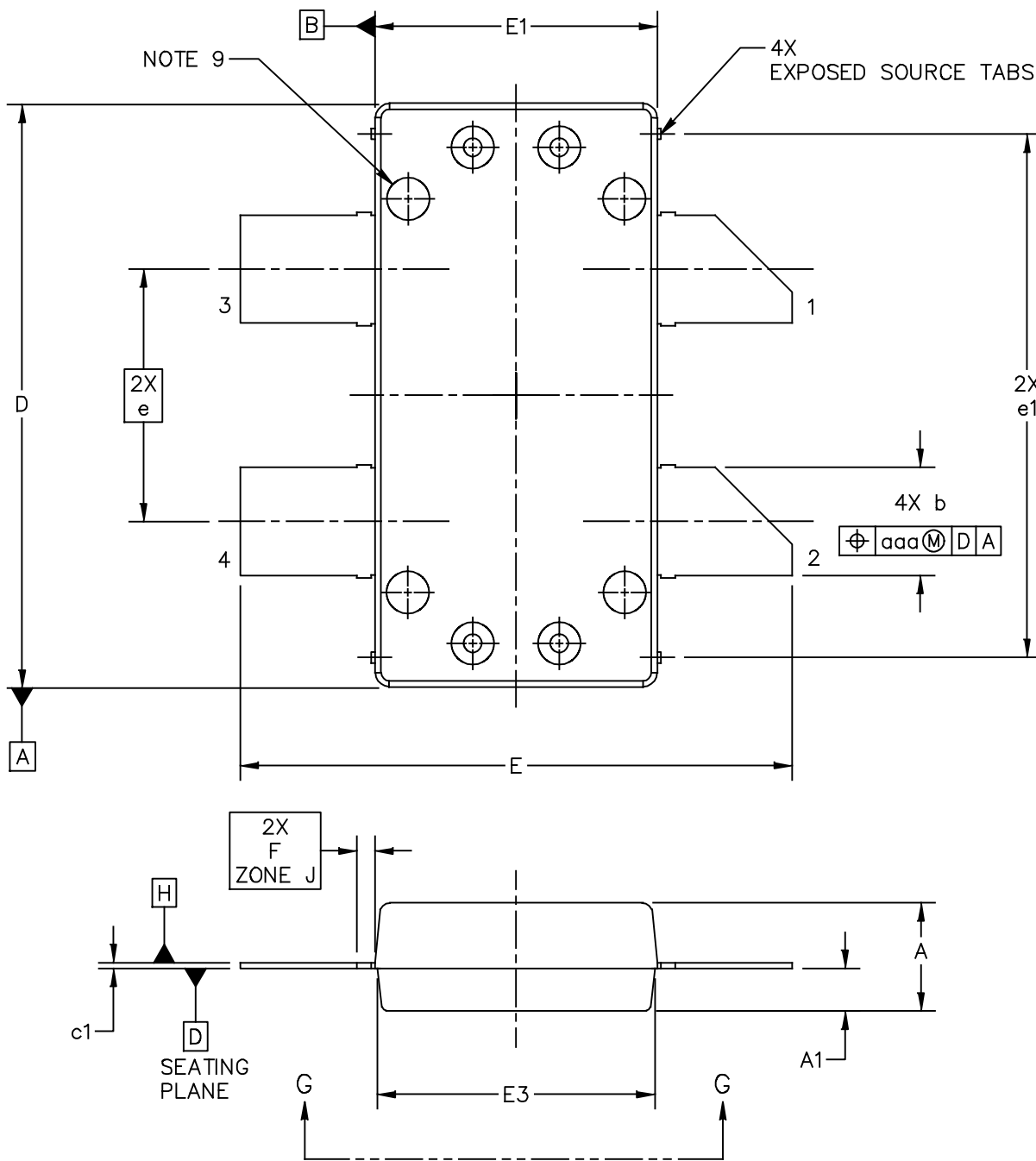

Figure 23. P3dB Load Pull AM/PM Contours (°)

NOTE: (P) = Maximum Output Power
 (E) = Maximum Drain Efficiency

- Gain
- Drain Efficiency
- Linearity
- Output Power

PACKAGE DIMENSIONS



© FREESCALE SEMICONDUCTOR, INC. ALL RIGHTS RESERVED.		MECHANICAL OUTLINE		PRINT VERSION NOT TO SCALE	
TITLE: OM780-4 STRAIGHT LEAD		DOCUMENT NO: 98ASA10833D		REV: A	
		CASE NUMBER: 2023-02		10 FEB 2010	
		STANDARD: NON-JEDEC			

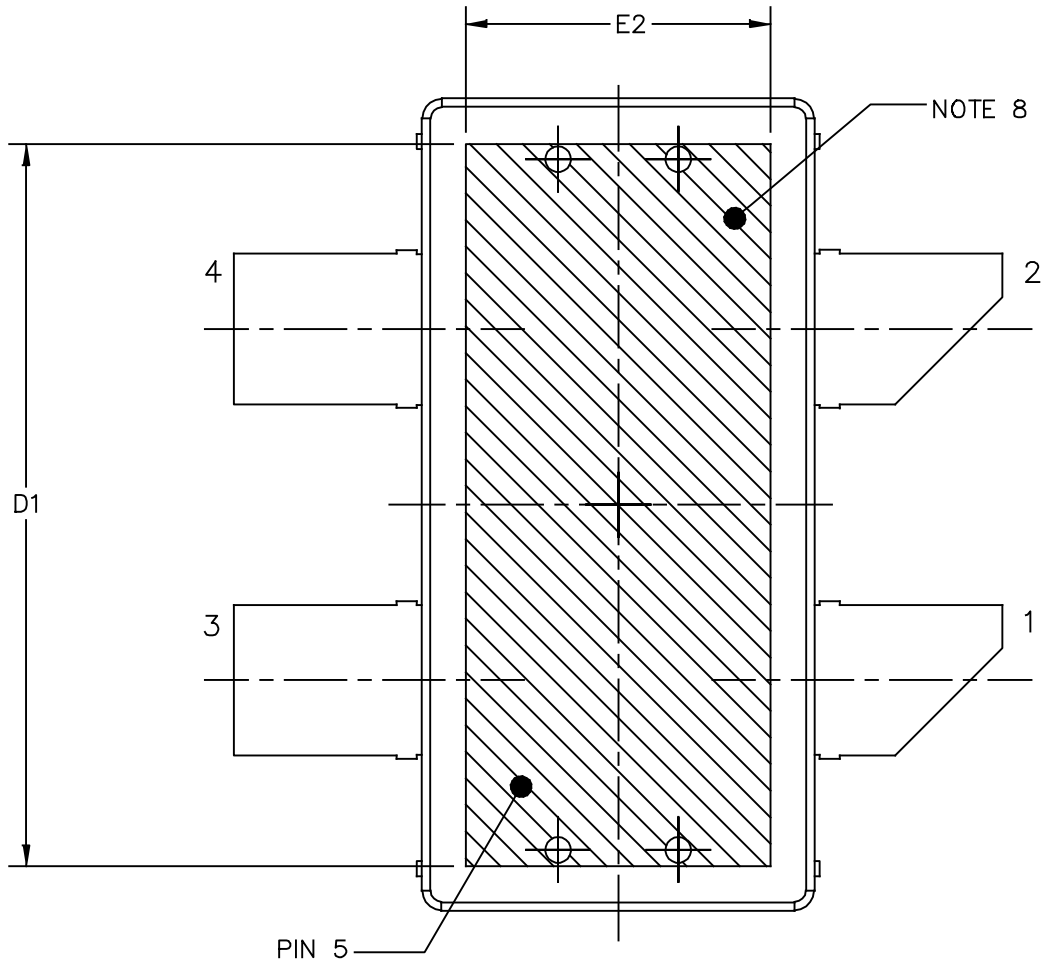

BOTTOM VIEW
VIEW G-G

© FREESCALE SEMICONDUCTOR, INC. ALL RIGHTS RESERVED.	MECHANICAL OUTLINE	PRINT VERSION NOT TO SCALE	
TITLE: OM780-4 STRAIGHT LEAD	DOCUMENT NO: 98ASA10833D	REV: A	
	CASE NUMBER: 2023-02	10 FEB 2010	
	STANDARD: NON-JEDEC		



NOTES:

1. CONTROLLING DIMENSION: INCH
2. INTERPRET DIMENSIONS AND TOLERANCES PER ASME Y14.5M-1994.
3. DATUM PLANE -H- IS LOCATED AT TOP OF LEAD AND IS COINCIDENT WITH THE LEAD WHERE THE LEAD EXITS THE PLASTIC BODY AT THE TOP OF THE PARTING LINE.
4. DIMENSIONS "D" AND "E1" DO NOT INCLUDE MOLD PROTRUSION. ALLOWABLE PROTRUSION IS .006 PER SIDE. DIMENSIONS "D AND "E1" DO INCLUDE MOLD MISMATCH AND ARE DETERMINED AT DATUM PLANE -H-.
5. DIMENSION b DOES NOT INCLUDE DAMBAR PROTRUSION. ALLOWABLE DAMBAR PROTRUSION SHALL BE .005 TOTAL IN EXCESS OF THE b DIMENSION AT MAXIMUM MATERIAL CONDITION.
6. DATUMS -A- AND -B- TO BE DETERMINED AT DATUM PLANE -H-.
7. DIMENSION A1 APPLIES WITHIN ZONE "J" ONLY.
8. HATCHING REPRESENTS THE EXPOSED AREA OF THE HEAT SLUG. THE DIMENSIONS D1 AND E2 REPRESENT THE VALUES BETWEEN THE TWO OPPOSITE POINTS ALONG THE EDGES OF EXPOSED AREA OF HEAT SLUG.
9. DIMPLED HOLE REPRESENTS INPUT SIDE.

DIM	INCH		MILLIMETER		DIM	INCH		MILLIMETER	
	MIN	MAX	MIN	MAX		MIN	MAX	MIN	MAX
A	0.148	.152	3.76	3.86	b	.147	.153	3.73	3.89
A1	.059	.065	1.50	1.65	c1	.007	.011	0.18	0.28
D	.808	.812	20.52	20.62	e	.350 BSC		8.89 BSC	
D1	.720	----	18.29	----	e1	.721	.729	18.31	18.52
E	.762	.770	19.36	19.56	aaa	.004		0.10	
E1	.390	.394	9.91	10.01					
E2	.306	----	7.77	----					
E3	.383	.387	9.72	9.83					
F	.025 BSC		0.635 BSC						

© FREESCALE SEMICONDUCTOR, INC. ALL RIGHTS RESERVED.		MECHANICAL OUTLINE	PRINT VERSION NOT TO SCALE
TITLE: OM780-4 STRAIGHT LEAD	DOCUMENT NO: 98ASA10833D		REV: A
	CASE NUMBER: 2023-02		10 FEB 2010
	STANDARD: NON-JEDEC		

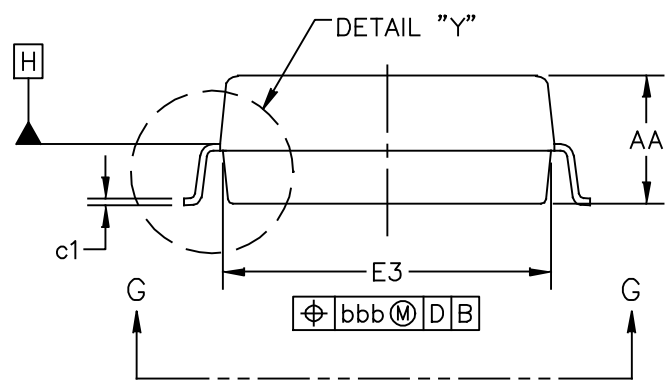
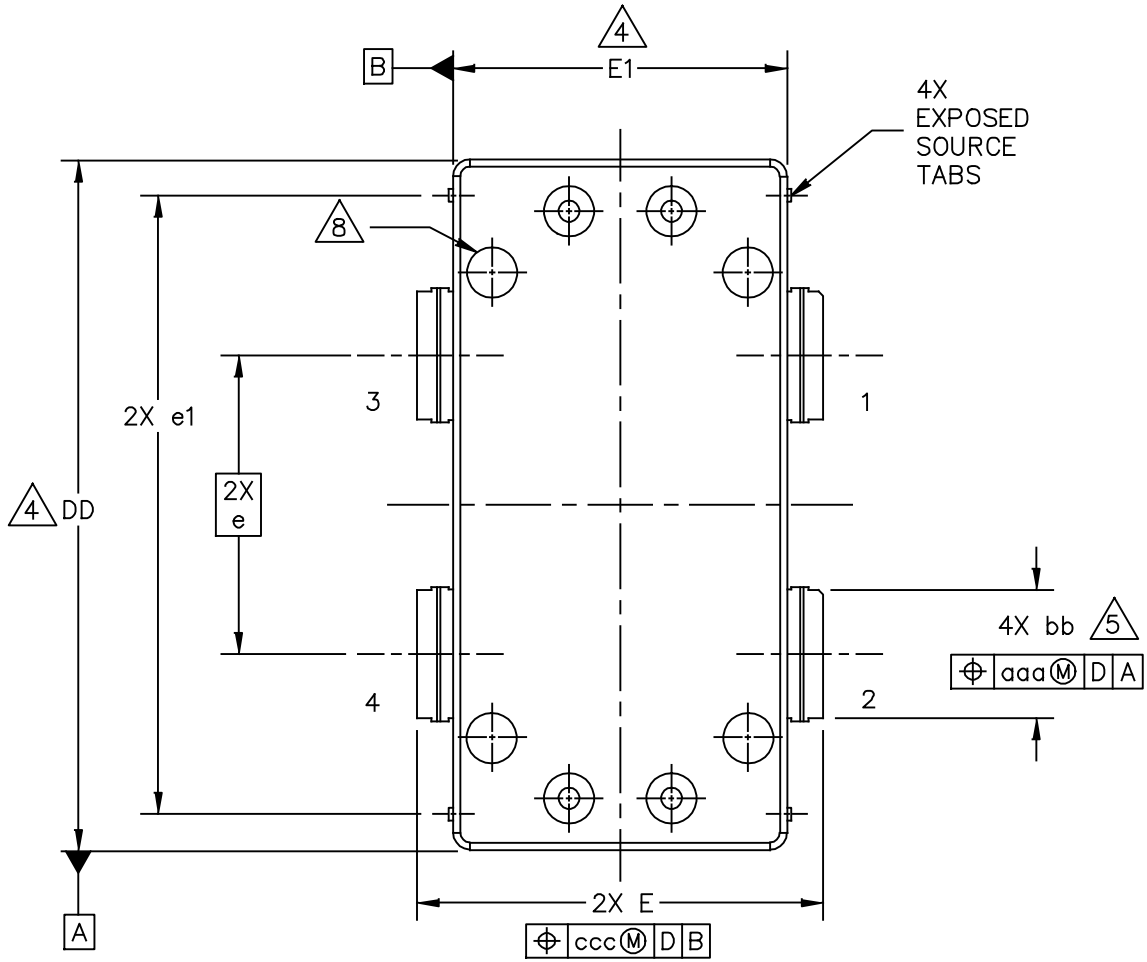

© FREESCALE SEMICONDUCTOR, INC. ALL RIGHTS RESERVED.	MECHANICAL OUTLINE	PRINT VERSION NOT TO SCALE
TITLE: OM-780G-4L	DOCUMENT NO: 98ASA10834D	REV: D
	STANDARD: NON-JEDEC	
		14 NOV 2013

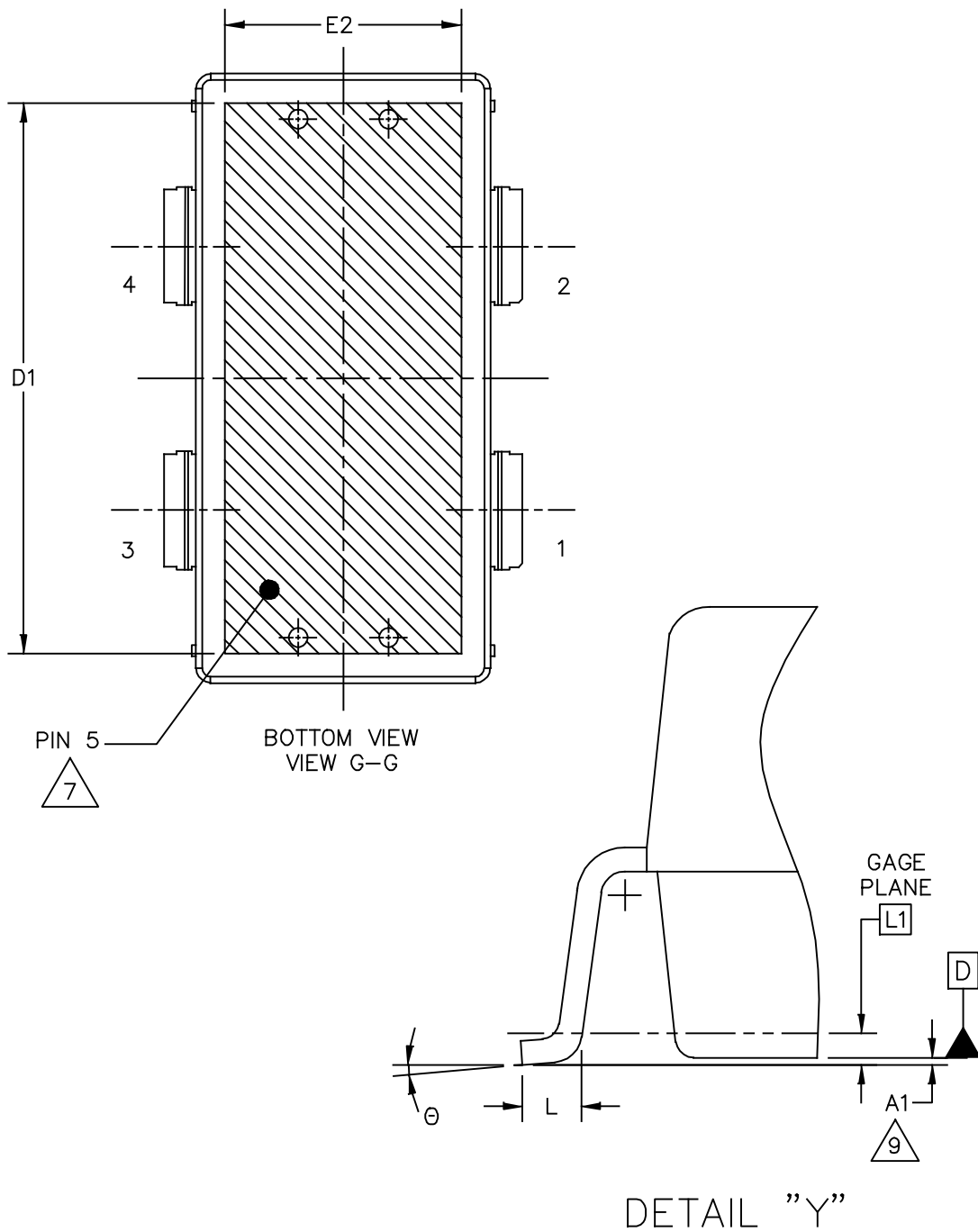

© FREESCALE SEMICONDUCTOR, INC. ALL RIGHTS RESERVED.	MECHANICAL OUTLINE	PRINT VERSION NOT TO SCALE
TITLE: OM-780G-4L	DOCUMENT NO: 98ASA10834D	REV: D
	STANDARD: NON-JEDEC	
	14 NOV 2013	

NOTES:

1. CONTROLLING DIMENSION: INCH

2. INTERPRET DIMENSIONS AND TOLERANCES PER ASME Y14.5M-1994.

3. DATUM PLANE H IS LOCATED AT TOP OF LEAD AND IS COINCIDENT WITH THE LEAD WHERE THE LEAD EXITS THE PLASTIC BODY AT THE TOP OF THE PARTING LINE.

4. DIMENSIONS DD AND E1 DO NOT INCLUDE MOLD PROTRUSION. ALLOWABLE PROTRUSION IS .006 INCH (0.15 MM) PER SIDE. DIMENSIONS DD AND E1 DO INCLUDE MOLD MISMATCH AND ARE DETERMINED AT DATUM PLANE H.

5. DIMENSION bb DOES NOT INCLUDE DAMBAR PROTRUSION. ALLOWABLE DAMBAR PROTRUSION SHALL BE .005 INCH (0.13 MM) TOTAL IN EXCESS OF THE bb DIMENSION AT MAXIMUM MATERIAL CONDITION.

6. DATUMS A AND B TO BE DETERMINED AT DATUM PLANE H.

7. HATCHING REPRESENTS THE EXPOSED AREA OF THE HEAT SLUG. THE DIMENSIONS D1 AND E2 REPRESENT THE VALUES BETWEEN THE TWO OPPOSITE POINTS ALONG THE EDGES OF EXPOSED AREA OF HEAT SLUG.

8. DIMPLED HOLE REPRESENTS INPUT SIDE.

9. DIMENSION A1 IS MEASURED WITH REFERENCE TO DATUM D. THE POSITIVE VALUE IMPLIES THAT THE BOTTOM OF PACKAGE IS HIGHER THAN THE BOTTOM OF THE LEAD.

DIM	INCH		MILLIMETER		DIM	INCH		MILLIMETER	
	MIN	MAX	MIN	MAX		MIN	MAX	MIN	MAX
AA	.148	.152	3.76	3.86	bb	.147	.153	3.73	3.89
A1	-.002	.002	-0.05	0.05	c1	.007	.011	0.18	0.28
DD	.808	.812	20.52	20.62	e	0.350 BSC		8.89 BSC	
D1	.720	----	18.29	----	e1	.721	.729	18.31	18.52
E	.470	.482	11.94	12.24	θ	0°	8°	0°	8°
E1	.390	.394	9.91	10.01	aaa	.004		0.10	
E2	.306	----	7.77	----	bbb	.006		0.15	
E3	.383	.387	9.73	9.83	ccc	.010		0.25	
L	.018	.024	0.46	0.61					
L1	.010 BSC		0.25 BSC						

© FREESCALE SEMICONDUCTOR, INC. ALL RIGHTS RESERVED.		MECHANICAL OUTLINE	PRINT VERSION NOT TO SCALE
TITLE: OM-780G-4L		DOCUMENT NO: 98ASA10834D	REV: D
		STANDARD: NON-JEDEC	
		14 NOV 2013	

PRODUCT DOCUMENTATION, SOFTWARE AND TOOLS

Refer to the following documents, software and tools to aid your design process.

Application Notes

- AN1955: Thermal Measurement Methodology of RF Power Amplifiers

Engineering Bulletins

- EB212: Using Data Sheet Impedances for RF LDMOS Devices

Software

- Electromigration MTTF Calculator
- RF High Power Model
- .s2p File

Development Tools

- Printed Circuit Boards

For Software and Tools, do a Part Number search at <http://www.freescale.com>, and select the “Part Number” link. Go to the Software & Tools tab on the part’s Product Summary page to download the respective tool.

REVISION HISTORY

The following table summarizes revisions to this document.

Revision	Date	Description
0	Jan. 2014	• Initial Release of Data Sheet

How to Reach Us:

Home Page:
freescale.com

Web Support:
freescale.com/support

Information in this document is provided solely to enable system and software implementers to use Freescale products. There are no express or implied copyright licenses granted hereunder to design or fabricate any integrated circuits based on the information in this document.

Freescale reserves the right to make changes without further notice to any products herein. Freescale makes no warranty, representation, or guarantee regarding the suitability of its products for any particular purpose, nor does Freescale assume any liability arising out of the application or use of any product or circuit, and specifically disclaims any and all liability, including without limitation consequential or incidental damages. "Typical" parameters that may be provided in Freescale data sheets and/or specifications can and do vary in different applications, and actual performance may vary over time. All operating parameters, including "typicals," must be validated for each customer application by customer's technical experts. Freescale does not convey any license under its patent rights nor the rights of others. Freescale sells products pursuant to standard terms and conditions of sale, which can be found at the following address: freescale.com/SalesTermsandConditions.

Freescale and the Freescale logo are trademarks of Freescale Semiconductor, Inc., Reg. U.S. Pat. & Tm. Off. Airfast is a trademark of Freescale Semiconductor, Inc. All other product or service names are the property of their respective owners.

© 2014 Freescale Semiconductor, Inc.