



## Telecom Performance 5x7mm TCXO / VCTCXO T / TV Series

# CONNOR WINFIELD



2111 Comprehensive Drive

Aurora, Illinois 60505

Phone: 630-851-4722

Fax: 630-851-5040

www.conwin.com

US Headquarters:

630-851-4722

European Headquarters:

+353-61-472221

### Description:

Connor-Winfield's Txxx and TVxxx series are 5x7mm TCXO and VCTCXO products with exceptional frequency stability and low phase noise. Through the use of analog temperature compensation, these products are capable of holding Stratum 3 level temperature stabilities of  $\pm 0.28$  ppm over the commercial and industrial temperature ranges. Available in 4-pad or 10-pad surface mount footprints.

These products are designed for such applications as IEEE 1588 PTP and Synchronous Ethernet.

All models will meet  $\pm 4.6$  ppm accuracies for twenty years

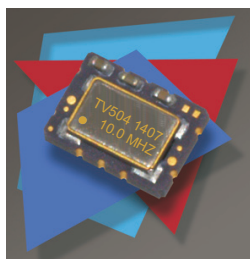

### Features:

- Frequency Stabilities Available:
  - +/-0.28 ppm (6.4 to 49.152 MHz) ✓ STRATUM 3
  - +/-0.50 ppm (6.4 to 49.152 MHz)
  - +/-1.00 ppm or +/-2.00 ppm (6.4 to 54 MHz)
- Temperature Ranges Available:
  - 0 to 85°C, 0 to 70°C, -40 to 85°C or -20 to 70°C
- Packages Available:
  - T - Series: 5 x 7mm - 10 Pad
  - TV - Series: 5 x 7mm - 4 Pad
- 3.3 Vdc Operation
- Output Logic: LVCMOS or Clipped Sinewave
- Fixed Frequency - TCXO
- Voltage Controlled - VCTCXO
- Low Jitter <0.50 ps RMS
- Low Phase Noise
- Tri-State Enable/Disable: (T Model Series Only)
- Tape and Reel Packaging
- RoHS Compliant / Lead Free ✓ RoHS

### Applications:

- IEEE 1588 Applications
- Synchronous Ethernet slave clocks, ITU-T G.8262 EEC options 1 & 2
- Compliant to Stratum 3, GR-1244-CORE & GR-253-CORE
- Wireless Communications
- Small Cells
- Test and Measurement
- GPS

### Standard Frequencies Available \*

\* 6.4, 9.72, 10, 10.24, 12.5, 12.8, 13.5, 19.2, 19.44, 20, 20.48, 25, 27, 38.88, 40 MHz

Available frequencies from the factory for small quantity orders or quick delivery.

Additional frequencies are available. Alternate package outline for select part numbers 38MHz to 52MHz

\*\* Not all

Models  
available at  
Digi-Key

### Ordering Information

TV	5	0	4	- 010.0M
Type / Package TCXO / VCTCXO Series  T = 5.0x7.0 mm 10 Pads TV = 5.0x7.0 mm 4 Pads	Temperature Range  3 = 0 to 85°C 5 = 0 to 70°C 6 = -40 to 85°C 7 = -20 to 70°C	Frequency Stability  0 = $\pm 0.28$ ppm 1 = $\pm 0.50$ ppm 2 = $\pm 1.00$ ppm 3 = $\pm 2.00$ ppm	Features  2 = TCXO, LVCMOS, 3.3 Vdc 3 = TCXO, Clipped Sinewave, 3.3 Vdc 4 = VCTCXO, LVCMOS, 3.3 Vdc 5 = VCTCXO, Clipped Sinewave, 3.3 Vdc	Output Frequency  Frequency Format -xxx.xM Min -xxx.xxxxxM Max *Amount of numbers after the decimal point. M = MHz

Example: Part Number

TV504-010.0M = 5x7mm 4 pad package,  $\pm 0.28$  ppm, 0 to 70°C, 3.3 Vdc, LVCMOS Output, VCTCXO  
T715-012.8M = 5x7mm 10 pad package,  $\pm 0.50$  ppm, -20 to 70°C, 3.3 Vdc, Clipped Sinewave Output, VCTCXO  
T522-050.0M = 5x7mm 10 pad package,  $\pm 1.00$  ppm, 0 to 70°C, 3.3 Vdc, LVCMOS Output, TCXO  
TV602-010.0M = 5x7mm 4 pad package,  $\pm 0.28$  ppm, -40 to 85°C, 3.3 Vdc, LVCMOS Output, TCXO

Bulletin **Tx176**Page **1 of 6**Revision **20**Date **27 July 2016**



## Absolute Maximum Ratings

Parameter	Minimum	Nominal	Maximum	Units	Notes
Storage Temperature	-55	-	95	°C	
Supply Voltage (Vcc)	-0.5	-	6.0	Vdc	
Input Voltage	-0.5	-	Vcc + 0.5	Vdc	

## Operating Specifications

Parameter	Minimum	Nominal	Maximum	Units	Notes
Output Frequency (Fo)					
Models Tx0x, TVx0x	6.4	-	49.152	MHz	
Models Tx1x, TVx1x	6.4	-	49.152	MHz	
Models Tx2x, TVx2x	6.4	-	54	MHz	
Models Tx3x, TVx3x	6.4	-	54	MHz	
Operating Temperature Range	(See Ordering Information for full part number)				
Models T3xx, TV3xx	0	-	85	°C	
Models T5xx, TV5xx	0	-	70	°C	
Models T6xx, TV6xx	-40	-	85	°C	
Models T7xx, TV7xx	-20	-	70	°C	
Frequency Calibration @ 25 °C	-1.0	-	1.0	ppm	1
Frequency Stability (See Ordering Information for full part number) Per STRATUM 3 GR-1244-CORE					
<b>Frequency Stability ±0.28 ppm is only available in the frequency range of 6.4 to 50 MHz.</b>					
Models Tx0x, TVx0x	-0.28	-	0.28	ppm	2
Holdover Stability	-0.32	-	0.32	ppm	3
Constant Temperature Stability	-40	-	40	ppb	Over 24 Hrs.
Frequency Stability (See Ordering Information for full part number)					
Models Tx1x, TVx1x	-0.50	-	0.50	ppm	2
Models Tx2x, TVx2x	-1.00	-	1.00	ppm	2
Models Tx3x, TVx3x	-2.00	-	2.00	ppm	2
Frequency vs. Load Stability	-0.05	-	0.05	ppm	±5%
Frequency vs. Voltage Stability	-0.05	-	0.05	ppm	±5%
Static Temperature Hysteresis	-	-	0.40	ppm	4
Freq. shift after reflow soldering	-1.0	-	1.0	ppm	5
Long Term Stability	-1.0	-	1.0	ppm	6
Aging					
per Life (20 Years)	-3.0	-	3.0	ppm	
per Day	-40	-	40	ppb	
Total Frequency Tolerance	-4.6	-	4.6	ppm	7
Supply Voltage (Vcc)	3.135	3.30	3.465	Vdc	
Supply Current (Icc) LVCMOS	-	2.1	6.0	mA	
Clipped Sinewave	-	1.3	2.9	mA	
Jitter:					
Period Jitter	-	3.0	5.0	ps RMS	
Integrated Phase Jitter (12K to Fo/2)	-	0.3	1.0	ps RMS	8
Allan Deviation (1s)	-	1.0E-10	-		
Typical SSB Phase Noise					
For Fo	10.0 MHz	25.0 MHz	50.0 MHz		
@ 10 Hz offset	-98	-90	-73	dBc/Hz	
@ 100 Hz offset	-125	-120	-103	dBc/Hz	
@ 1 KHz offset	-143	-140	-134	dBc/Hz	
@ 10 KHz offset	-151	-151	-151	dBc/Hz	
@ 100 KHz offset	-152	-152	-152	dBc/Hz	
@ 1 MHz offset	-155	-154	-154	dBc/Hz	
Start-Up Time	-	-	10	ms	



### Control Voltage Input Characteristics

Parameter	Minimum	Nominal	Maximum	Units	Notes
Control Voltage	0.3	1.65	3.0	V	
Frequency Pullability	±10	±12	-	ppm	
Pull Slope (Vc=1.65V)	-	8.00	-	ppm/V	
Control Voltage Slope	Positive Slope				
Monotonic Linearity	-	-	5	%	
Input Impedance	100K	-	-	Ohm	
Modulation Bandwidth (3dB)	10	-	-		KHz

### OE Enable /Disable Input Characteristics (Pad 8) T Series only

Parameter	Minimum	Nominal	Maximum	Units	Notes
Enable Input Voltage -(Vih)	70%Vcc	-	-	Vdc	9
Disable Input Voltage - (Vil)	-	-	30%Vcc	Vdc	9

Function	Output
Low:	Disabled (High Impedance)
High or Open:	Enabled

### LVC MOS Output Characteristics

Parameter	Minimum	Nominal	Maximum	Units	Notes
Load (CL)	-	15	-	pF	10
Voltage (High) (Voh)	90%Vcc	-	-	Vdc	
(Low) (Vol)	-	-	10%Vcc	Vdc	
Current (High) (Ioh)	-4	-	-	mA	
(Low) (Iol)	-	-	4	mA	
Duty Cycle at 50% of Vcc	45	50	55	%	
Rise / Fall Time 10% to 90%	-	4	8	ns	

### Clipped Sinewave Output Characteristics

Parameter	Minimum	Nominal	Maximum	Units	Notes
Load (RC)					11
Output Load Resistance	-	10K	-	Ohm	12
Output Load Capacitance	-	10	-	pF	
Output Voltage (< 40 MHz)	1.0	1.2	-	V	pk-pk
Output Voltage (=>40 MHz)	0.8	1.0	-	V	pk-pk
Output Impedance	-	200	-	Ohms	

### Package Characteristics

Package	Hermetically sealed ceramic package with grounded metal cover
---------	---

### Environmental Characteristics

Vibration:	Vibration per Mil Std 883E Method 2007.3 Test Condition A.
Shock:	Mechanical Shock per Mil Std 883E Method 2002.4 Test Condition B.
Soldering Process:	RoHS compliant lead free. See soldering profile on page 6.

### Notes:

- Initial calibration @ 25°C. ±2°C, for VCTCXO's Vc = 1.65V. Specifications at time of shipment
- Frequency stability vs. change in temperature.  $[\pm(F_{max}-F_{min})/(2 \cdot F_0)]$ . For VCTCXO's - Vc = 1.65V
- Inclusive of frequency stability, supply voltage change (±1%), aging, for 24 hours. Per STRATUM 3 GR-1244-CORE.
- Frequency change after reciprocal temperature ramped over the operating range. Frequency measured before and after at 25°C
- Two consecutive solder reflows after 1 hour recovery @ 25°C.
- Frequency drift over 1 year @ 25°C.
- Inclusive of calibration @ 25°C, frequency vs. change in temperature, change in supply voltage (±5%), load change (±5%), reflow soldering process and 20 years aging.
- BW = 12 KHz to 20 MHz
- Leave Pad 8 on the T Series unconnected if enable / disable function is not required. When tri-stated, the output stage is disabled but the oscillator and compensation circuit are still active (current consumption < 1 mA).
- Attention: To achieve optimal frequency stability, and in some cases to meet the specification stated on this data sheet, it is required that the circuit connected to this TCXO output must have the equivalent input capacitance that is specified by the nominal load capacitance. Deviations from the nominal load capacitance will have a graduated effect on the stability of approximately 20 ppb per pF load difference.
- Load components are required for proper operation of the device.
- Output is AC coupled.

Bulletin	<b>Tx176</b>
Page	<b>3 of 6</b>
Revision	<b>20</b>
Date	<b>27 July 2016</b>



## T Series Package Outline

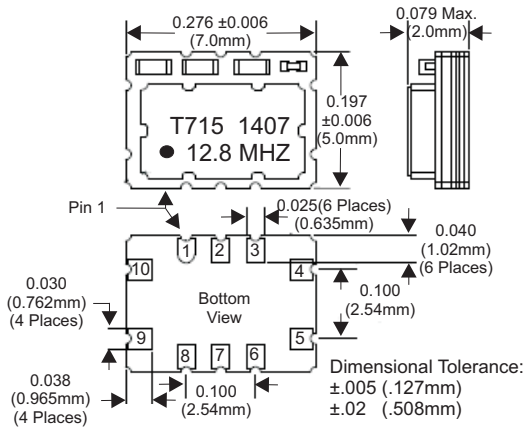

## T Series Suggested Pad Layout

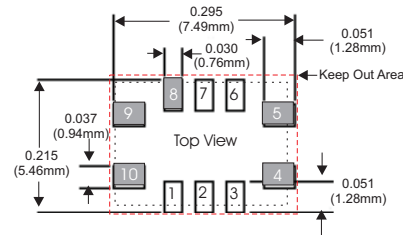

## T Series Pad Connections

- 1: Do Not Connect
- 2: Do Not Connect
- 3: Do Not Connect
- 4: Ground
- 5: Output
- 6: Do Not Connect
- 7: Do Not Connect
- 8: Enable / Disable (OE)
- 9: Supply Voltage (Vcc)
- 10: VCTCXO: Control Voltage (Vc)  
TCXO: N/C

\* Do not route any traces in the keep out area. It is recommended the next layer under the keep out area is to be ground plane.

## T Series Alternate Package Outline

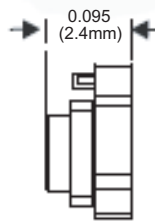
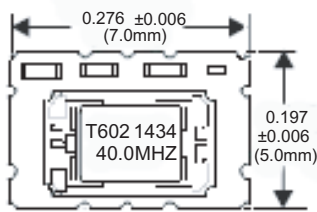

Alternate package applies to select part numbers in the 38 to 52MHz frequency range. The differences are the top view crystal size, and the overall height. Bottom view, suggested pad layout, and pad connections all remain the same as above.

## TV Series Package Outline

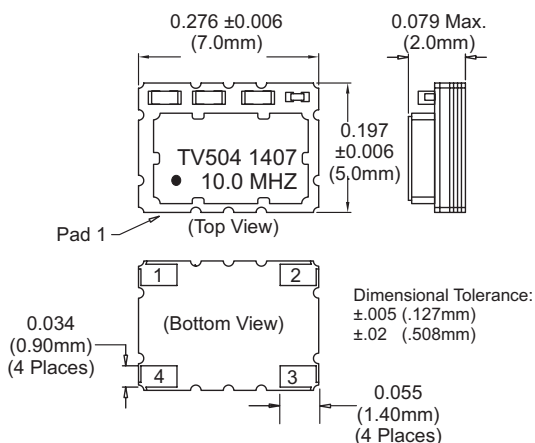

## TV Series Suggested Pad Layout

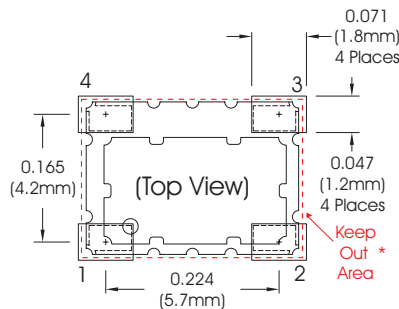

## TV Series Pad Connections

- 1: VCTCXO: Voltage Control (Vc)  
TCXO: N/C
- 2: Ground
- 3: Output
- 4: Supply (Vcc)

\* Do not route any traces in the keep out area. It is recommended the next layer under the keep out area is to be ground plane.

Bulletin	<b>Tx176</b>
Page	<b>4 of 6</b>
Revision	<b>20</b>
Date	<b>27 July 2016</b>

## T Series Design Recommendations

## TV Series Design Recommendations

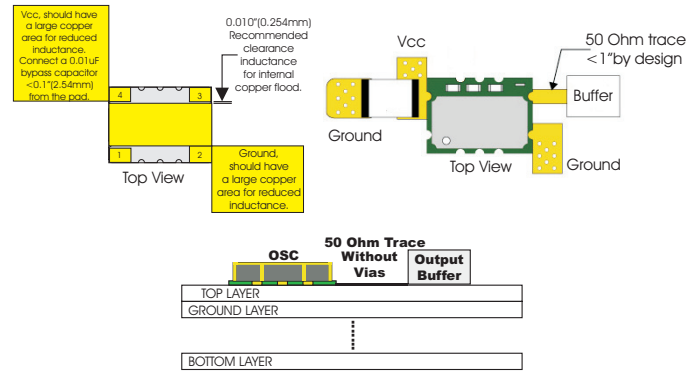
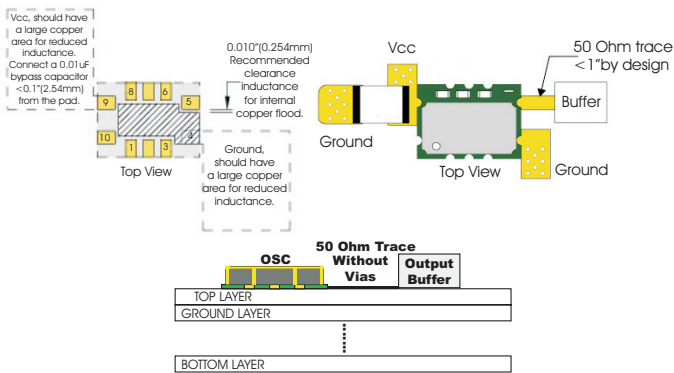

## T Series LVC MOS Test Circuit

## TV Series LVC MOS Test Circuit

## LVC MOS Output Waveform

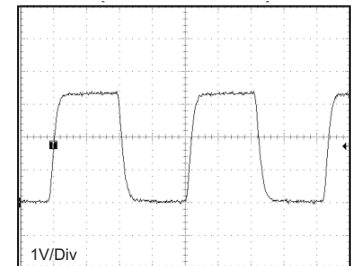
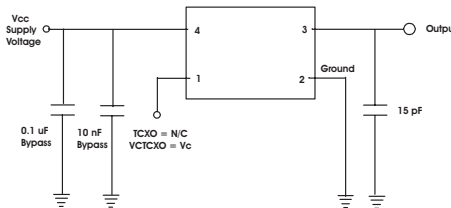
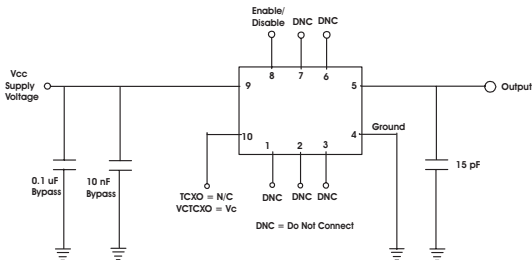

## T Series Clipped Sinewave Test Circuit

## TV Series Clipped Sinewave Test Circuit

## Clipped Sinewave Output Waveform

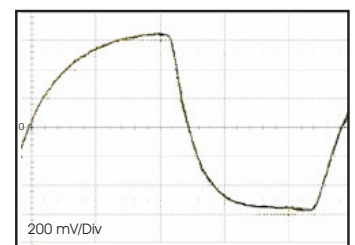
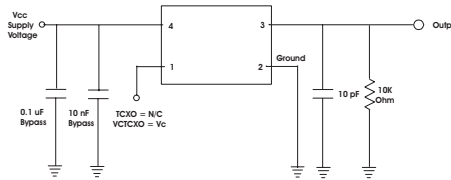
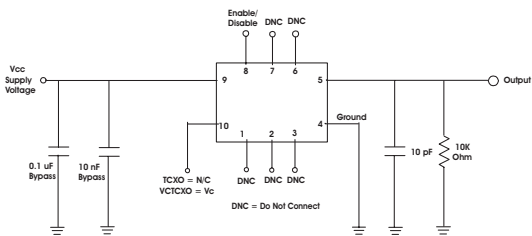

Note: The clipped sinewave output is AC coupled

Bulletin	Tx176
Page	5 of 6
Revision	20
Date	27 July 2016



## Phase Noise Information

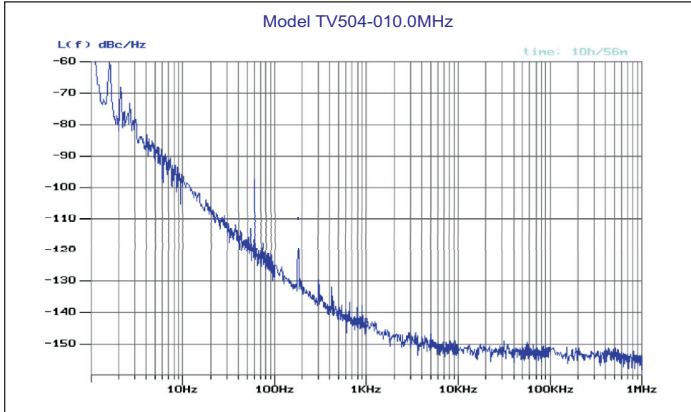

## TIE

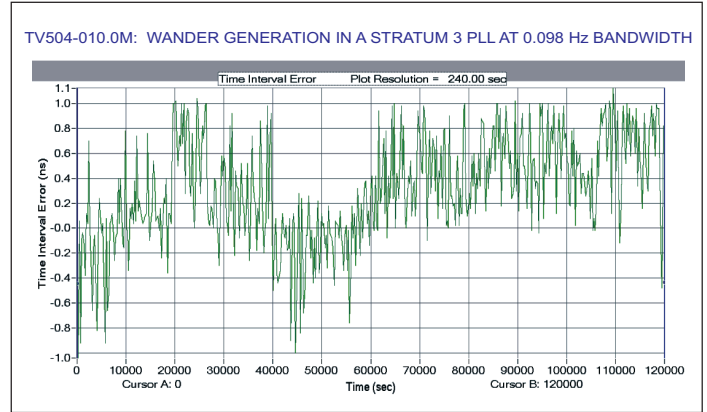

## MTIE

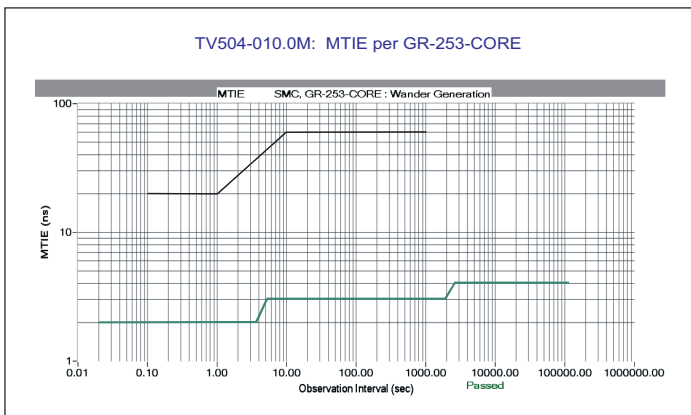

## TDEV

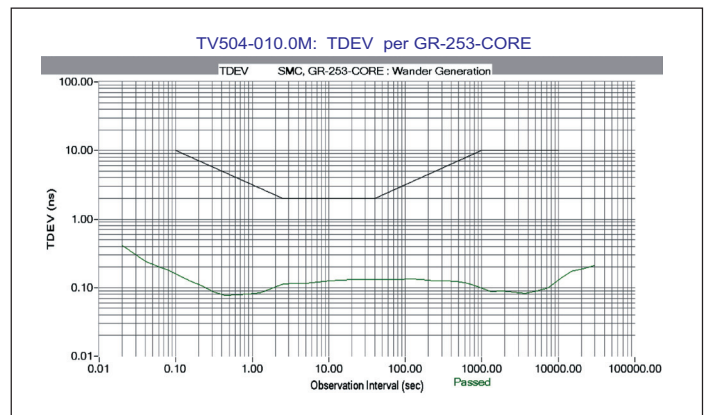

## 5x7mm Tape and Reel Information

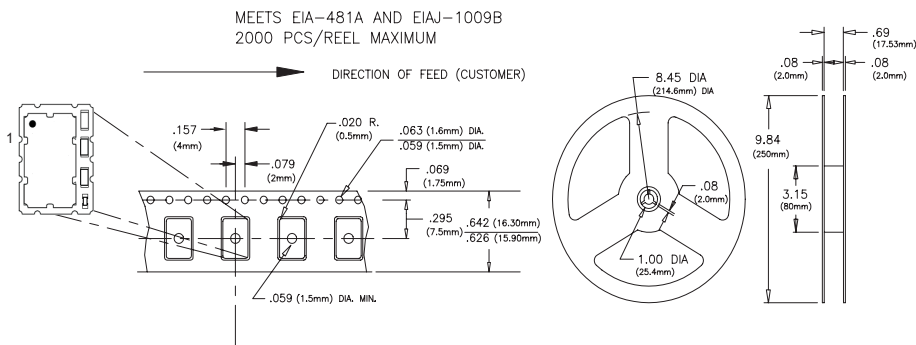

## Solder Profile

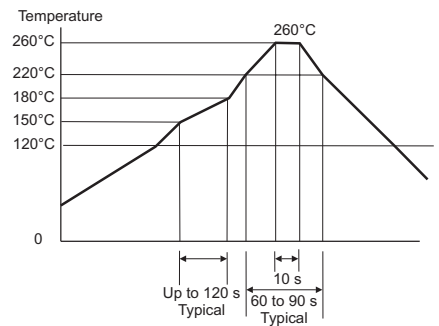

Meets IPC/JEDEC J-STD-020C

## Revision History

Revision	Date	Action
17	02/11/14	Updated specifications and combined the T and TV series data sheets.
18	09/15/14	Added Alternate Package Outline
19	04/01/15	Updated Frequency Stabilities
20	07/27/16	Added a Standard Frequency

Bulletin	<b>Tx176</b>
Page	<b>6 of 6</b>
Revision	<b>20</b>
Date	<b>27 July 2016</b>