

# Multilayer Piezoelectric Actuators

Multilayer Piezoelectric Actuators



- All specifications in this catalog and production status of products are subject to change without notice. Prior to the purchase, please contact NEC TOKIN for updated product data.
- Please request for a specification sheet for detailed product data prior to the purchase.
- Before using the product in this catalog, please read "Precautions" and other safety precautions listed in the printed version catalog.

**PRECAUTIONS TO BE TAKEN WHEN USING MULTILAYER  
PIEZOELECTRIC ACTUATORS**  
**(Please read these precautions before using our products)**

1. Before using our products or designing a system using our products, read the precautions and specifications (such as level of quality) for the products you intend to use on the last page of this manual.

2. The main failures with multilayer piezoelectric actuators are deterioration of insulation resistance, short-circuit, and open-circuit.

Before using the products, design systems carefully to ensure redundancy, prevention of the spread of fire, and prevention of faulty operation allowing for the occurrence of failures.

3. Use the products after checking the working conditions and rated performance of each of the multilayer piezoelectric actuator series.

Selection of AE series (a resin-coated type) or ASB, ASL and AHB series (a metal-sealed type) should be based on the intended working temperature and humidity.



- All specifications in this catalog and production status of products are subject to change without notice. Prior to the purchase, please contact NEC TOKIN for updated product data.
- Please request for a specification sheet for detailed product data prior to the purchase.
- Before using the product in this catalog, please read "Precautions" and other safety precautions listed in the printed version catalog.

## CONTENTS

<b>Resin coated type multilayer piezoelectric actuators AE series .....</b>	<b>5</b>
<b>Metal sealed type multilayer piezoelectric actuators .....</b>	<b>11</b>
<b>ASB series (85°C rated), ASL series (150°C rated), AHB series (High displacement model)</b>	
<b>Reliability .....</b>	<b>19</b>
<b>Guide to use .....</b>	<b>21</b>
<b>Precautions .....</b>	<b>23</b>



- All specifications in this catalog and production status of products are subject to change without notice. Prior to the purchase, please contact NEC TOKIN for updated product data.
- Please request for a specification sheet for detailed product data prior to the purchase.
- Before using the product in this catalog, please read "Precautions" and other safety precautions listed in the printed version catalog.

NEC TOKIN's multilayer piezoelectric actuators are available in four series.

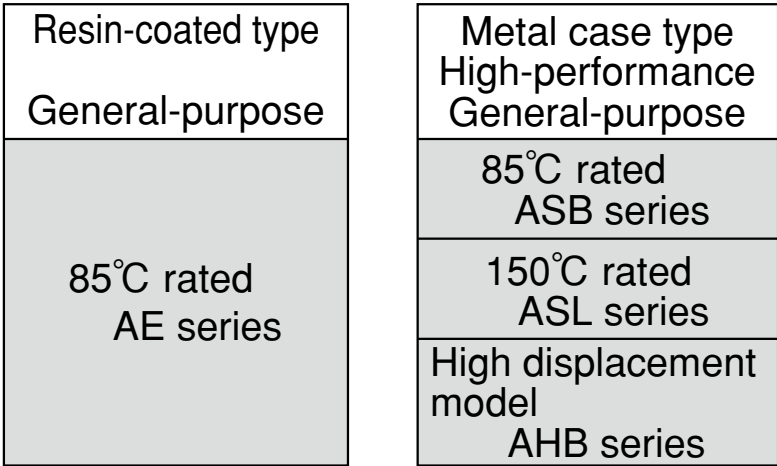

\*AE series is resin-coated products. Therefore we recommend using metal case type, ASB, ASL and AHB series in high humidity condition.

NEC TOKIN's multilayer piezoelectric actuators are designed using unique element structure technology and using ceramic materials with high electrostrictive factors developed by NEC TOKIN.

\*For detail information of piezoelectric ceramic material, please refer to a catalogue of "Piezoelectric ceramics".

**Features**

- Special ceramics developed by NEC TOKIN are used in piezoelectric ceramic elements.
- As compared with conventional actuator elements, NEC TOKIN's multilayer piezoelectric actuators have advantages as follows.

- Advantages over electromagnetic actuators**
  - Faster response
  - High resolution for positioning
  - Large generated force
  - Low power consumption
  - No electromagnetic noise
- Advantages over bimorph piezoelectric actuators**
  - High energy conversion efficiency (around 7 times the energy conversion efficiency of the bimorph type actuator), and low power consumption
  - Large generated force
  - Stable displacement, and reduced shift and creep phenomena
  - Response speed (more than 100 times the response speed of the bimorph piezoelectric actuator)
- Advantages over stacked piezoelectric actuators**
  - Compact size (less than 1/10 the specific volume of the stacked piezoelectric actuator)
  - Low drive voltage, and ease of use
  - Inexpensive

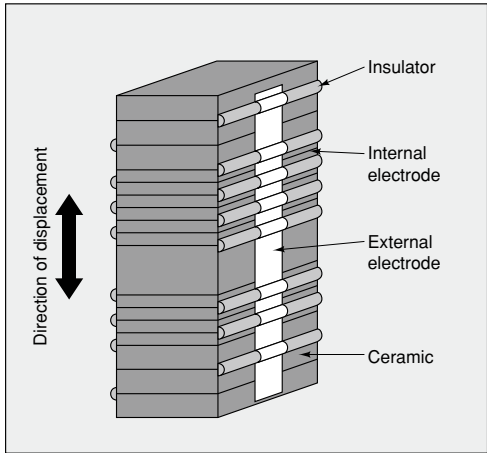

Structure of NEC TOKIN's Multilayer Piezoelectric Actuator



● All specifications in this catalog and production status of products are subject to change without notice. Prior to the purchase, please contact NEC TOKIN for updated product data.  
 ● Please request for a specification sheet for detailed product data prior to the purchase.  
 ● Before using the product in this catalog, please read "Precautions" and other safety precautions listed in the printed version catalog.

# Resin coated type multilayer piezoelectric actuators

## AE Series

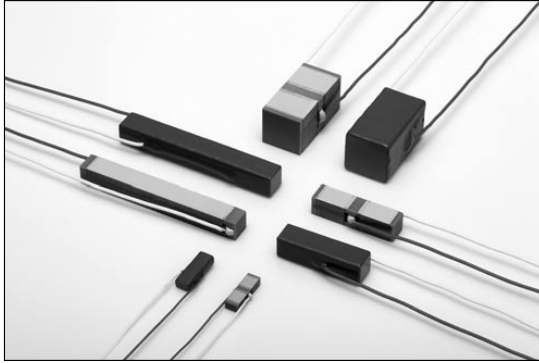

### Outline

Multilayer piezoelectric actuators are ceramic elements for converting electrical energy into mechanical energy such as displacement or force by utilizing the piezoelectric longitudinal effect.

NEC TOKIN's multilayer piezoelectric actuators are produced based on our unique element structure design and using originally developed piezoelectric ceramic materials with high electrostrictive factors. Compared to conventional piezoelectric actuators, they are smaller in size but can generate higher displacement and force at low voltages.

Especially, the resin-coated AE series actuators feature compact size and wide variety in shape for applications such as ultra-fine positioning mechanisms and drive sources.

### Features

- Large generated force: 3,500 N/cm<sup>2</sup> (typ.)
- High-speed response: Driving up to about 1/3 of self-resonant frequency (in several ten kHz) is possible.
- Accurate positioning: Controllable in nm order.
- Low power consumption: Can be retained at the leakage current state (100 μA or less) .
- Very small size: 1/10 or smaller than conventional multilayer actuators (specific volume)

### Applications

Auto focusing of cell phone camera, Image stabilization of DSC, Positioning, Motors, Pumps, Valves, Vibration source, Vibration controls, Sensors, Mirror / Prism positioning, Manipulators, AFM, Printer, etc

### Numbering system

Example: **AE 0505 D16 XXX F**

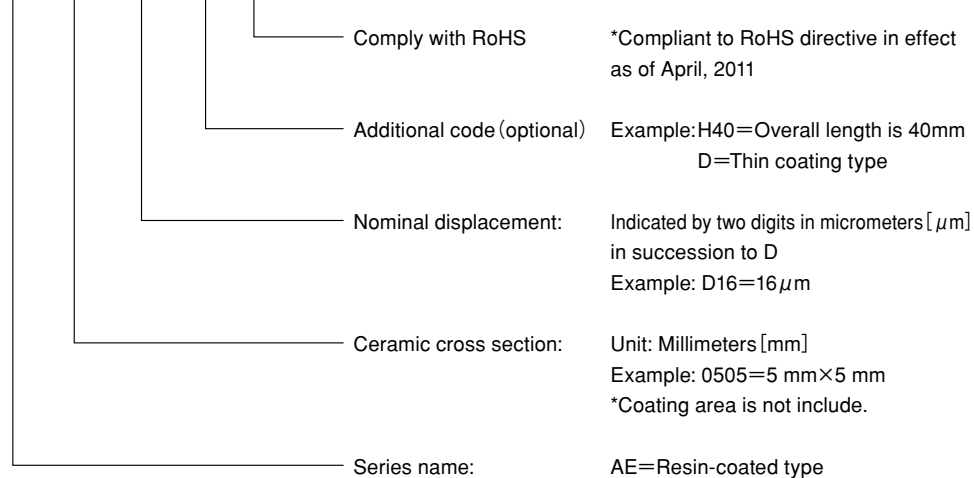

- All specifications in this catalog and production status of products are subject to change without notice. Prior to the purchase, please contact NEC TOKIN for updated product data.
- Please request for a specification sheet for detailed product data prior to the purchase.
- Before using the product in this catalog, please read "Precautions" and other safety precautions listed in the printed version catalog.

## Standard Parts List

Model	Displacement [ $\mu\text{m}$ ]	Overall length [mm]	Generated force [N]	Stiffness [N/ $\mu\text{m}$ ]	Resonance frequency [kHz]	Capacitance [ $\mu\text{F}$ ]	Insulation resistance [M $\Omega$ ]
	Maximum driving voltage [150VDC]						
AE0203D04F	4.6 $\pm$ 1.5	5	200	43.5	261	0.09	100
AE0203D04DF							
AE0203D08F	9.1 $\pm$ 1.5	10	200	22.0	138	0.18	100
AE0203D08DF							
AE0203D16F	17.4 $\pm$ 2.0	20	200	11.5	69	0.35	50
AE0203D16DF							
AE0203D44H40F	42.0 $\pm$ 6.6	40	200	4.8	34	0.82	20
AE0203D44H40DF							
AE0505D08F	9.1 $\pm$ 1.5	10	850	93.4	138	0.75	50
AE0505D08DF							
AE0505D16F	17.4 $\pm$ 2.0	20	850	48.9	69	1.4	10
AE0505D16DF							
AE0505D44H40F	42.0 $\pm$ 6.6	40	850	20.2	34	3.4	5
AE0505D44H40DF							
AE1010D16F	18.4 $\pm$ 3.5	20	3,500	190.2	69	5.4	5
AE1010D16DF							
AE1010D44H40F	42.0 $\pm$ 6.6	40	3,500	83.3	34	13.6	2
AE1010D44H40DF							
AE1414D16F	18.4 $\pm$ 3.5	20	7,000	380.4	69	10.8	2
AE2525D15F	15.6 $\pm$ 2.0	20	20,000	1,282.0	69	30.5	0.4

\*Tow coating types are available. AE \* \* \* \* D \* \* DF has thinner coating thickness.

\*For detail information of measurement conditions and outer dimension, please refer to "Performance" and "Outer Dimension" sections.

## Performance

Item	Standard	Conditions
Operating temperature range	- 25 to + 85°C	When applied with a DC voltage: Ambient temperature When driven by an AC voltage: Ambient temperature + Temperature rise due to generated heat
Recommended Storage condition	- 5 to + 40°C / less than 40%R.H	Recommend storage at room temperature. No condensation.
Maximum driving voltage	150VDC	
Displacement	See the standard parts list	At 150VDC
Generated force (compression resistance)	See the standard parts list	The force required for restricting the displacement to 0 when the maximum driving voltage is applied.
Capacitance	See the standard parts list	f = 1kHz, V = 1Vrms
Capacitance allowance	+ / - 20 %	
Dissipation factor	5% or less	
Insulation resistance	See the standard parts list	Value obtained in 1 minute at 150 VDC
Resonance frequency	See the standard parts list	With both ends of element in free state Typical value of the element under our test conditions
Tensile strength	1/10 of generated force	Typical value of the element under our test conditions
Young's modulus	4.4 $\times 10^{10}$ N/m <sup>2</sup>	Typical value of the element under our test conditions
Temperature cycle test	Displacement: Initial value $\pm$ 20% Capacitance: Initial value $\pm$ 30% tan $\delta$ : Less than initial rated value Insulation resistance: 1M $\Omega$ or more Appearance: No noticeable defect	Room temperature (3 min) -25°C (30 min.) Room temperature (3 min) +85°C (30 min) Repetition of 10 cycles of the above



- All specifications in this catalog and production status of products are subject to change without notice. Prior to the purchase, please contact NEC TOKIN for updated product data.
- Please request for a specification sheet for detailed product data prior to the purchase.
- Before using the product in this catalog, please read "Precautions" and other safety precautions listed in the printed version catalog.

## Outer Dimensions

Overall length 5,10 and 20mm Products

Overall length 40mm Product

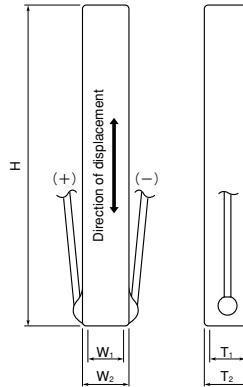
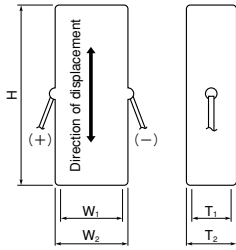

Note:

Factory-shipped polarization : Red lead wire = (+) ,  
White lead wire = (-)

Above drawings do not include dimension of wire connection area and diameter of the wire. Please contact us for details.

Unit : mm

Model	T <sub>1</sub>	W <sub>1</sub>	H	T <sub>2</sub>	W <sub>2</sub>	L
AE0203D04F	2 ± 0.1	3 ± 0.1	5 ± 0.1	3.5Max.	4.5Max.	100
AE0203D04DF				2.4Max.	3.4Max.	
AE0203D08F	2 ± 0.1	3 ± 0.1	10 ± 0.1	3.5Max.	4.5Max.	100
AE0203D08DF				2.4Max.	3.4Max.	
AE0203D16F	2 ± 0.1	3 ± 0.1	20 ± 0.1	3.5Max.	4.5Max.	100
AE0203D16DF				2.4Max.	3.4Max.	
AE0203D44H40F	2 ± 0.1	3 ± 0.1	40 ± 0.1	3.5Max.	4.5Max.	100
AE0203D44H40DF				2.4Max.	3.4Max.	
AE0505D08F	5 ± 0.1	5 ± 0.1	10 ± 0.1	6.5Max.	6.5Max.	100
AE0505D08DF				5.4Max.	5.4Max.	
AE0505D16F	5 ± 0.1	5 ± 0.1	20 ± 0.1	6.5Max.	6.5Max.	100
AE0505D16DF				5.4Max.	5.4Max.	
AE0505D44H40F	5 ± 0.1	5 ± 0.1	40 ± 0.1	6.5Max.	6.5Max.	100
AE0505D44H40DF				5.4Max.	5.4Max.	
AE1010D16F	10 ± 0.1	10 ± 0.1	20 ± 0.1	11.5Max.	11.5Max.	100
AE1010D16DF				10.4Max.	10.4Max.	
AE1010D44H40F	10 ± 0.1	10 ± 0.1	40 ± 0.1	11.5Max.	11.5Max.	100
AE1010D44H40DF				10.4Max.	10.4Max.	
AE1414D16F	14.2 ± 0.1	14.2 ± 0.1	20 ± 0.1	15.7Max.	15.7Max.	100
AE2525D15F	25.1 ± 0.1	25.1 ± 0.1	20 ± 0.1	26.6Max.	26.6Max.	100

\*L = Length of lead wire



- All specifications in this catalog and production status of products are subject to change without notice. Prior to the purchase, please contact NEC TOKIN for updated product data.
- Please request for a specification sheet for detailed product data prior to the purchase.
- Before using the product in this catalog, please read "Precautions" and other safety precautions listed in the printed version catalog.

**Wire diameter**

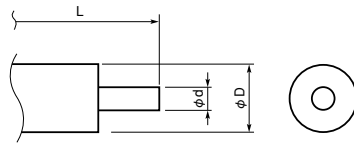

φd =Diameter of lead wire  
 φD =Outer diameter including the thickness of coating  
 L =Length of lead wire

Lead wire: Copper wire with Tin plating  
 Coating: PTFE (Polytetrafluoroethylene)

Unit : mm

Model Number	φ d	φ D	L	AWG	UL number
AE0203D04F	0.3	0.5	100	32	1993
AE0203D04DF					
AE0203D08F	0.3	0.5	100	32	1993
AE0203D08DF					
AE0203D16F	0.3	0.5	100	32	1993
AE0203D16DF					
AE0203D44H40F	0.3	0.5	100	32	1993
AE0203D44H40DF					
AE0505D08F	0.3	0.5	100	32	1993
AE0505D08DF					
AE0505D16F	0.5	0.8	100	26	1371
AE0505D16DF					
AE0505D44H40F	0.5	0.8	100	26	1371
AE0505D44H40DF					
AE1010D16F	0.5	0.8	100	26	1371
AE1010D16DF					
AE1010D44H40F	0.5	0.8	100	26	1371
AE1010D44H40DF					
AE1414D16F	0.5	0.8	100	26	1371
AE2525D15F	0.5	0.8	100	26	1371

**Special Design Parts**

Non-standard parts are available per order basis. Please use the guideline below as reference regarding generated displacement and generated force.

- Displacement: Roughly proportional to the element length
- Generated force: Roughly proportional to the sectional area of the element
- Shape: Product cross-section: 1mm × 1mm square or larger
- Product length: 1mm or longer
- Can be provided in cylindrical ring or other shapes.

Please contact us for further details.

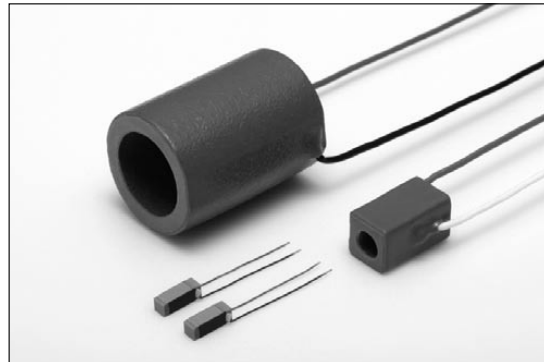

**Example of special design parts**

	AL1.65 × 1.65 × 5DF	AE1.65 × 1.65 × 5DF	Condition
Ceramic Dimension	1.65 × 1.65 × 5mm	1.65 × 1.65 × 5mm	
Maximum Operating Voltage (V)	± 10V	150VDC	
Displacement	(300nm <sub>p-p</sub> )	(4 μm)	At maximum operating voltage
Capacitance (nF)	90	43	f=1 kHz, V=1 Vrms
Operating Temperature	- 25 ~ +85°C		



Small size piezo actuator



- All specifications in this catalog and production status of products are subject to change without notice. Prior to the purchase, please contact NEC TOKIN for updated product data.
- Please request for a specification sheet for detailed product data prior to the purchase.
- Before using the product in this catalog, please read "Precautions" and other safety precautions listed in the printed version catalog.

## Characteristic Data

Fig-1 Voltage vs. Displacement

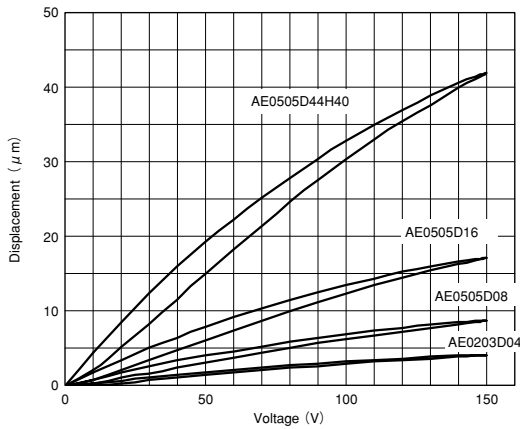

Fig-2 Generated force vs. Displacement of AE0505D16F in Driving voltage

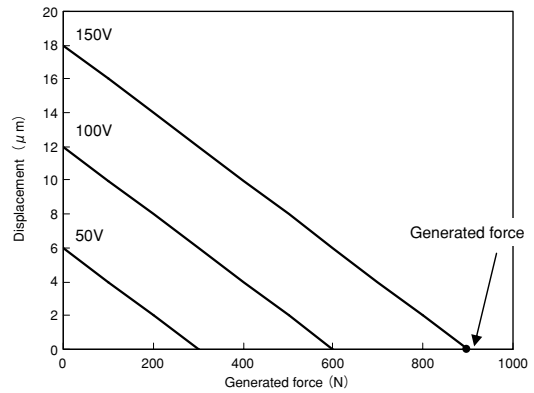

Fig-3 Generated force vs. Displacement-1

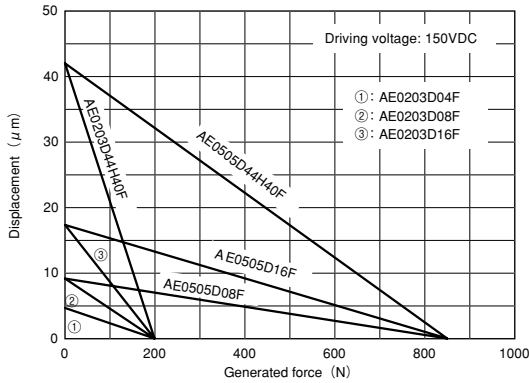

Fig-4 Generated force vs. Displacement-2

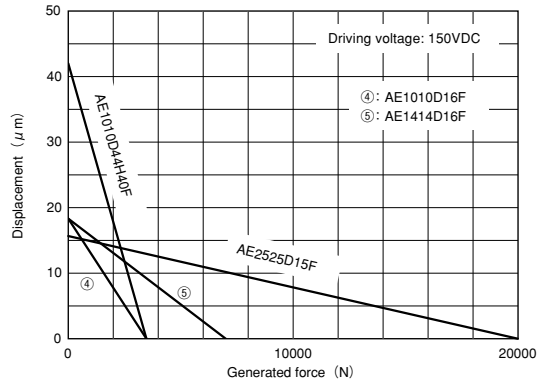
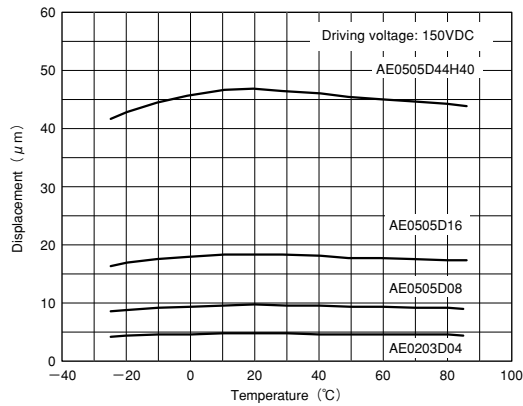

Fig-5 Temperature vs. Displacement



\* Listed data are reference values. For the voltage vs. displacement characteristic, the same length of piezo series shows the same voltage vs. displacement characteristic.

\* Definition of generated force for Fig-2, Fig-3 and Fig-4;

Force is the force required for restricting the displacement to 0 when the maximum driving voltage is applied.



- All specifications in this catalog and production status of products are subject to change without notice. Prior to the purchase, please contact NEC TOKIN for updated product data.
- Please request for a specification sheet for detailed product data prior to the purchase.
- Before using the product in this catalog, please read "Precautions" and other safety precautions listed in the printed version catalog.

Fig-6 Temperature vs. Displacement

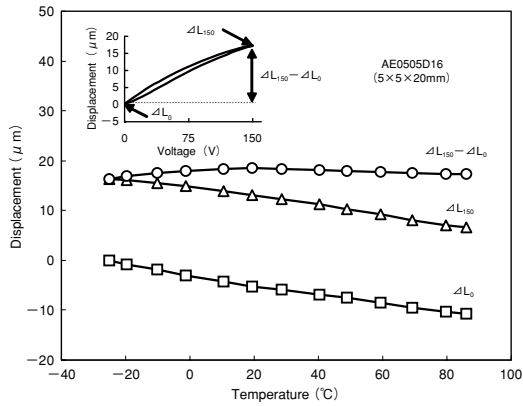

Fig-7 Voltage vs. Displacement in time

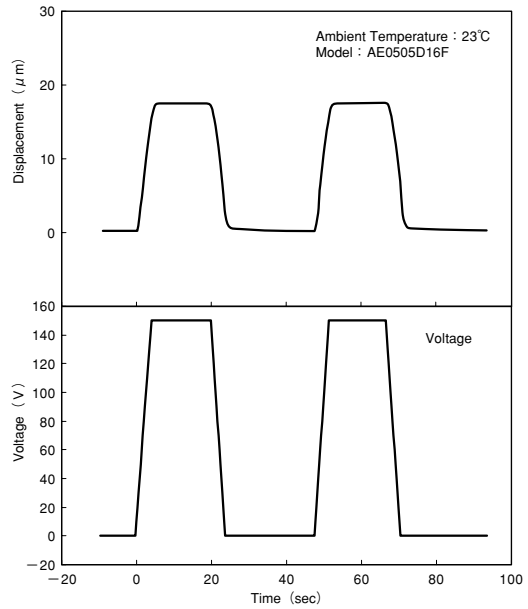

Fig-8 Heat generation vs. Drive frequency-1

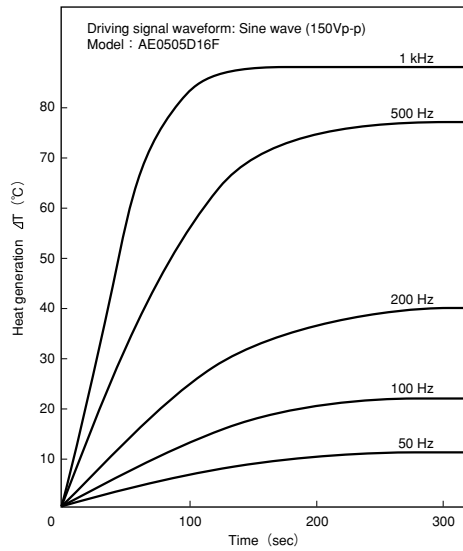
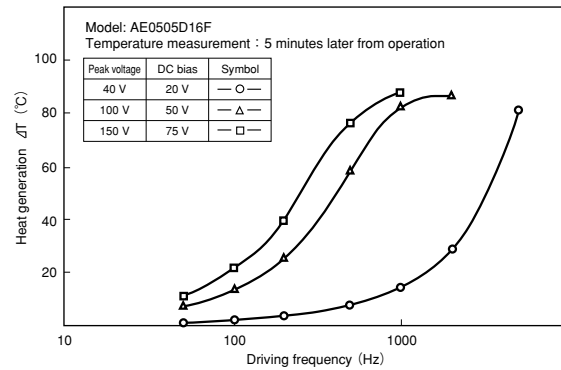

Fig-9 Heat generation vs. Drive frequency-2



- All specifications in this catalog and production status of products are subject to change without notice. Prior to the purchase, please contact NEC TOKIN for updated product data.
- Please request for a specification sheet for detailed product data prior to the purchase.
- Before using the product in this catalog, please read "Precautions" and other safety precautions listed in the printed version catalog.

# Metal sealed type multilayer piezoelectric actuators

**ASB Series (85°C rated), ASL series (150°C rated), AHB series (High displacement model)**



## Outline

Multilayer piezoelectric actuators convert electrical energy into mechanical energy such as displacement or force by making use of the piezoelectric longitudinal effect. NEC TOKIN's multilayer piezoelectric actuators are produced based on our unique element structure design by making use of originally developed piezoelectric ceramic materials with high electrostrictive factors. Compared to conventional piezoelectric actuators, they are smaller in size but can generate higher displacements and forces at low voltages. Especially, the metal sealed ASB/ASL and AHB series actuators are much less influenced by ambient humidity because of insulation from the atmosphere. As a result, long service life and high performance never experienced in the past have been attained to allow use in various applications such as semiconductor device production equipment and optical communication equipment which require high reliability.

## Features

- High reliability: Realization of MTTF = 36,000 hours (at 85°C and 100 V)
- Easier installation into equipments thanks to the built-in pre-load mechanism and mounting attachment
- Minimum mechanical abrasion
- Large generated force: 800 N
- Accurate positioning: Controllable in nm order

## Applications

Fine adjustment of various X-Y tables steppers, Mirror/prism positioning, Linear motors, Fluid flow control valve drive, Vibration source, Manipulators, etc.

## Numbering system

Example: **AS B 170 C 801 N P 0 LF**

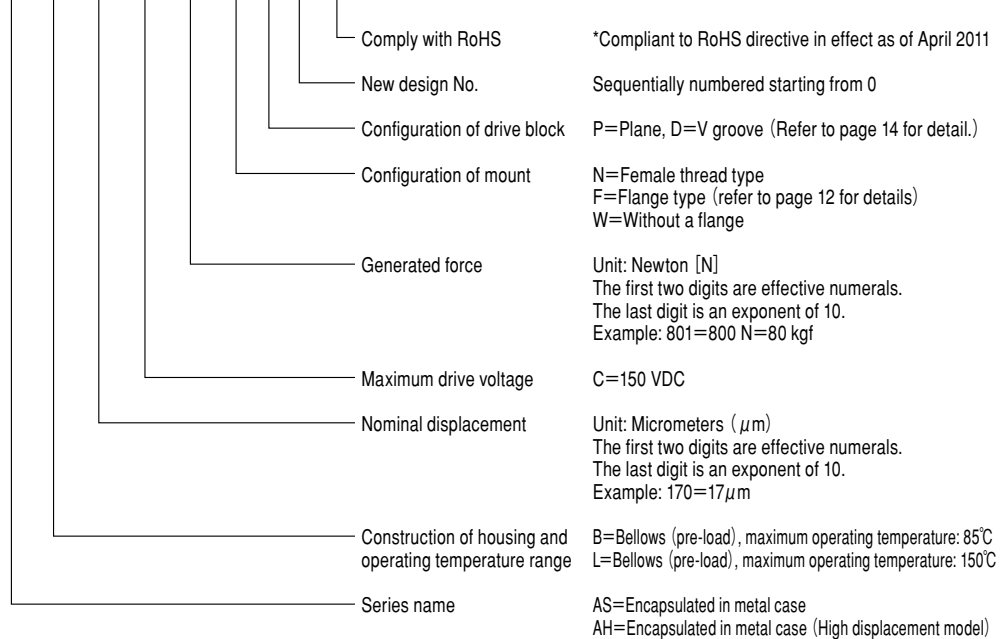

- All specifications in this catalog and production status of products are subject to change without notice. Prior to the purchase, please contact NEC TOKIN for updated product data.
- Please request for a specification sheet for detailed product data prior to the purchase.
- Before using the product in this catalog, please read "Precautions" and other safety precautions listed in the printed version catalog.

## Standard Parts List

### • ASB series

Model	Displacement [ $\mu\text{m}$ ]	Generated force [N]	Resonance frequency [kHz]	Capacitance [ $\mu\text{F}$ ]	Insulation resistance [ $\text{M}\Omega$ ]
	Maximum driving voltage [150VDC]				
ASB170C801 $\blacksquare$ ●0LF	17.0 $\pm$ 3	800	14	1.5	30
ASB170C801W ●1-A0LF					
ASB340C801 $\blacksquare$ ●0LF	34.0 $\pm$ 6	800	12	3.0	15
ASB340C801W ●1-A0LF					
ASB510C801 $\blacksquare$ ●0LF	51.0 $\pm$ 9	800	10	4.5	10
ASB510C801W ●1-A0LF					
ASB680C801 $\blacksquare$ ●0LF	68.0 $\pm$ 12	800	8	6.0	5
ASB680C801W ●1-A0LF					
ASB170C201WP1-A0LF	20.0 $\pm$ 3	200	37	0.5	100

\*Note:  $\blacksquare$  in model number has "N" or "F" letter.

● in model number has "P" or "D" letter.

Example) ASB170C801NP0LF, ASB510C801WD1-A0LF

\*Model number, ASB \* \* \* C801W ●1-A1LF is the model without a flange.

\*For detail information of measurement conditions and outer dimension, please refer to "Performance" and "Outer Dimension" sections.

### • ASL series

Model	Displacement [ $\mu\text{m}$ ]	Generated force [N]	Resonance frequency [kHz]	Capacitance [ $\mu\text{F}$ ]	Insulation resistance [ $\text{M}\Omega$ ]
	Maximum driving voltage [150VDC]				
ASL170C801 $\blacksquare$ ●0LF	19.0 $\pm$ 3	800	14	1.34	30
ASL340C801 $\blacksquare$ ●0LF	39.0 $\pm$ 6	800	12	2.55	15
ASL510C801 $\blacksquare$ ●0LF	58.0 $\pm$ 9	800	10	3.84	10
ASL680C801 $\blacksquare$ ●0LF	77.0 $\pm$ 12	800	8	5.07	5

\*Note:  $\blacksquare$  in model number has "N" or "F" letter.

● in model number has "P" or "D" letter.

Example) ASL170C801FP0LF

\*No flange type is also available for ASL-series. Please contact us for detail.

### • AHB series

Model	Displacement [ $\mu\text{m}$ ]	Generated force [N]	Resonance frequency [kHz]	Capacitance [ $\mu\text{F}$ ]	Insulation resistance [ $\text{M}\Omega$ ]
	Maximum driving voltage [150VDC]				
AHB550C801 $\blacksquare$ ●0LF	55.0 $\pm$ 8	800	12	6.4	10
AHB700C801 $\blacksquare$ ●0LF	70.0 $\pm$ 15	800	8	8.2	5
AHB800C801 $\blacksquare$ ●0LF	80.0 $\pm$ 15	800	8	9.3	5
AHB800C302WD1-A0LF	80.0 $\pm$ 15	3000	8	37.0	2

\*Note:  $\blacksquare$  in model number has "N" or "F" letter.

● in model number has "P" or "D" letter.

Example) AHB800C801NP0LF

\*No flange type is also available for AHB-series. Please contact us for detail.

\*For detail information of measurement conditions and outer dimension, please refer to "Performance" and "Outer Dimension" sections.

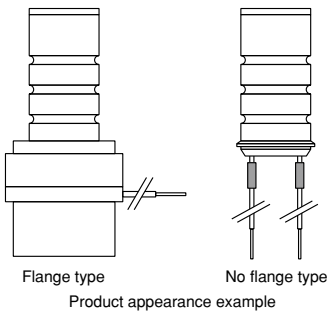

- All specifications in this catalog and production status of products are subject to change without notice. Prior to the purchase, please contact NEC TOKIN for updated product data.
- Please request for a specification sheet for detailed product data prior to the purchase.
- Before using the product in this catalog, please read "Precautions" and other safety precautions listed in the printed version catalog.

**Performance**

Item	Standard	Conditions
<b>Operating temperature range</b>	ASB/AHB : - 25 to + 85°C ASL : - 40 to + 150°C	When applied with DC voltage: Ambient temperature When driven by pulse: Ambient temperature + Temperature rise due to generated heat
<b>Recommended Storage condition</b>	- 5 to + 40°C	
<b>Maximum driving voltage</b>	150VDC	
<b>Displacement</b>	See the standard parts list	At 150VDC
<b>Generated force (compression resistance)</b>	See the standard parts list	The force required for restricting the displacement to 0 when the maximum driving voltage is applied.
<b>Capacitance</b>	See the standard parts list	f = 1kHz, V = 1Vrms
<b>Capacitance tolerance</b>	+ / - 20%	
<b>Dissipation factor</b>	5% or less	
<b>Insulation resistance</b>	See the standard parts list	Value obtained in 1 minute at 150 VDC
<b>Resonance frequency</b>	See the standard parts list	With both ends of element in free state Typical value of the element under our test conditions
<b>Airtightness</b>	$1 \times 10^{-8}$ atm cc/sec or less	
<b>Temperature cycle test</b>	Displacement: Initial value $\pm$ 30% Capacitance: Initial value $\pm$ 30% tan $\delta$ : Less than initial rated value Insulation resistance: 1 M $\Omega$ or more Appearance: No noticeable defect	ASB, AHB                      ASL Room temperature (3 min)    Room temperature (3 min) - 25°C (30 min)                - 40°C (30 min) Room temperature (3 min)    Room temperature (3 min) + 85°C (30 min)                + 150°C (30 min) Repetition of 10 cycles of the above
<b>High-temperature shelf test</b>	Displacement: Initial value $\pm$ 30% Capacitance: Initial value $\pm$ 30% tan $\delta$ : Less than initial rated value Insulation resistance: 1 M $\Omega$ or more Appearance: No noticeable defect	Temperature    ASB, AHB: 85 $\pm$ 2°C ASL: 150 $\pm$ 2°C Time             1,000 $\pm$ 48 h
<b>Solvent resistance test</b>	Displacement: Initial value $\pm$ 30% Capacitance: Initial value $\pm$ 30% tan $\delta$ : Less than initial rated value Insulation resistance: 1 M $\Omega$ or more Appearance: No noticeable defect Mark: Easily legible	Solvent: Isopropyl alcohol Temperature: 23 $\pm$ 5°C Time: Immersion for 1 min
<b>Heat resistance test</b>	Displacement: Initial value $\pm$ 30% Capacitance: Initial value $\pm$ 30% tan $\delta$ : Less than initial rated value Insulation resistance: 1 M $\Omega$ or more Appearance: No noticeable defect Mark: Easily legible	Temperature: 150 $\pm$ 3°C Time: 96 $\pm$ 4 h



- All specifications in this catalog and production status of products are subject to change without notice. Prior to the purchase, please contact NEC TOKIN for updated product data.
- Please request for a specification sheet for detailed product data prior to the purchase.
- Before using the product in this catalog, please read "Precautions" and other safety precautions listed in the printed version catalog.

**Dimensions (Common to ASB, ASL and AHB Series)**

● Female thread type

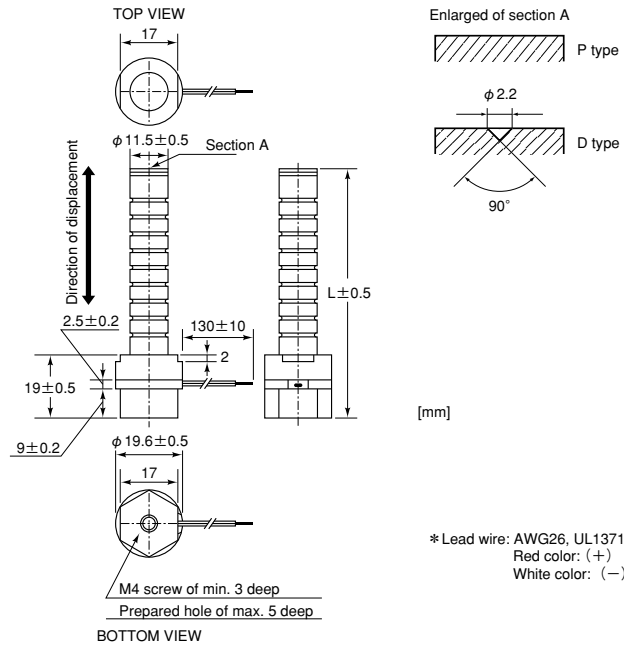

Model	L (mm)
ASB170C801NP0LF	38.4
ASL170C801NP0LF	
ASB340C801NP0LF	58.4
ASL340C801NP0LF	
ASB510C801NP0LF	78.4
ASL510C801NP0LF	
ASB680C801NP0LF	98.4
ASL680C801NP0LF	

Model	L (mm)
AHB550C801NP0LF	58.4
AHB700C801NP0LF	78.4
AHB800C801NP0LF	78.4

\* Both P type and D type have the same overall lengths

\* Lead wire: AWG26, UL1371  
Red color: (+)  
White color: (-)

● Flange type

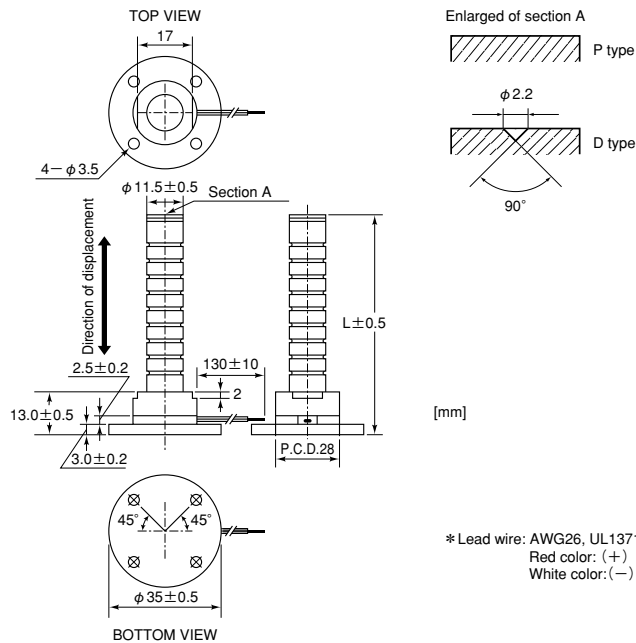

Model	L (mm)
ASB170C801FP0LF	32.4
ASL170C801FP0LF	
ASB340C801FP0LF	52.4
ASL340C801FP0LF	
ASB510C801FP0LF	72.4
ASL510C801FP0LF	
ASB680C801FP0LF	92.4
ASL680C801FP0LF	

Model	L (mm)
AHB550C801FP0LF	52.4
AHB700C801FP0LF	72.4
AHB800C801FP0LF	72.4

\* Both P type and D type have the same overall lengths

\* Lead wire: AWG26, UL1371  
Red color: (+)  
White color: (-)



- All specifications in this catalog and production status of products are subject to change without notice. Prior to the purchase, please contact NEC TOKIN for updated product data.
- Please request for a specification sheet for detailed product data prior to the purchase.
- Before using the product in this catalog, please read "Precautions" and other safety precautions listed in the printed version catalog.

● Without flange type

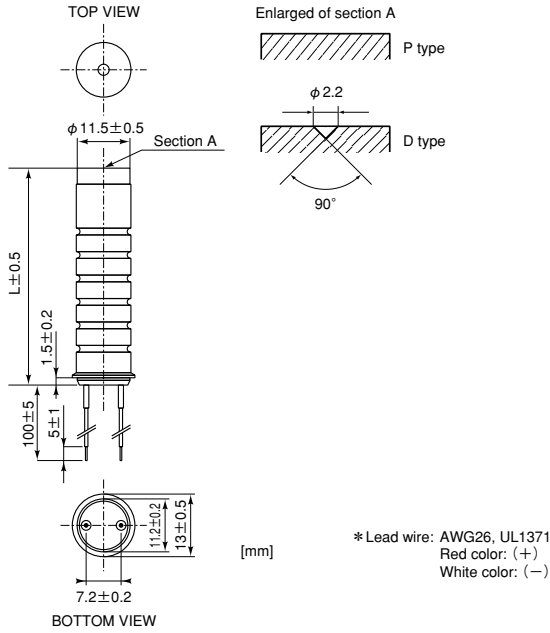

Model	L (mm)
ASB170C801W ● 1-A0LF	24.4
ASL170C801W ● 1-A0LF	
ASB340C801W ● 1-A0LF	44.4
ASL340C801W ● 1-A0LF	
ASB510C801W ● 1-A0LF	64.4
ASL510C801W ● 1-A0LF	
ASB680C801W ● 1-A0LF	84.4
ASL680C801W ● 1-A0LF	

Model	L (mm)
AHB550C801W ● 1-A0LF	44.4
AHB700C801W ● 1-A0LF	64.4
AHB800C801W ● 1-A0LF	64.4

\* Note: ● in model number has "P" or "D" letter.  
Example) AHB800C801NP0LF.

● ASB170C201WP1-A0LF

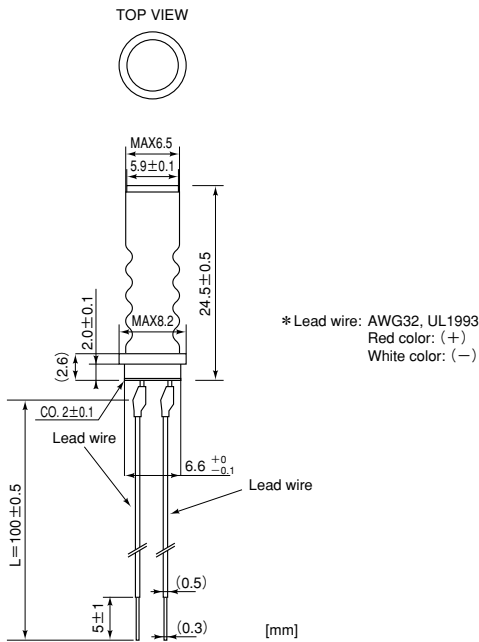

● AHB800C302WD1-A0LF

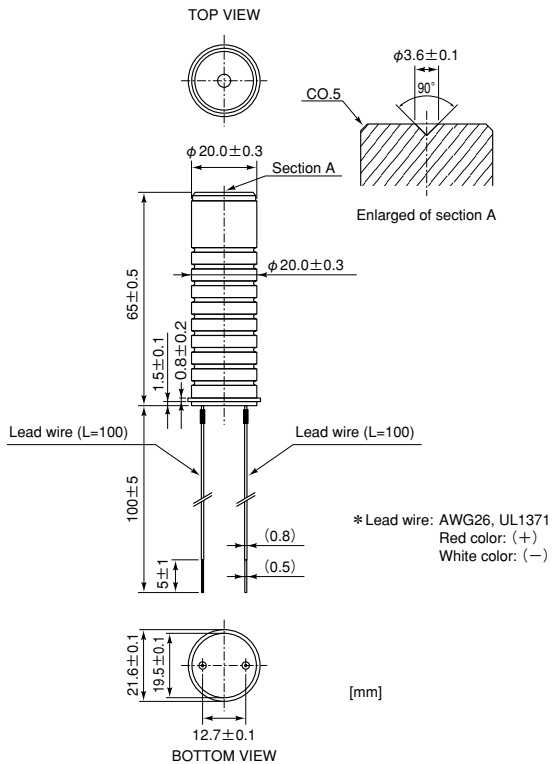

- All specifications in this catalog and production status of products are subject to change without notice. Prior to the purchase, please contact NEC TOKIN for updated product data.
- Please request for a specification sheet for detailed product data prior to the purchase.
- Before using the product in this catalog, please read "Precautions" and other safety precautions listed in the printed version catalog.

**Example of fixing method for without flange type**

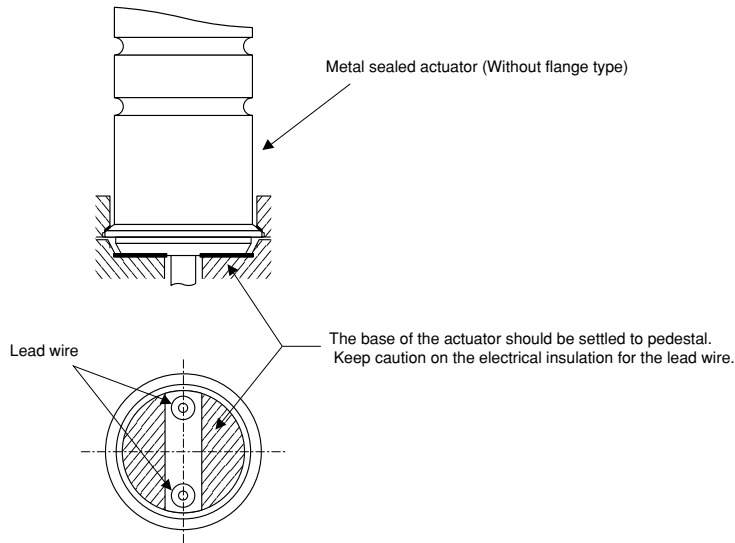

**Characteristic Data**

- ASB series

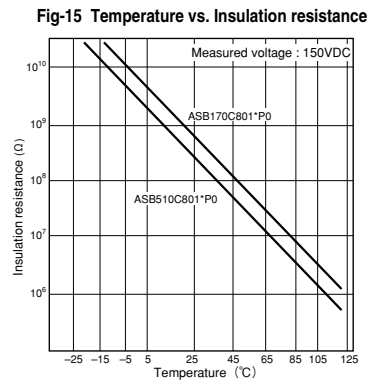
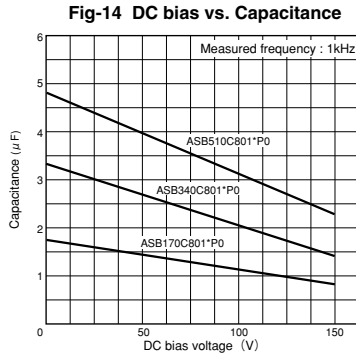
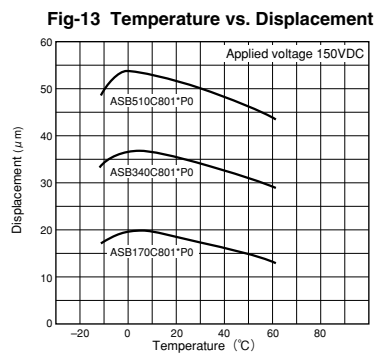
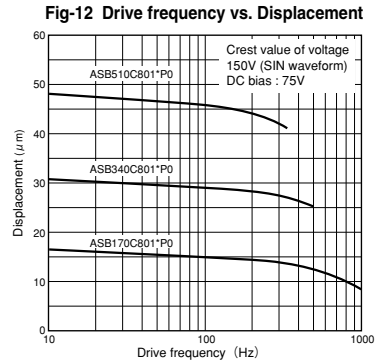
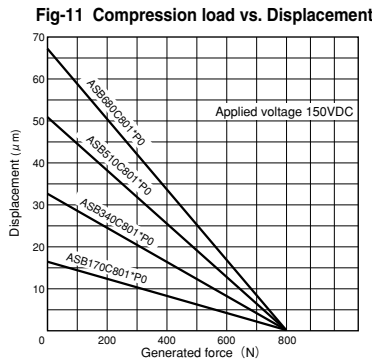
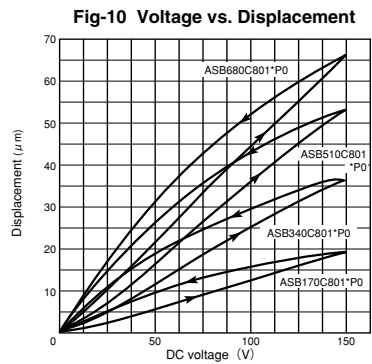

- All specifications in this catalog and production status of products are subject to change without notice. Prior to the purchase, please contact NEC TOKIN for updated product data.
- Please request for a specification sheet for detailed product data prior to the purchase.
- Before using the product in this catalog, please read "Precautions" and other safety precautions listed in the printed version catalog.

• ASL series performance compare with ASB series

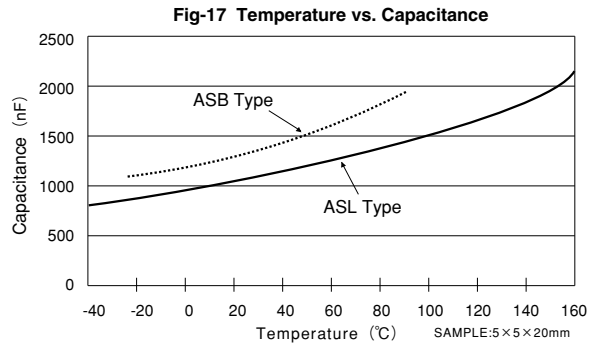
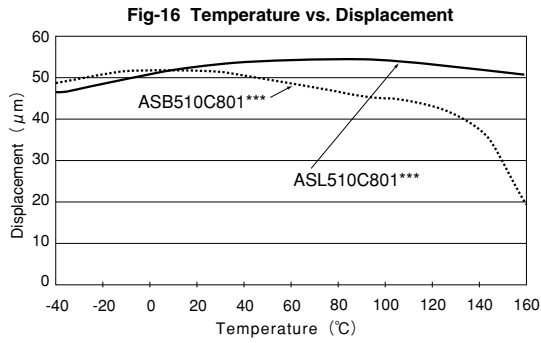

• AHB series

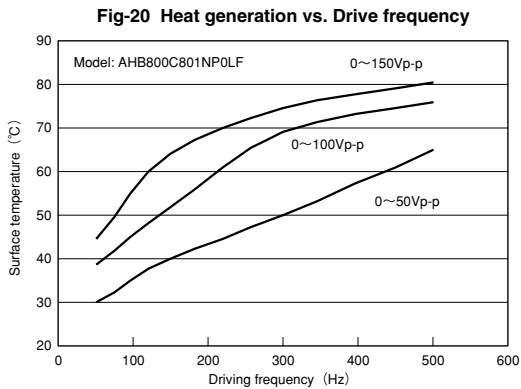
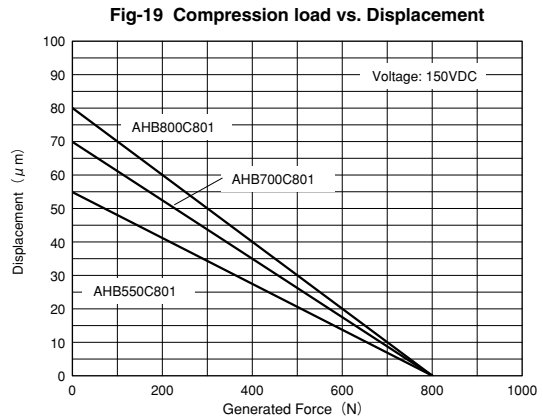
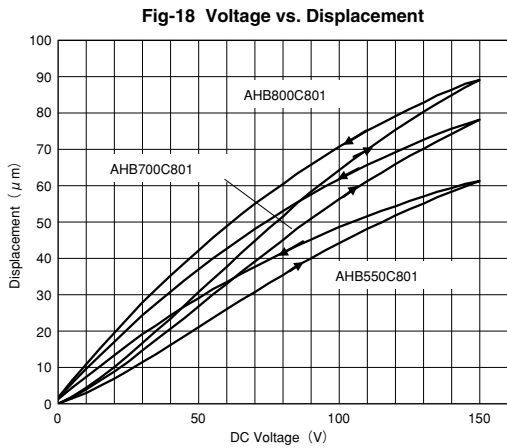

Driving waveform: SIN wave 0~Vp-p  
 Temperature measurement : 10 minutes after the device is in operation



- All specifications in this catalog and production status of products are subject to change without notice. Prior to the purchase, please contact NEC TOKIN for updated product data.
- Please request for a specification sheet for detailed product data prior to the purchase.
- Before using the product in this catalog, please read "Precautions" and other safety precautions listed in the printed version catalog.

**Application Example**

Semiconductor manufacturing system	Positioning of stepper, Clamping actuator of wire bonding, Valve actuation of mass flow controller, Actuator of shaker, Actuator of damping system, Positioning of light source.
Precision machinery, Mechatronics	Sewing machine, Robot, Vibration of parts feeder, Positioning of equipment, Pressure sensor
Home appliance, Audio equipment	Actuator of pump, Speaker
Imaging equipment	Actuator of resolution improvement, Actuator of autofocusing, Actuator of damping
Computer, OA equipment	Pressure sensor, Positioning of memory device (data storage or others)
Optical equipment	Positioning of stage, Actuator of autofocusing, Actuator of shaker and damping system
Communications	Polarization control, Wavelength control
Medical equipment	Micropump, Ultrasonic transducer
Measuring instrument	Pressure sensor, Acceleration sensor, Fine positioning
Automobile	Vibration control



- All specifications in this catalog and production status of products are subject to change without notice. Prior to the purchase, please contact NEC TOKIN for updated product data.
- Please request for a specification sheet for detailed product data prior to the purchase.
- Before using the product in this catalog, please read "Precautions" and other safety precautions listed in the printed version catalog.

# Reliability

Majority of failure mode of multilayer piezoelectric actuators is the short circuit due to degraded insulation. Though the cause of degradation of insulation has not been clarified perfectly, it has been found that the failure rate varies greatly between static uses (DC voltage application) and dynamic uses (pulse voltage application). Like other electrical components, piezo actuators can be influenced by humidity as well as applied voltage and ambient temperature. NEC TOKIN has added the metal sealed type piezo actuators featuring high reliability by eliminating influence of the ambient atmosphere.

This section describes reliability guidelines for static and dynamic usages of the resin-coated and metal sealed types actuators.

Reliability of our multilayer piezoelectric actuators is represented by MTTF (mean time to failure) in case of static usage. Though the number of repetitions is considered to be used to represent the reliability in the case of dynamic usage, the accurate relationship between the indicator and cause has not been determined because of various influential causes and the mutual action between them. For the present, therefore, only the obtained data and our concept are described.

## (1) Resin-coated Type (AE Series)

### a. DC voltage application

The acceleration factors have been obtained empirically for each of the drive voltage, ambient temperature and relative humidity based on many experimental result. The MTTF<sub>r</sub> in actual applications is estimated using equation (1) below with MTTF<sub>s</sub> observed under accelerated condition as the reference value.

$$MTTF_r = MTTF_s \times A_v \times A_h \times A_t \quad \dots (1)$$

MTTF<sub>r</sub> : Estimated value

MTTF<sub>s</sub> : Reference value (=500h)

$$A_v : \text{Acceleration factor for drive voltage} = \left(\frac{150}{V_r}\right)^{3.2} \quad V_r : \text{Actual voltage (V)}$$

$$A_h : \text{Acceleration factor for relative humidity} = \left(\frac{90}{H_r}\right)^{4.9} \quad H_r : \text{Actual relative humidity (RH\%)}$$

$$A_t : \text{Acceleration factor for ambient temperature} = 1.5^{\frac{40-T_r}{10}} \quad T_r : \text{Actual ambient temperature(}^\circ\text{C)}$$

[Example] The following calculation is made for the case of use at 25°C, 60% RH and 100 V:

$$\begin{aligned} MTTF_r &= 500 \times \left(\frac{150}{100}\right)^{3.2} \times \left(\frac{90}{60}\right)^{4.9} \times 1.5^{\frac{40-25}{10}} \\ &= 500 \times 3.66 \times 7.29 \times 1.84 \\ &\approx 24,500\text{h (2.8years)} \end{aligned}$$

### b. Pulse voltage application

When this element is driven by a pulse voltage, temperature rises as a result of heating due to dielectric loss of ceramics. Therefore, the element is not likely to be influenced by the humidity, thus extending the service life greatly. Since this effect is affected by the element shape, pulse waveform and frequency, it cannot be calculated by an equation as in the case of DC voltage application.

In NEC TOKIN's testing on the AE0203D08, there was no failure confirmed after 0-150 V rectangular pulse wave was applied with 500 Hz for 500 hours (equivalent to 900 million pulses were applied).

Please pay attention to the physical damage due to ringing phenomenon caused by the fixed method of the element and the speed of the voltage rise.

Please refer to the separately printed literature, "NEC TOKIN Multilayer Piezoelectric Actuators User's Manual" for more detail.



- All specifications in this catalog and production status of products are subject to change without notice. Prior to the purchase, please contact NEC TOKIN for updated product data.
- Please request for a specification sheet for detailed product data prior to the purchase.
- Before using the product in this catalog, please read "Precautions" and other safety precautions listed in the printed version catalog.

**(2) Metal Sealed Type (ASB, ASL and AHB Series)**

a. DC voltage application

MTTF<sub>r</sub> of the metal sealed type under the actual operating conditions is calculated/estimated from the reference MTTF<sub>s</sub> and the acceleration factor as in the case of the resin-coated type. However since the internal element is sealed from the atmosphere, it is not influenced by the atmospheric humidity. Therefore, equation (2) below is used.

$$MTTF_r = MTTF_s \times A_v \times A_t \quad \dots (2)$$

MTTF<sub>r</sub> : Estimated value

MTTF<sub>s</sub> : Reference value (=36,000h)

$$A_v : \text{Acceleration factor for drive voltage} = \left(\frac{100}{V_r}\right)^2 \quad V_r : \text{Actual operating voltage (V)}$$

$$A_t : \text{Acceleration factor for ambient temperature} = 1.5^{\frac{85-T_r}{10}} \quad T_r : \text{Actual operating temperature (}^\circ\text{C)}$$

[Example] The following calculation is made for use at 25(c and 150 V:

$$\begin{aligned} MTTF_r &= 36,000 \times \left(\frac{100}{150}\right)^2 \times 1.5^{\frac{85-25}{10}} \\ &= 36,000 \times 0.44 \times 11.3 \\ &\approx 179,000\text{h (20.4years)} \end{aligned}$$

b. Pulse voltage application

Like the resin-coated type, it is extremely difficult to estimate reliability by using an equation in the metal sealed type because of the influence of the pulse waveform, frequency, etc. in addition to the voltage and ambient temperature.

In NEC TOKIN's testing on the ASB170C801NP0, there was no failure confirmed up to 1000 hours (equivalent to 100 million pulses were applied) under the conditions below.

[Conditions for evaluation]

Temperature: 85 ± 2°C

Humidity: 90 to 95% RH

Load: 200 N to 500 N (20 kgf to 50 kgf)

Drive voltage waveform: Rectangular wave, 30 Hz, 0 V to 100 V, duty ratio at 30%



# Guide to Use

## Fixing Method:

- Carefully prevent the piezo actuators from being bent, being twisted, or being applied tensile force.  
Reference: Guide for tolerance of twisting and tension

	Reference value	Remarks
Twisting force	$3 \times 10^{-1} \text{N} \cdot \text{m}$ or less	For an actuator which generates a force of 800 N (compression resistance)
Tension	50 N or less	

- Install the actuator so that the center axis of generated displacement is aligned with the center axis of the load.

### a. Resin-coated type

- Epoxy-based adhesives are recommended for bonding. Select adhesives that have high rigidity and allow minimum thickness so that the generation force and displacement cannot be deteriorated. Also do not form adhesives at the side of actuator.
- When thermosetting resin is used, perform polarizing treatment (see the caution section) again after the adhesive is settled.
- The resin-coated type is weak to tensile force because of its structure and may be broken when tensile force is applied onto the device. Using the device in the state that constantly applies compression is effective against any mechanical damage. The pressure applied to this element should be kept at 20 to 50% of the force generated by this element (compression resistance).
- Install the element so that the axis of generated displacement is vertical to the mounting surface.

### b. Metal sealed type

- Select the mounting bracket (female thread type or flange type) according to the mounting method, and install the element utilizing the bracket.
- Fix the element securely so that the generated force and displacement cannot be deteriorated.
- Connect the driven item at the displacement generating end after securing the mounting portion so that it avoids unnecessary stress applied at the time of installation.
- Though this product is designed to apply a compressive force to the internal element by the metal case, avoid any usages that cause bending, twisting, or tension force when the device is in use

## Example of Actuator mounting :

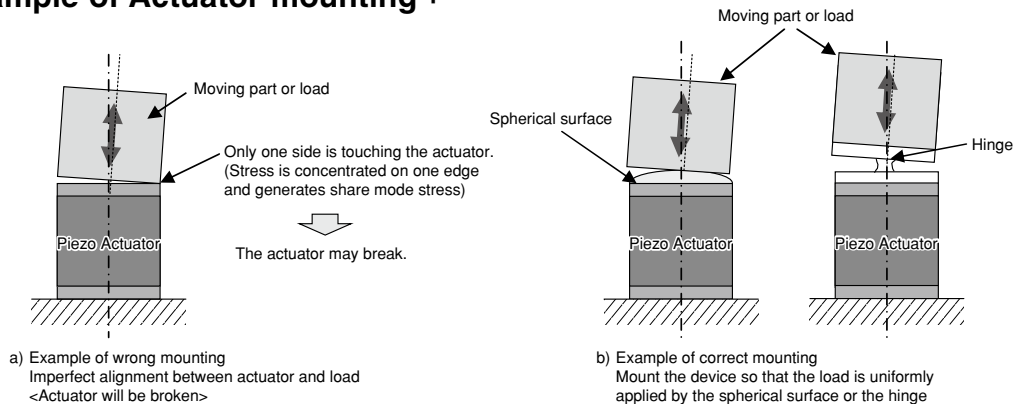

## Driving Method:

- Connect the red lead wire to the positive (+) terminal of the power supply. Also prevent reverse voltage application.
- Basically the voltage controls the aimed displacement and generated force. In driving, however, it is also necessary to take ringing due to the resonance or hysteresis of the element itself into consideration. In pulse driving, it is further necessary to pay sufficient attention to heat generation due to dielectric loss, charge/discharge current due to the capacitive component and the power output impedance as well. Please refer to the separately printed literature, "NEC TOKIN Multilayer Piezoelectric Actuators User's Manual"



- All specifications in this catalog and production status of products are subject to change without notice. Prior to the purchase, please contact NEC TOKIN for updated product data.
- Please request for a specification sheet for detailed product data prior to the purchase.
- Before using the product in this catalog, please read "Precautions" and other safety precautions listed in the printed version catalog.

**Generated force and load relation:**

Static load: No load value change when actuator moves.

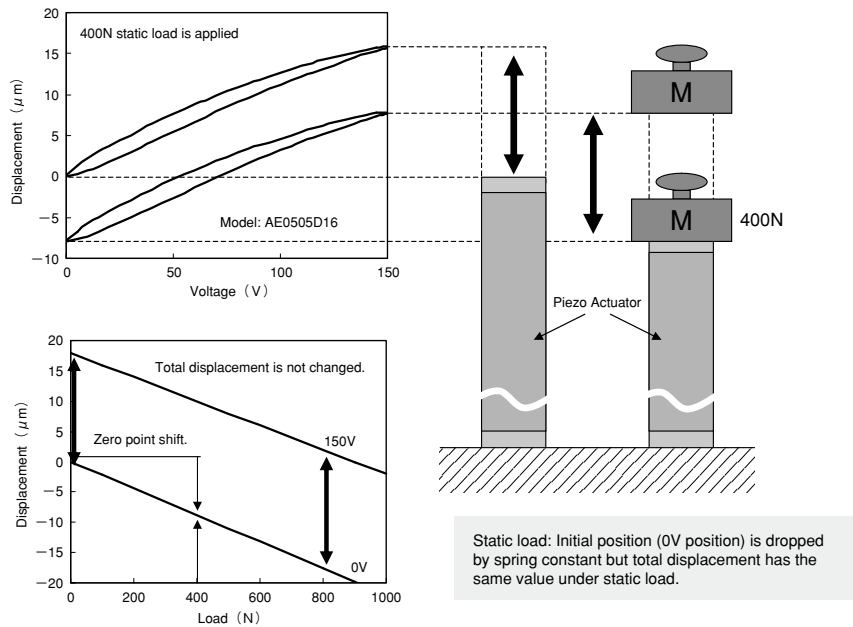

Fluctuating load: Load value changes by spring reaction when actuator moves.

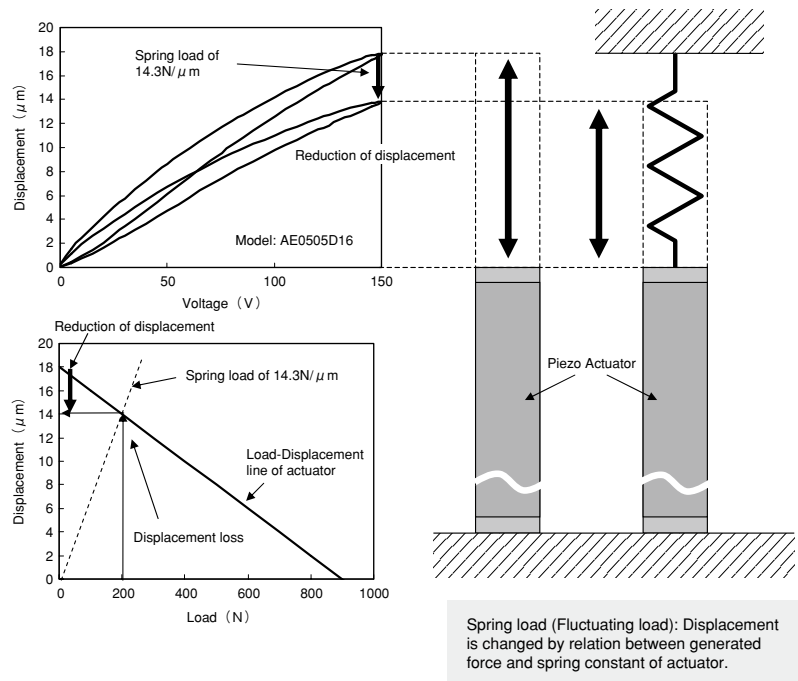

- All specifications in this catalog and production status of products are subject to change without notice. Prior to the purchase, please contact NEC TOKIN for updated product data.
- Please request for a specification sheet for detailed product data prior to the purchase.
- Before using the product in this catalog, please read "Precautions" and other safety precautions listed in the printed version catalog.

# Precautions

- Connect the red lead wire to the positive (+) terminal of the power supply.
- Carefully avoid electric shock since a high voltage is in use.
- Never apply excessive tension to a lead wire. Do not handle the product by picking up or moving the lead wire.
- Do not disassemble the case of the metal sealed type.
- Machining of the actuator element and replacement of the lead wire are prohibited.
- Do not handle the resin-coated type (AE series) with bare hands. Otherwise, the reliability of the element would be degraded.
- Do not wash resin-coated type (AE series) by organic solvent.
- Avoid excessive physical shock resulting from, for example, dropping. Otherwise, the internal piezoelectric ceramic element may be damaged.
- If the actuator is exposed to high temperature above 100°C or if it is used after long storage period (more than three months), it should be polarized by using the circuit configuration and conditions shown below.

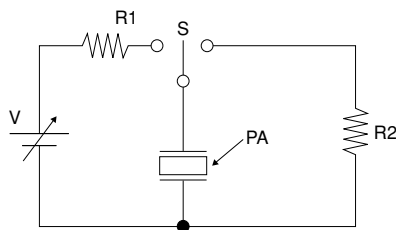

Protective resistor R1=1kΩ  
 Protective resistor R2=1kΩ  
 Polarizing conditions: DC voltage application  
 0V→150±0.2V (to be retained for 10 seconds) →0

- Do not apply voltage exceeding maximum rating voltage, or do not do rapid charging and discharging. These might lead to degradation of the reliability or mechanical fracture.
- Do not use the actuator in high concentration of highly inflammable gas. Otherwise, ignition may occur.
- Use the actuator so as not to cause bending, twisting or tension. Furthermore, align the center axis of displacement of the actuator with the center axis of the mechanical load.
- Drive the actuator so that the rising speed is more than three times as much as the resonance period in order to prevent the device from damaging by ringing.
- Store the resin-coated type (AE series) preferably in a dry atmosphere (desirably below 40% RH) at ordinary temperatures (− 5 to + 40°C). Avoid condensation on the product surface.
- Store actuators where there is no vibration.
- These products must be handled properly as industrial waste. When disposing, please contact your local waste disposal service.
- Piezo actuator is industrial wastes, make sure disposal method under the laws.



- All specifications in this catalog and production status of products are subject to change without notice. Prior to the purchase, please contact NEC TOKIN for updated product data.
- Please request for a specification sheet for detailed product data prior to the purchase.
- Before using the product in this catalog, please read "Precautions" and other safety precautions listed in the printed version catalog.



- All specifications in this catalog and production status of products are subject to change without notice. Prior to the purchase, please contact NEC TOKIN for updated product data.
- Please request for a specification sheet for detailed product data prior to the purchase.
- Before using the product in this catalog, please read "Precautions" and other safety precautions listed in the printed version catalog.



- All specifications in this catalog and production status of products are subject to change without notice. Prior to the purchase, please contact NEC TOKIN for updated product data.
- Please request for a specification sheet for detailed product data prior to the purchase.
- Before using the product in this catalog, please read "Precautions" and other safety precautions listed in the printed version catalog.



- All specifications in this catalog and production status of products are subject to change without notice. Prior to the purchase, please contact NEC TOKIN for updated product data.
- Please request for a specification sheet for detailed product data prior to the purchase.
- Before using the product in this catalog, please read "Precautions" and other safety precautions listed in the printed version catalog.

## When using our products, the following precautions should be taken.

- (1) Safety designing of an apparatus or a system allowing for failures of electronic components used in the system

In general, failures will occur in electronic components at a certain probability. NEC TOKIN makes every effort to improve the quality and reliability of electronic component products. However, it is impossible to completely eliminate the probability of failures. Therefore, when using NEC TOKIN's electronic component products, systems should be carefully designed to ensure redundancy in the event of an accident which would result in injury or death, fire, or social damage, to ensure the prevention of the spread of fire, and the prevention of faulty operation. (Please refer to precautions to be taken when using multilayer piezoelectric actuators for the details of failures.)

- (2) Quality level of various kinds of parts, and equipment in which the parts can be utilized  
Electronic components have a standard quality level unless otherwise specified.

NEC TOKIN classifies the level of quality of electronic component products into three levels, in order from a lower level, a standard quality level, a special quality level, and a custom quality level in which a customer individually specifies a quality assurance program. Each of the quality levels has recommended applications.

If a user wants to use the electronic parts having a standard quality level in applications other than the applications specified for the standard quality level, they should always consult a member of our company's sales staff before using the electronic parts.

Standard quality level	: Computers, office automation equipment, communications equipment, measuring instruments, AV equipment, household electrical appliances, machine tools, personal equipment, industrial robots
Special quality level	: Transportation equipment (automobiles, railways, shipping, or the like), traffic signals, disaster prevention/crime prevention systems, a variety of safety devices, and medical equipment which is not directly intended for life-support purposes
Custom quality level	: Equipment for airplanes, aerospace equipment, nuclear power control systems, and medical equipment, apparatus or system for life-support purposes

Unless otherwise shown, the quality level of NEC TOKIN's electronic component products included in documents such as catalogues, data sheets or data books is the standard quality level.

- (3) This manual is subject to change without notice.

The contents of this manual are based on data which is correct as of June 2011, and they may be changed without notice. If our products are used for mass-production design, please consult with a member of our company's sales staff by way of precaution.

- (4) Reprinting and copying of this manual without prior written permission from NEC TOKIN Corporation are not permitted.

- (5) Industrial property problems

In the event any problems associated with industrial property of a third party arising as a result of the use of our products, NEC TOKIN assumes no responsibility for problems other than problems directly associated with the constitution and manufacturing method of the products.

- (6) Should any of these products come under the category of strategic goods or services (according to Japan's foreign trade and foreign exchange regulations), the sender must obtain an export license from the Japanese Government before said products can be exported outside Japan.



- All specifications in this catalog and production status of products are subject to change without notice. Prior to the purchase, please contact NEC TOKIN for updated product data.
- Please request for a specification sheet for detailed product data prior to the purchase.
- Before using the product in this catalog, please read "Precautions" and other safety precautions listed in the printed version catalog.