

3.0-5.5V Input	0.9-3.3V Outputs	10 Amp Current	Non Isolated	SIP Single In-Line Package
---------------------------	-----------------------------	---------------------------	-------------------------	---------------------------------------

The NiQor™ SIP DC/DC converter is a non-isolated buck regulator, which employs synchronous rectification to achieve extremely high conversion efficiency. The NiQor family of converters are used predominately in DPA systems using a front end DC/DC high power brick (48Vin to low voltage bus). The non-isolated NiQor converters are then used at the point of load to create the low voltage outputs required by the design. The wide trim module can be programmed over a wide range of output voltages through the use of a single external resistor. RoHS 5/6 compliant (see page 17).

NiQor

Non-Isolated



NQ04T33VKA10 wide trim module

Operational Features

- Ultra high efficiency, up to 95% at full rated load
- Delivers up to 10 Amps of output current with minimal derating - no heatsink required
- Input Voltage Range : 3.0 - 5.5V
- Programmable output voltages from 0.85 - 3.6V
- On-board input and output filter capacitor
- No minimum load requirement means no preload resistors required

Mechanical Features

- Industry standard SIP pin-out configuration
- Industry standard size: 2.0" x 0.55" x 0.29" (50.8 x 14 x 7.3mm)
- Total weight: 0.30 oz. (9.4 g)
- Open frame construction maximizes air flow cooling
- Available in both vertical and horizontal mounting

Control Features

- On/Off control
- Output voltage trim (industry standard) permits custom voltages and voltage margining
- Remote Sense (standard option)

Protection Features

- Input under-voltage lockout disables converter at low input voltage conditions
- Temperature compensated over-current shutdown protects converter from excessive load current or short circuits
- Output over-voltage protection protects load from damaging voltages (>4.4V)
- Thermal shutdown protects converter from abnormal environmental conditions

Safety Features

- UL/cUL 60950 recognized (US & Canada)
- TUV certified to EN60950
- Meets 72/23/EEC and 93/68/EEC directives which facilitates CE Marking in user's end product
- Board and plastic components meet UL94V-0 flammability requirements

MECHANICAL DIAGRAM

Vertical Mount

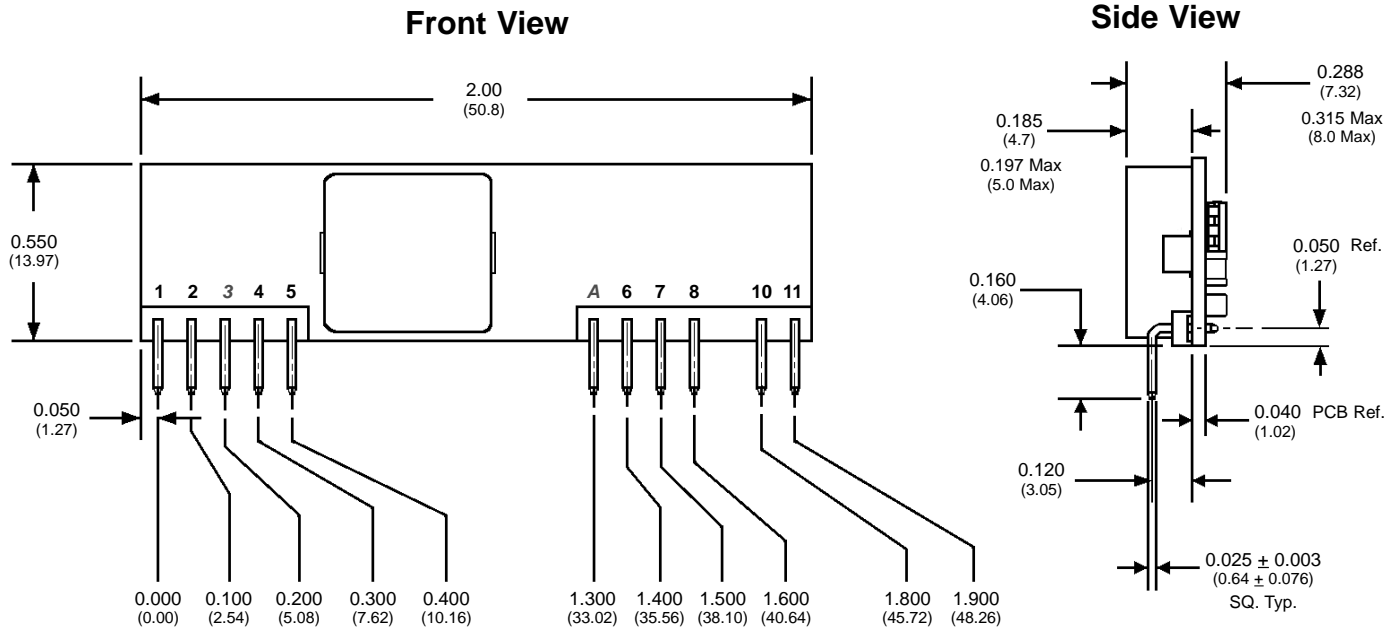

NOTES

- 1) All pins are 0.025" (0.64mm) +/- 0.003 (0.076mm) square.
- 2) All Pins: Material - Copper Alloy
Finish - Tin over Nickel plate
- 3) Vertical, horizontal, vertical with reverse pins and surface mount options (future) available.
- 4) Undimensioned components are shown for visual reference only.
- 6) All dimensions in inches (mm)
Tolerances: x.xx +/-0.02 in. (x.x +/-0.5mm)
x.xxx +/-0.010 in. (x.xx +/-0.25mm)
- 7) Weight: 0.30 oz. (9.4 g) typical
- 8) Workmanship: Meets or exceeds IPC-A-610C Class II

Pin Connection Notes:

1. Pin 10 - for fixed resistors, connect between Trim and Common (Ground).
2. Pin 11 - see section on [Remote ON/OFF](#) pin for description of enable logic options.

PIN DESIGNATIONS

Pin No.	Name	Function
1	Vout(+)	Positive output voltage
2	Vout(+)	Positive output voltage
3	<i>SENSE(+)</i>	<i>Positive remote sense</i>
4	Vout(+)	Positive output voltage
5	Common	
A	<i>N/C</i>	<i>No Connection</i>
6	Common	
7	Vin(+)	Positive input voltage
8	Vin(+)	Positive input voltage
10	TRIM ¹	Output voltage trim (trim-up only)
11	ON/OFF ²	LOGIC input to turn the converter on and off.

Pins in Italics Shaded text are Optional

MECHANICAL DIAGRAM

Horizontal Mount

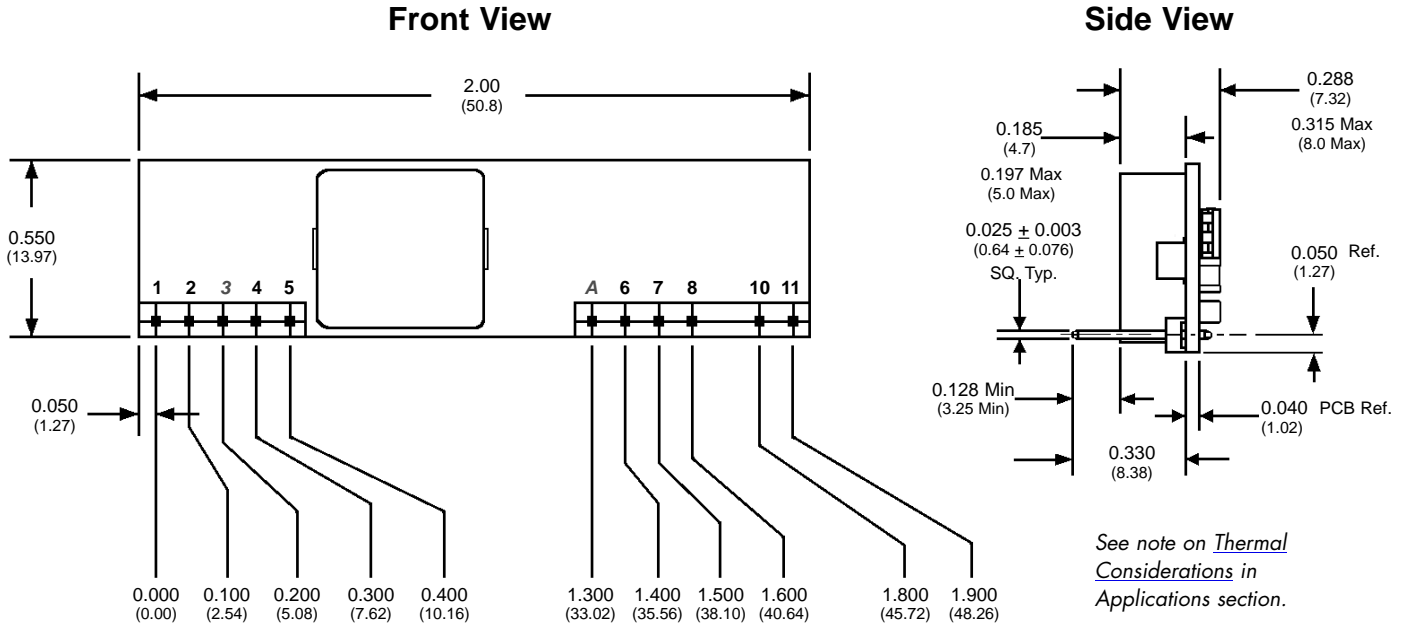

Vertical Mount Reversed Pins

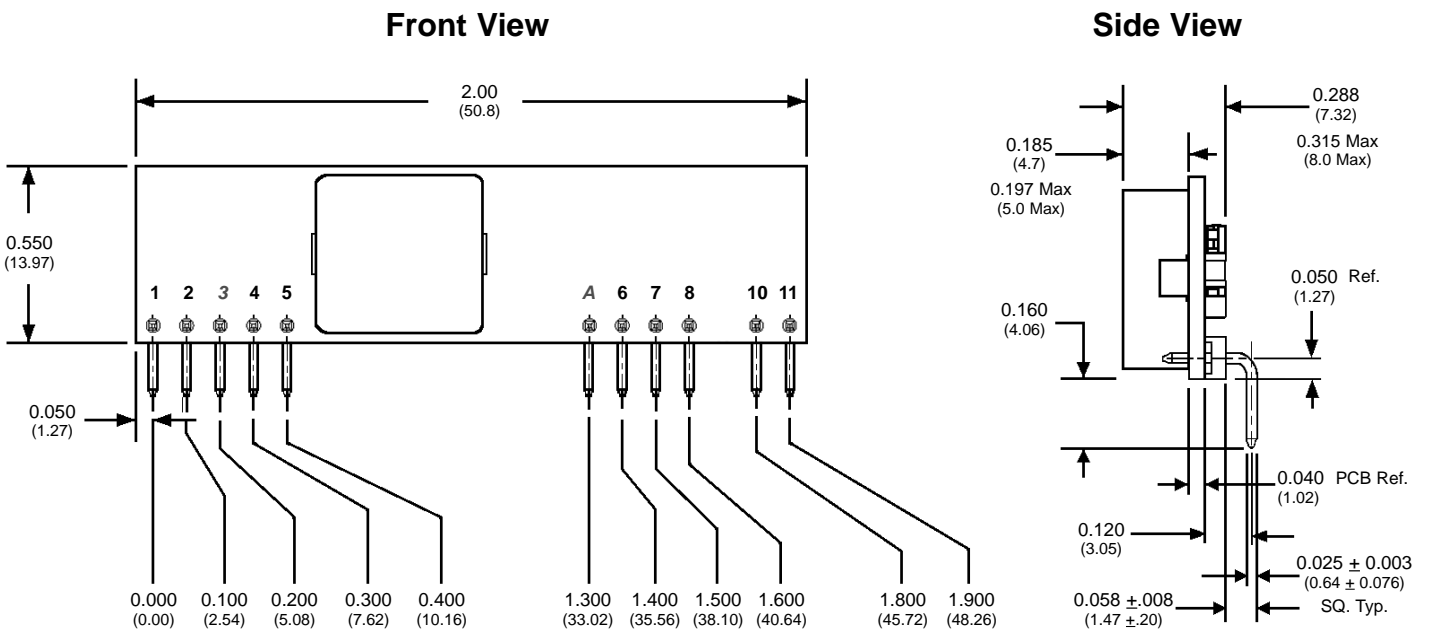



Technical Specification

Input: 3.0 - 5.5V
Outputs: 0.9 - 3.3V
Current: 10A
Package: SIP

ELECTRICAL CHARACTERISTICS - NQ04T33VKA10 Series

V_{in} =3.3Vdc and 5.0Vdc except 3.3V_{out} units where V_{in} =5.0V; T_A =25°C, airflow rate=300 LFM unless otherwise noted; full operating temperature range is -40°C to +105°C ambient temp with appropriate power derating. Specifications subject to change without notice.

Parameter	Setpoint	Min.	Typ.	Max.	Units	Notes & Conditions
ABSOLUTE MAXIMUM RATINGS						
Input Voltage						
Non-Operating	All			6.0	V	Continuous
Operating	All	3.0		5.5	V	Continuous
Operating Transient Protection	All			7.0	V	100ms transient
Operating Temperature	All	-40		105	°C	
Storage Temperature	All	-55		125	°C	
Voltage at ON/OFF input pin (N, O options)	All	-3		6.5	V	Negative/Open logic
Voltage at ON/OFF input pin (P option)	All	-0.5		$V_{in} + 0.3$	V	Positive/Open logic
INPUT CHARACTERISTICS						
Operating Input Voltage Range ¹	0.9-2.5V	3.0	3.3-5.0	5.5	V	See notes on Page 6
"	3.3V	4.5	5.0	5.5	V	"
Input Under-Voltage Lockout ¹						
Turn-On Voltage Threshold	0.9-2.5V	1.9	2.4	2.85	V	
Turn-On Voltage Threshold	3.3V	4.1	4.3	4.5	V	
Turn-Off Voltage Threshold	0.9-2.5V	1.9	2.3	2.85	V	
Turn-Off Voltage Threshold	3.3V	3.5	3.7	4.0	V	
Maximum Input Current (3.0Vin\4.5Vin)	0.9V			3.9\2.6	A	100% Load, full temp range, for all voltages
"	1.0V			4.3\2.9	A	"
"	1.2V			5.0\3.4	A	"
"	1.5V			5.9\4.0	A	"
"	1.8V			7.0\4.7	A	"
"	2.5V			9.3\6.3	A	"
"	3.3V			8.1	A	3.3V _{out} at 4.5Vin only
No-Load Input Current (3.3Vin)	0.9-2.5V		80	105	mA	
No-Load Input Current (5.0Vin)	0.9-2.5V		100	130	mA	
"	3.3V		80	105	mA	
Disabled Input Current	0.9-2.5V		15	25	mA	
"	3.3V		10	20	mA	
Inrush Current Transient Rating	All			0.1	A ² s	
Response to Input Transient (3.3Vin)	0.9V		130		mV/V	50mV/μs input transient (all)
"	2.5V		250		mV/V	"
Response to Input Transient (5.0 Vin)	0.9V		75		mV/V	
"	3.3V		200		mV/V	
Input Reflected-Ripple Current (3.3Vin)	0.9-1.8V		134		mA	Peak to peak through 1μH inductor
"	2.5V		84		mA	"
Input Reflected-Ripple Current (5.0Vin)	0.9, 1.0V		109		mA	Peak to peak through 1μH inductor
"	1.2, 3.3V		125		mA	"
"	1.5-2.5V		147		mA	"
Input Terminal Ripple Current (3.3Vin)	0.9-1.8V		2.0		A	RMS; 200μF/50mΩ input cap.
"	2.5V		1.4		A	"
Input Terminal Ripple Current (5.0Vin)	0.9, 1.0V		1.7		A	RMS 200μF/50mΩ input cap.
"	1.2, 1.5V		2.0		A	"
"	1.8, 2.5V		2.3		A	"
"	3.3V		2.0		A	"
Recommended Input Fuse	All			20	A	Fast blow external fuse recommended
Input Filter Capacitor Value	All		40		μF	Internal ceramic
Input Ripple Voltage (3.3Vin)	0.9, 2.5V		84		mV	RMS, full load, 200μF/50mΩ input cap.
"	1.0-1.8V		94		mV	"
Input Ripple Voltage (5.0Vin)	0.9-1.2V		75		mV	RMS, full load, 200μF/50mΩ input cap.
"	1.5, 1.8V		88		mV	"
"	2.5, 3.3V		94		mV	"
Recommended External Input Capacitance ²	All		200		μF	Net 50mΩ ESR

ELECTRICAL CHARACTERISTICS (continued) - NQ04T33VKA10 Series

Parameter	Setpoint	Min.	Typ.	Max.	Units	Notes & Conditions
OUTPUT CHARACTERISTICS						
Output Voltage Set Point ⁶ (50% load)	0.9V	0.884	0.900	0.917	V	See trim equation
"	1.0V	0.984	1.000	1.019	V	"
"	1.2V	1.181	1.200	1.221	V	"
"	1.5V	1.477	1.500	1.526	V	"
"	1.8V	1.773	1.800	1.831	V	"
"	2.5V	2.461	2.500	2.543	V	"
"	3.3V	3.242	3.300	3.358	V	Vin range 4.5V - 5.5V
Output Voltage Regulation						
Over Line	All	-0.2	±0.1	0.2	%	
Over Load	0.9V		±0.5		%	With sense pin
"	3.3V		±0.2		%	"
Over Temperature	All	-2.3		1.2	%	
Total Output Voltage Range	0.9V	0.859		0.940	V	With sense pin, over sample, line, load, temp & life (all)
"	1.0V	0.957		1.044	V	"
"	1.2V	1.150		1.250	V	"
"	1.5V	1.438		1.563	V	"
"	1.8V	1.727		1.875	V	"
"	2.5V	2.397		2.605	V	"
"	3.3V	3.152		3.444	V	"
Output Voltage Ripple & Noise (3.3Vin)	All		15\6	35\12		Peak to peak\RMS; full load, 20MHz bandwidth
Output Voltage Ripple & Noise (5.0Vin)	All		25\9	60\20	mV	Figures 26 - 28
Operating Output Current Range	All	0		10	A	
Output DC Over-Current Shutdown ³	All	11	18	25	A	
Maximum Output Capacitance ^{2,4}	All			4,000	µF	Derate startup load current per Figure 25
DYNAMIC CHARACTERISTICS						
Input Voltage Ripple Rejection (3.3Vin)	0.9V		51		dB	120 Hz
"	2.5V		37		dB	"
Input Voltage Ripple Rejection (5.0Vin)	0.9V		56		dB	120 Hz
"	3.3V		39		dB	"
Output Voltage during Load Current Transient						
For a Step Change $I_{out}=0.1A/\mu s$ (3.3Vin\5Vin)	All		90\70		mV	10µF, Figures 15 & 17
For a Step Change $I_{out}=3A/\mu s$ (3.3Vin\5Vin)	All		70\60		mV	470µF, Figures 16 & 18
Settling Time (3.3Vin\5Vin)	All		140\40		µs	To within 1.5% Vout nom., Figures 15 - 18
Turn-On Transient						Load current & capacitance per Figure 25
Turn-On Time	All	5.5	6.8	8.5	ms	Enable to Vout=100% nom., Figures 19 - 22
Start-Up Delay Time	0.9V	2.9	4.0	5.9	ms	Enable to 10%, Figure 23
"	3.3V	1.5	2.5	4.3	ms	"
Start-Up Rise Time	0.9V	1.7	2.5	3.9	ms	10% to 90%, Figure 24
"	3.3V	2.6	3.9	5.7	ms	"
Output Voltage Overshoot	All			0	%	Resistive load, up to 4,000 µF
EFFICIENCY						
100% Load (3.3Vin\5Vin)	0.9V		86\85		%	Figures 1 - 4
"	1.0V		87\86		%	"
"	1.2V		88\87.5		%	"
"	1.5V		91\89		%	"
"	1.8V		92.5\91		%	"
"	2.5V		94.5\93		%	"
"	3.3V		94.5		%	"

ELECTRICAL CHARACTERISTICS (continued) - NQ04T33VKA10 Series

Parameter	Module	Min.	Typ.	Max.	Units	Notes & Conditions
EFFICIENCY (cont.)						
50% Load (3.3V _{in} \5V _{in})	0.9V		87.5\85		%	Figures 1 - 4
"	1.0V		88\86		%	"
"	1.2V		90.5\87.5		%	"
"	1.5V		92\89		%	"
"	1.8V		93\91		%	"
"	2.5V		95\93		%	"
"	3.3V		95		%	"
TEMP. LIMITS FOR POWER DERATING						
Semiconductor Junction Temperature ⁵	All			125	°C	Package rated to 150°C; Figures 5 - 14
Board Temperature ⁵	All			125	°C	UL rated max operating temp 130°C
FEATURE CHARACTERISTICS						
Switching Frequency	All	265	300	330	kHz	May decrease by up to 30 kHz at -40°C
Negative Logic (O logic) ON/OFF Control						Figure A
Off-State Voltage	All	1.5		6.5	V	
On-State Voltage	All	-3		0.6	V	
Input Resistance	All		20		kΩ	
Positive Logic (P) ON/OFF Control						Open collector/drain input; Figure A
Logic Low Voltage Range	All	-0.2		1	V	
Logic High Voltage Range (internal pullup)	All	2.2		V _{in}	V	
Logic Low sink current	All	300	V _{in} /10K	550	μA	
Logic High sink current (leakage)	All			10	μA	
Output Voltage Trim Range ^{1,6,8}	All	0.85		3.6	V	Measured V _{out+} to common pins; Table 1
Output Voltage Remote Sense Range ^{1,7,8}	All			+10	%	Measured V _{out+} to common pins
Output Over-Voltage Protection ⁸	All	3.75	4.05	4.35	V	Over full temp range
Over-Temperature Shutdown	All		120		°C	Average PCB Temperature
Over-Temperature Shutdown Restart Hysteresis	All		5		°C	
RELIABILITY CHARACTERISTICS						
Calculated MTBF (Telcordia)	All		10.1		10 ⁶ Hrs.	TR-NWT-000332; 15A load, 200LFM, 40°C T _a
Calculated MTBF (MIL-217)	All		6.6		10 ⁶ Hrs.	MIL-HDBK-217F; 15A load, 200LFM, 40°C T _a
Field Demonstrated MTBF	All				10 ⁶ Hrs.	See our website for details

Note 1: Maintain a minimum of 0.4V headroom between input and output voltage to meet performance specifications.

Note 2: Tantalum or similar with additional ceramic as needed to reduce ripple current in external input capacitors. See Figure 26. When using more than 1000μF of output capacitance, input filter inductor should be reduced to ≤0.3μH or input capacitance should be increased to match output capacitance. Consult factory for more demanding applications. Also refer to Application Considerations section of this datasheet.

Note 3: The over-current shutdown threshold for a short over-current pulse can be as high as 50A when trimming up a wide trim unit above 1.2V.

Note 4: When trimming a 0.9V unit to less than 0.88V with more than 1000μF of output capacitance, consult factory for trim circuit recommendations. This also applies to trimming a 1.0V unit below 0.95V.

Note 5: Power derating curves are measured using an evaluation board consisting of 6 layers of 2 ounce copper.

Note 6: Wide trim option unit has a setpoint of 0.753V and a trim range of 0.85V-3.6V.

Note 7: In remote sense applications, when trimming down, the trim-down resistor should be connected to the sense pin for more accurate trimming results.

Note 8: User should allow sufficient transient response headroom between the module's local output and the minimum OVP threshold.



Technical Specification

Input: 3.0 - 5.5V
Outputs: 0.9 - 3.3V
Current: 10A
Package: SIP

STANDARDS COMPLIANCE

Parameter	Notes
STANDARDS COMPLIANCE	
UL/cUL 60950	File # E194341
EN60950	Certified by TUV
72/23/EEC	
93/68/EEC	
Needle Flame Test (IEC 695-2-2)	test on entire assembly; board & plastic components UL94V-0 compliant
IEC 61000-4-2	ESD test, 8kV - NP, 15kV air - NP (Normal Performance)
GR-1089-CORE	Section 7 - electrical safety, Section 9 - bonding/grounding
Telcordia (Bellcore) GR-513	

- An external input fuse must always be used to meet these safety requirements. Contact SynQor for official safety certificates on new releases or download from the [SynQor website](#).

QUALIFICATION TESTING

Parameter	# Units	Test Conditions
QUALIFICATION TESTING		
Life Test	42	95% rated V_{in} and load, units at derating point, 1000 hours
Vibration	5	10-55Hz sweep, 0.060" total excursion, 1 min./sweep, 120 sweeps for 3 axis
Mechanical Shock	5	100g minimum, 2 drops in x and y axis, 1 drop in z axis
Temperature Cycling	10	-40°C to 100°C, unit temp. ramp 15°C/min., 500 cycles
Power/Thermal Cycling	5	Toperating = min to max, V_{in} = min to max, full load, 100 cycles
Design Marginality	5	T_{min} -10°C to T_{max} +10°C, 5°C steps, V_{in} = min to max, 0-105% load
Humidity	5	85°C, 85% RH, 1000 hours, continuous V_{in} applied except 5min./day
Solderability	15 pins	MIL-STD-883, method 2003

- Extensive characterization testing of all SynQor products and manufacturing processes is performed to ensure that we supply robust, reliable product. Contact factory for official product family qualification document.

OPTIONS

SynQor provides various options for Packaging, Enable Logic, Pin Length and Feature Set for this family of DC/DC converters. Please consult the [last page](#) of this specification sheet for information on available options.

PATENTS

SynQor is protected under various patents, including but not limited to U.S. Patent numbers: 5,999,417; 6,222,742 B1; 6,594,159 B2; 6,545,890 B2.

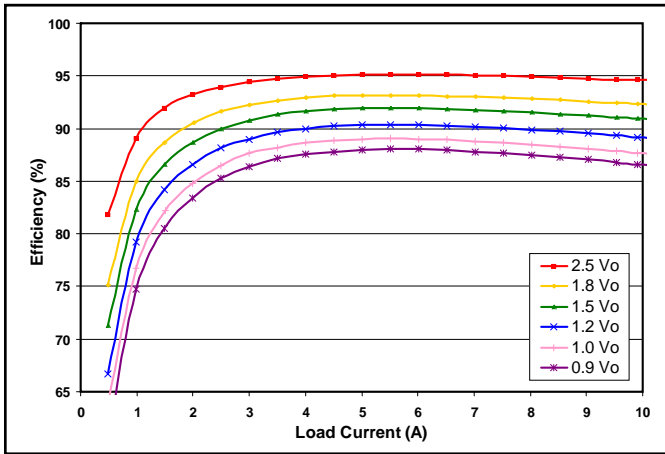

Figure 1: Efficiency at 3.3Vin and nominal output voltage vs. load current for all modules at 25°C.

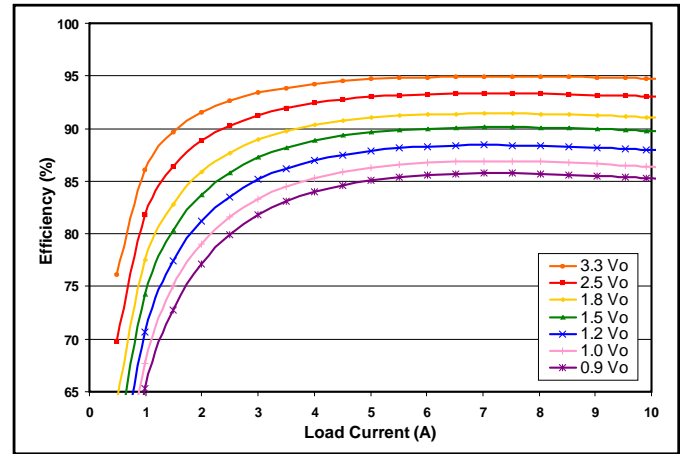

Figure 2: Efficiency at 5.0Vin and nominal output voltage vs. load current for all modules at 25°C.

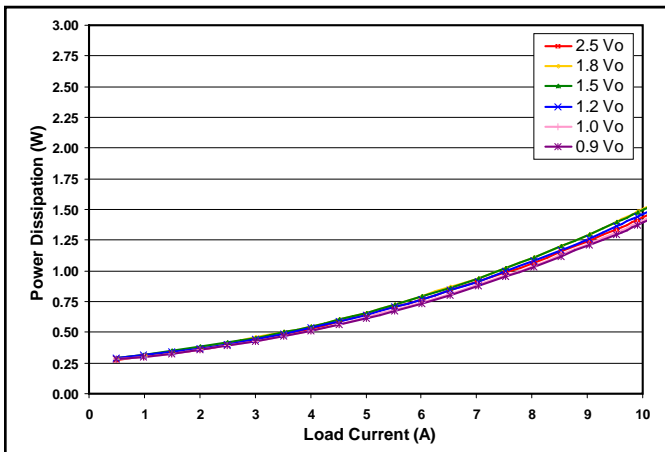

Figure 3: Power dissipation at 3.3Vin and nominal output voltage vs. load current for all modules at 25°C.

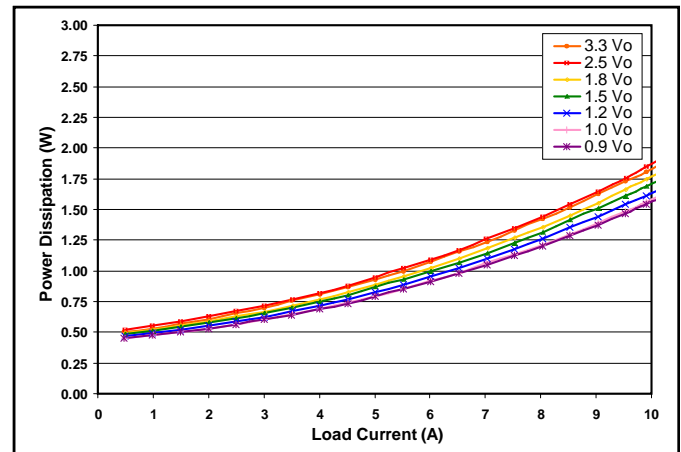

Figure 4: Power dissipation at 5.0Vin and nominal output voltage vs. load current for all modules at 25°C.

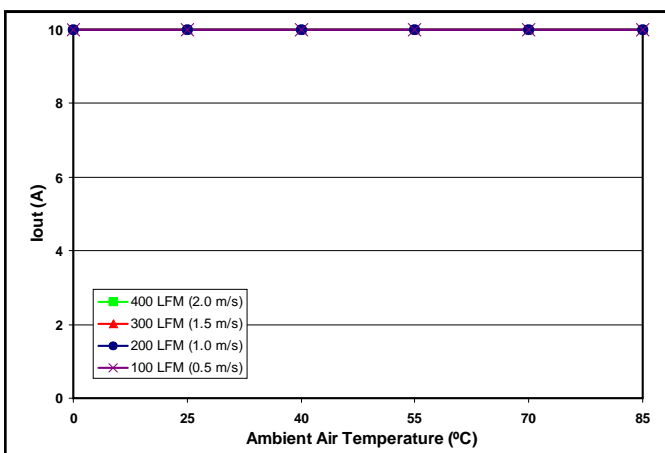

Figure 5: Maximum output power derating curves vs. ambient air temp for 0.9Vo to 1.8Vo units at 3.3Vin. Airflow rates of 100 - 400 LFM with air flowing across the converter from pin 11 to pin 1 (vert mount).

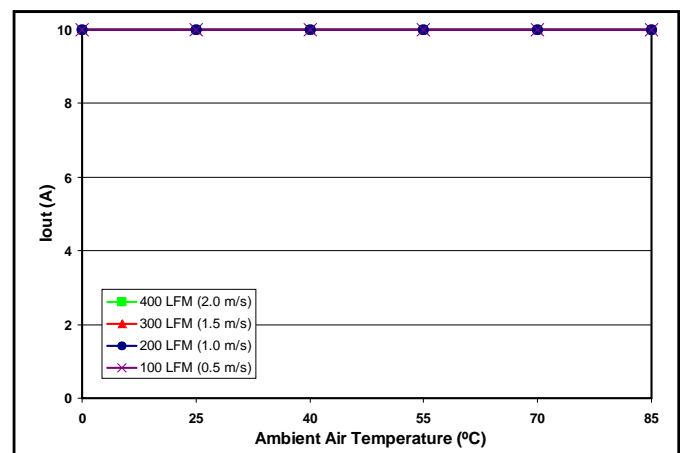

Figure 6: Maximum output power derating curves vs. ambient air temp for 0.9Vo to 1.8Vo units at 5.0Vin. Airflow rates of 100 - 400 LFM with air flowing across the converter from pin 11 to pin 1 (vert mount).

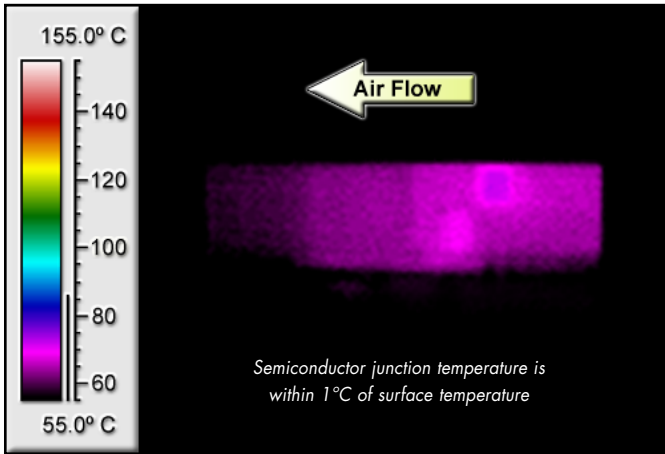

Figure 7: Thermal plot of 0.9Vo to 1.8Vo converters at 3.3Vin with 10 amp load current and 55°C air flowing at the rate of 200 LFM. Air is flowing across the converter from pin 11 to pin 1 (vertical mount).

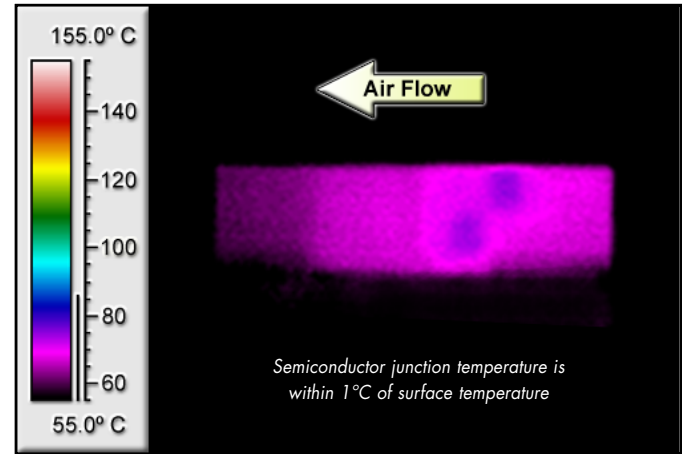

Figure 8: Thermal plot of 0.9Vo to 1.8Vo converters at 5.0Vin with 10 amp load current and 55°C air flowing at the rate of 200 LFM. Air is flowing across the converter from pin 11 to pin 1 (vertical mount).

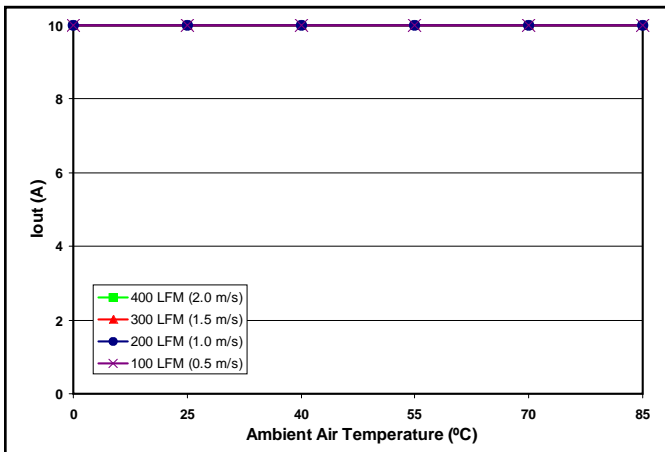

Figure 9: Maximum output power derating curves vs. ambient air temperature for 2.5Vout unit at 3.3Vin. Airflow rates of 100 - 400 LFM with air flowing across the converter from pin 11 to pin 1 (vert mount).

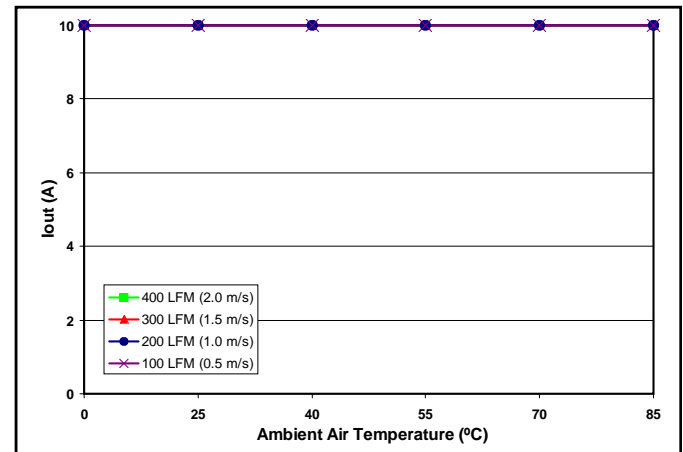

Figure 10: Maximum output power derating curves vs. ambient air temperature for 2.5Vout unit at 5.0Vin. Airflow rates of 100 - 400 LFM with air flowing across the converter from pin 11 to pin 1 (vert mount).

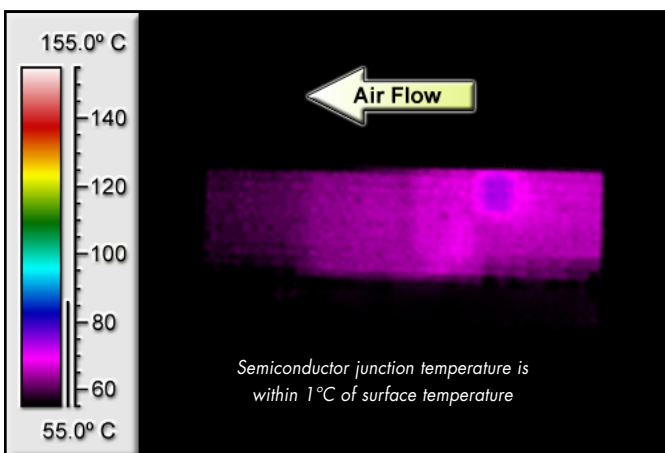

Figure 11: Thermal plot of 2.5Vout converter at 3.3Vin with 10 amp load current and 55°C air flowing at the rate of 200 LFM. Air is flowing across the converter from pin 11 to pin 1 (vertical mount).

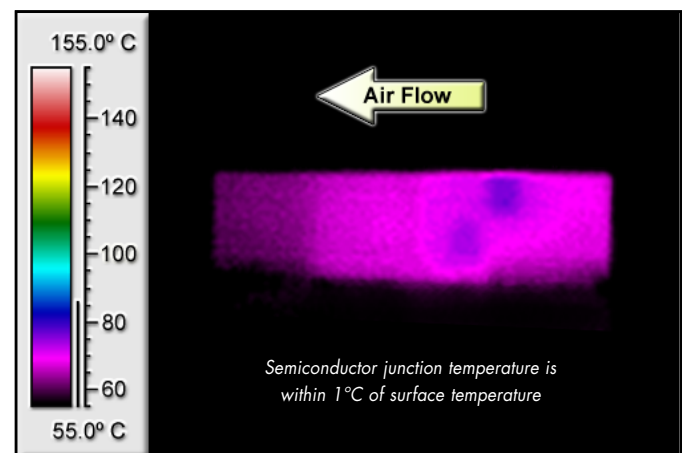

Figure 12: Thermal plot of 2.5Vout converter at 5.0Vin with 10 amp load current and 55°C air flowing at the rate of 200 LFM. Air is flowing across the converter from pin 11 to pin 1 (vertical mount).

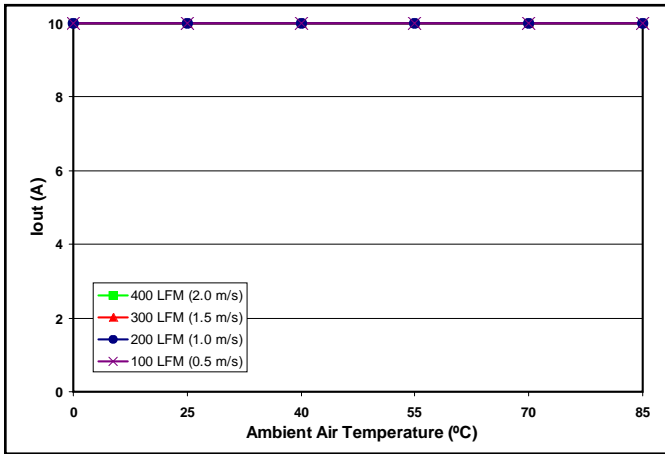

Figure 13: Maximum output power derating curves vs. ambient air temperature for 3.3Vout unit at 5.0Vin. Airflow rates of 100 - 400 LFM with air flowing across the converter from pin 11 to pin 1 (vert mount).

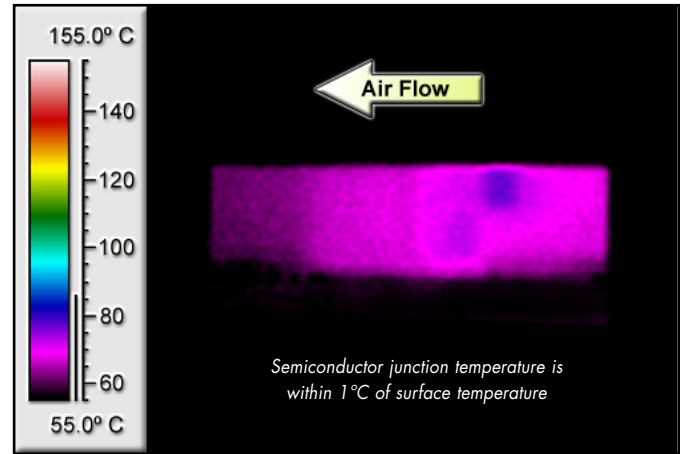

Figure 14: Thermal plot of 3.3Vout converter at 5.0Vin with 15 amp load current and 55°C air flowing at the rate of 200 LFM. Air is flowing across the converter from pin 11 to pin 1 (vertical mount).

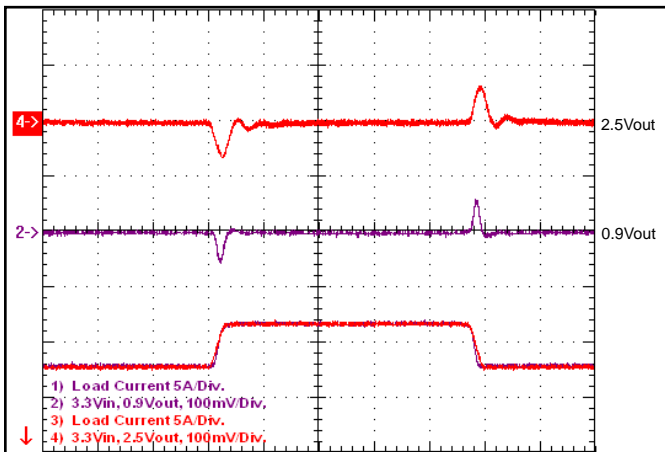

Figure 15: Output voltage response at 3.3Vin to step-change in load current (40% of Iout max; di/dt=0.1A/μs). Load cap: 15μF, 100mΩ ESR tantalum and 10μF ceramic. Top: Vout (100mV/div), Bottom: Iout (5A/div).

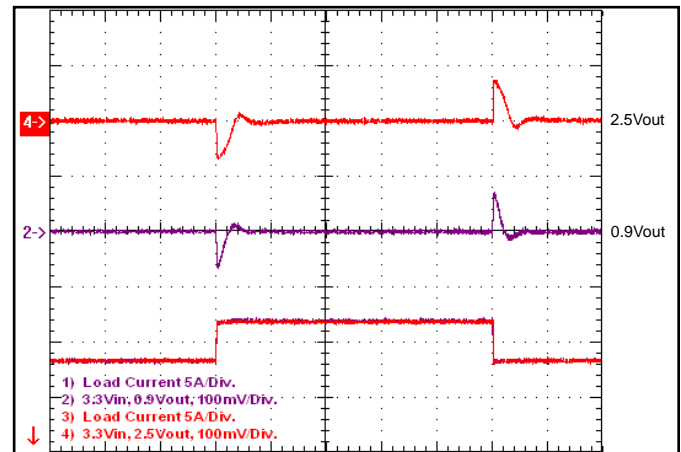

Figure 16: Output voltage response at 3.3Vin to step-change in load current (40% of Iout max; di/dt=3A/μs). Load cap: 470μF, 25mΩ ESR tantalum and 10μF ceramic. Top: Vout (100mV/div), Bottom: Iout (5A/div).

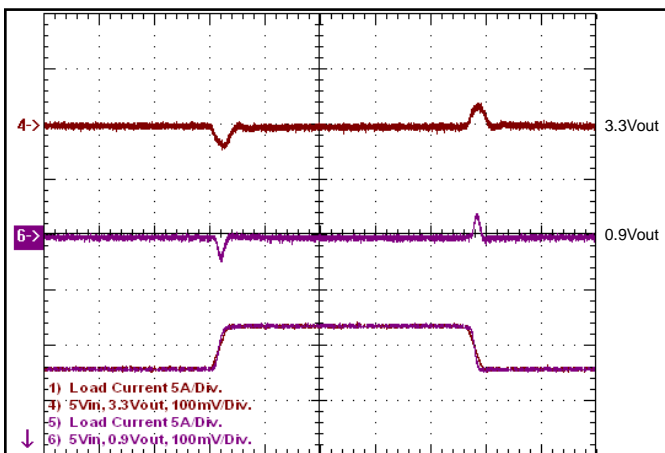

Figure 17: Output voltage response at 5.0Vin to step-change in load current (40% of Iout max; di/dt=0.1A/μs). Load cap: 15μF, 100mΩ ESR tantalum and 10μF ceramic. Top: Vout (100mV/div), Bottom: Iout (5A/div).

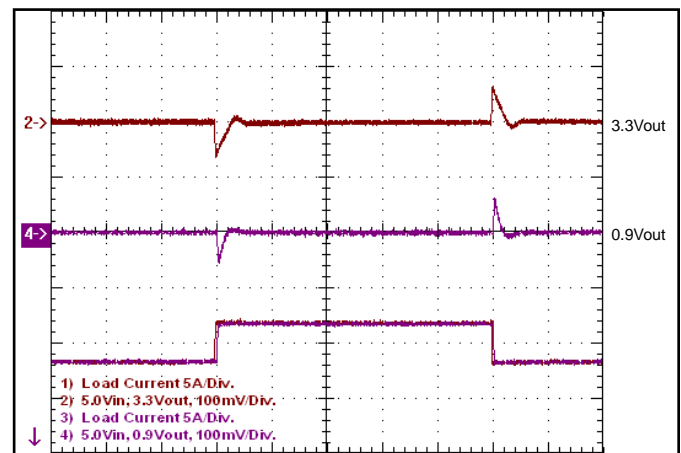

Figure 18: Output voltage response at 5.0Vin to step-change in load current (40% of Iout max; di/dt=3A/μs). Load cap: 470μF, 25mΩ ESR tantalum and 10μF ceramic. Top: Vout (100mV/div), Bottom: Iout (5A/div).

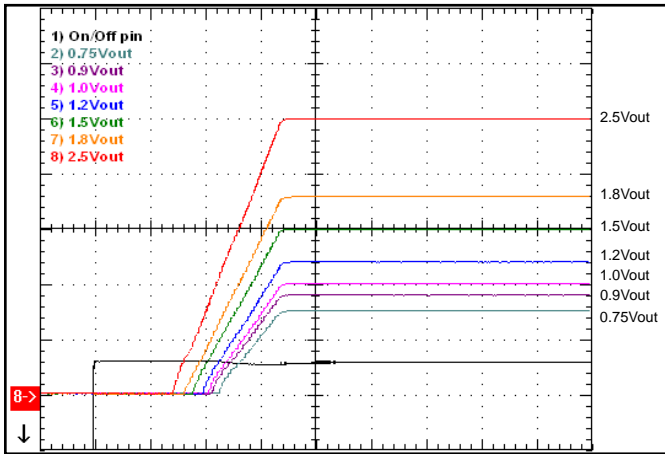

Figure 19: Turn-on transient at 3.3V_{in} and full load (resistive load) (2ms/div). Ch 1: ON/OFF input (2V/div). Ch 2-8: V_{out} (500mV/div)

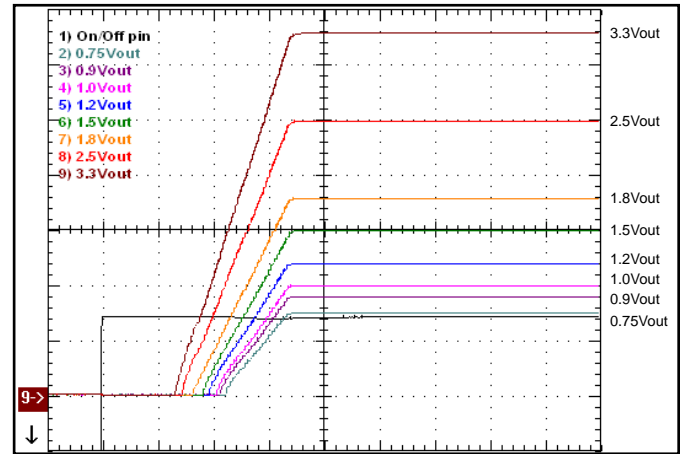

Figure 20: Turn-on transient at 5.0V_{in} and full load (resistive load) (2ms/div). Ch 1: ON/OFF input (2V/div). Ch 2-8: V_{out} (500mV/div)

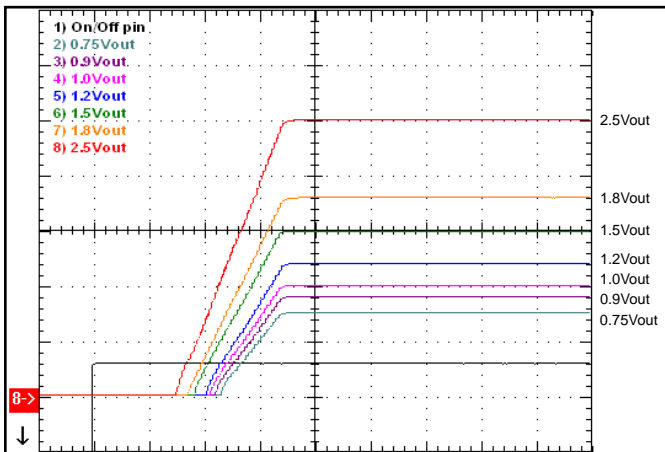

Figure 21: Turn-on transient at 3.3V_{in} and zero load (2ms/div). Ch 1: ON/OFF input (2V/div). Ch 2-8: V_{out} (500mV/div)

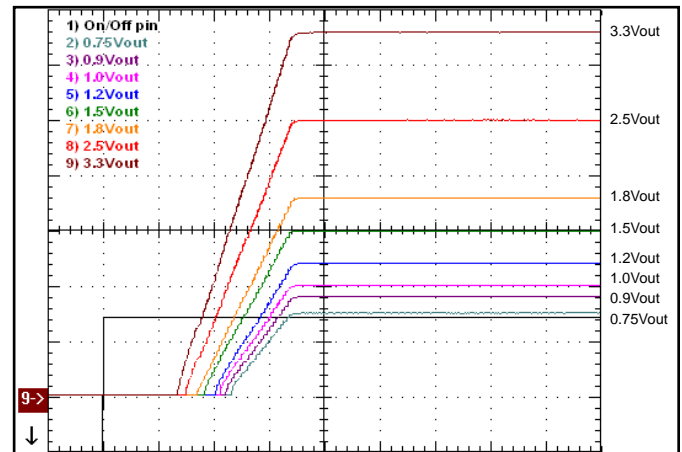

Figure 22: Turn-on transient at 5.0V_{in} and zero load (2ms/div). Ch 1: ON/OFF input (2V/div). Ch 2-8: V_{out} (500mV/div)

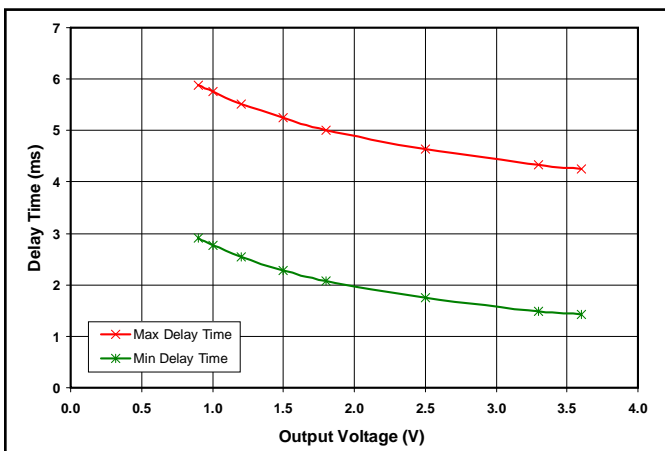

Figure 23: Minimum and Maximum Startup Delay Time (enable to 10%) over temperature versus output voltage (includes trimming).

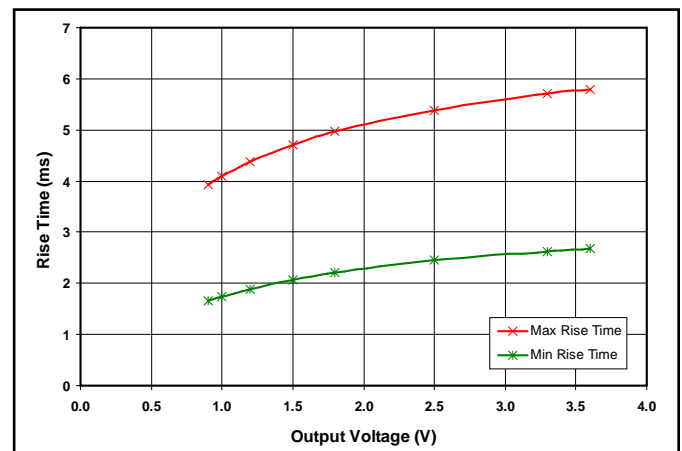

Figure 24: Minimum and Maximum Startup Rise Time (10% to 90%) over temperature versus output voltage (includes trimming).

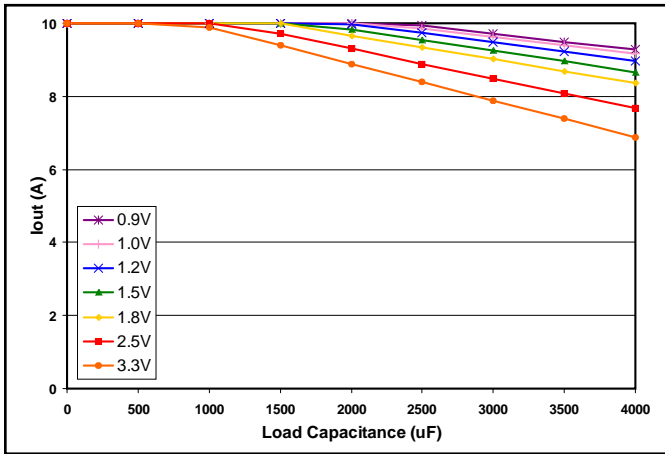

Figure 25: Maximum Startup Load Current versus Load Capacitance. Derate the load during startup according to this figure to avoid the possibility of over-current shutdown.

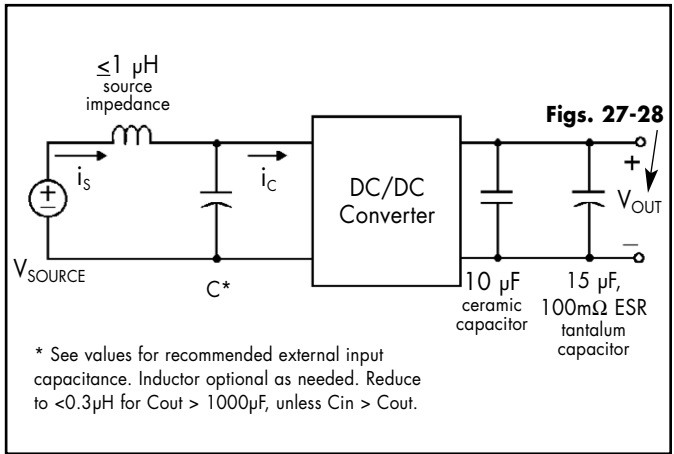

Figure 26: Test set-up diagram showing measurement points for Output Voltage Ripple (Figs 27-28).

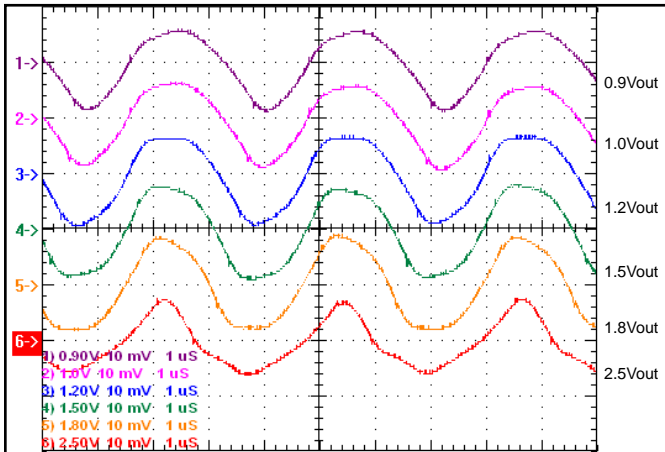

Figure 27: Output Voltage Ripple at 3.3V input voltage and rated load current (10 mV/div). Load capacitance: 10 μ F ceramic capacitor and 15 μ F tantalum capacitor. Bandwidth: 20 MHz. See Figure 26.

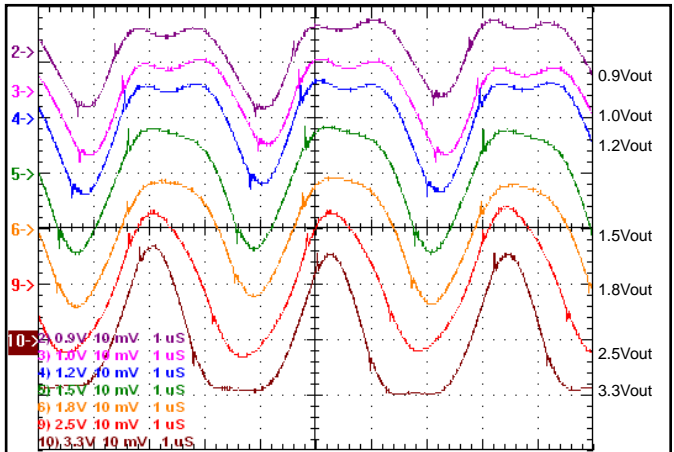

Figure 28: Output Voltage Ripple at 5.0V input voltage and rated load current (10 mV/div). Load capacitance: 10 μ F ceramic capacitor and 15 μ F tantalum capacitor. Bandwidth: 20 MHz. See Figure 26.

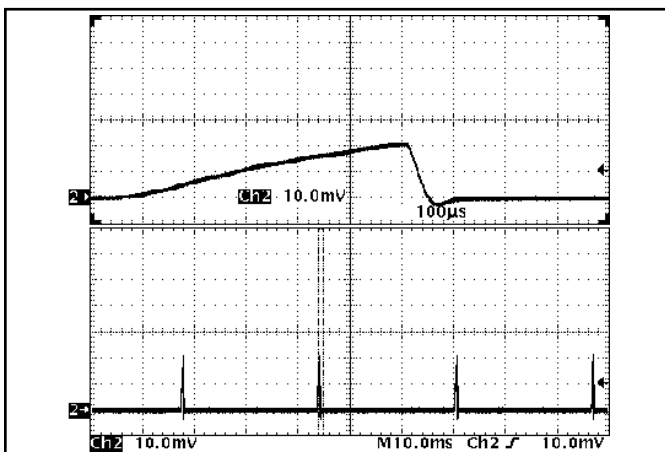

Figure 29: Load current (10A/div) as a function of time when a 3.3V_{in}, 0.9V_o unit attempts to turn on into a 10 m Ω short circuit. Top trace (100 μ s/div) is an expansion of the on-time portion of the bottom trace.

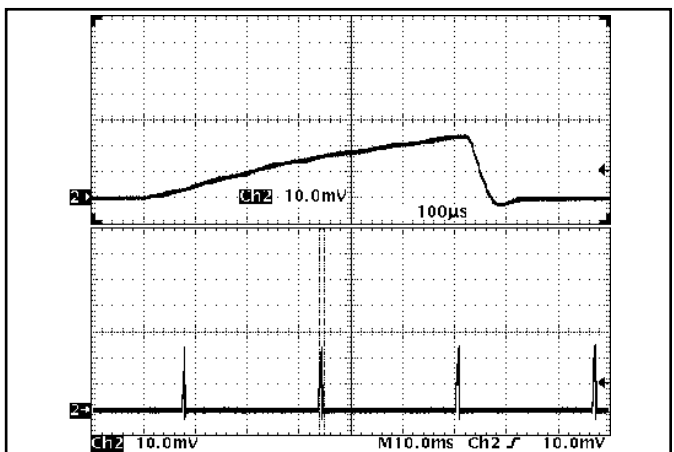

Figure 30: Load current (10A/div) as a function of time when a 5.0V_{in}, 0.9V_o unit attempts to turn on into a 10 m Ω short circuit. Top trace (100 μ s/div) is an expansion of the on-time portion of the bottom trace.

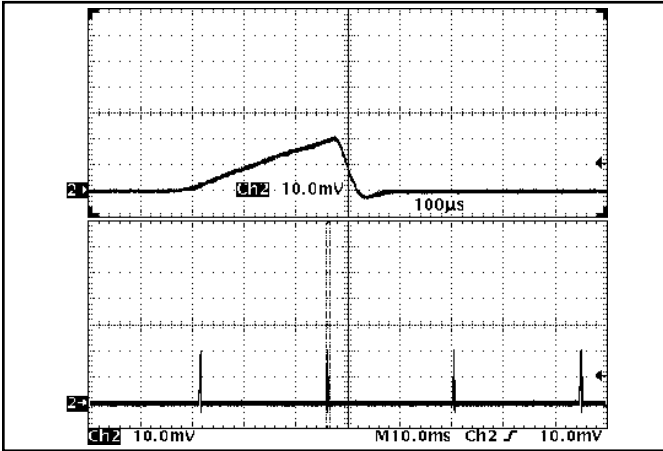

Figure 31: Load current (10A/div) as a function of time when a 3.3Vin, 2.5Vo unit attempts to turn on into a 10 mΩ short circuit. Top trace (100μs/div) is an expansion of the on-time portion of the bottom trace.

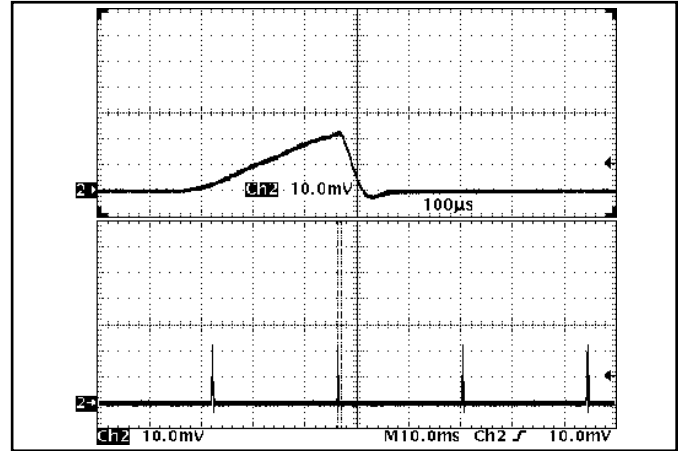

Figure 32: Load current (10A/div) as a function of time when a 5.0Vin, 3.3Vo unit attempts to turn on into a 10 mΩ short circuit. Top trace (100μs/div) is an expansion of the on-time portion of the bottom trace.

BASIC OPERATION AND FEATURES

The NiQor series non-isolated converter uses a buck converter that keeps the output voltage constant over variations in line, load, and temperature. The NiQor modules employ synchronous rectification for very high efficiency.

Dissipation throughout the converter is so low that it does not require a heatsink or metal baseplate for operation. The NiQor converter can thus be built more simply and reliably using high yield surface mount techniques on a single PCB substrate.

The NiQor series of SIPs and SMT converters uses the established industry standard footprint and pin-out configurations.

CONTROL FEATURES

REMOTE ON/OFF (Pin 11): The ON/OFF input, Pin 11, permits the user to control when the converter is on or off. There are currently two options available for the ON/OFF input described in the table below. (contact factory for other options)

Option	Description	Pin-Open Converter state	Pin Action
O Logic	Negative/Open	On	Pull High = Off
P Logic	Positive/Open	On	Pull Low = Off

Figure A is a schematic view of the internal ON/OFF circuitry.

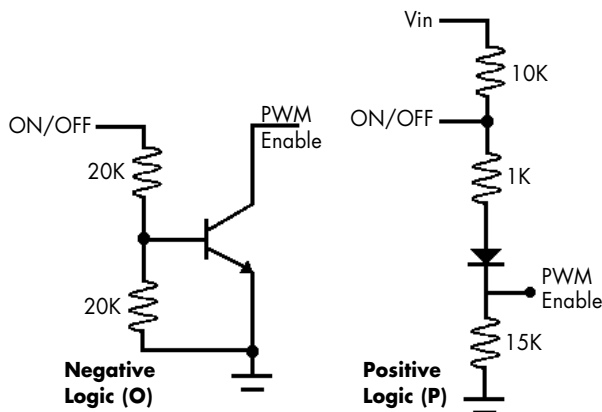

Figure A: Simplified Schematic of internal ON/OFF circuitry

OUTPUT VOLTAGE TRIM (Pin 10): The TRIM input permits the user to adjust the output voltage according to the trim range specifications by using an external resistor. If the TRIM feature is not being used, leave the TRIM pin disconnected.

TRIM (wide trim output unit): The output voltage of the NQ04T33 module can be programmed to any voltage from 0.85 to 3.6V by connecting a single external resistor R_{trim}

between Pin 10 (TRIM) and the Common Ground Pins. To achieve a desired output voltage V_{out} , the value of the resistor should be:

$$R_{trim} = \frac{21070}{V_{OUT} - 0.7525} - 5110 \quad (\Omega)$$

For example, to program an output voltage of 3.3V, the R_{trim} resistor value is calculated as follows:

$$R_{trim} = (21070 / (3.3 - 0.7525)) - 5110 = 3.16 \text{ k}\Omega$$

Note: the TRIM feature does not affect the voltage at which the output over-voltage protection circuit is triggered. Trimming the output voltage too high may cause the over-voltage protection circuit to engage, particularly during transients.

Total DC Variation of V_{out} : For the converter to meet its specifications, the maximum variation of the DC value of V_{out} , due to both trimming and remote load voltage drops, should not be greater than that specified for the output voltage trim range.

PROTECTION FEATURES

Input Under-Voltage Lockout: The converter is designed to turn off when the input voltage is too low, helping avoid an input system instability problem, described in more detail in the application note titled "Input System Instability". When the input voltage is rising, it must exceed the typical Turn-On Voltage Threshold value (listed on the specification page) before the converter will turn on. Once the converter is on, the input voltage must fall below the typical Turn-Off Voltage Threshold value before the converter will turn off.

Over Current Shutdown: The converter uses the control (high-side) MOSFET on-resistance to detect short circuit or excessive over-current conditions. The converter compensates for the temperature variation of the MOSFET on-resistance, keeping the overcurrent threshold roughly constant over temperature. Very short (<1mS) over-current pulses will see a slightly higher apparent threshold than longer duration over-current events. This makes the converter less susceptible to shutdown from transient load conditions. However, once the over-current threshold is reached the converter ceases PWM operation within microseconds. After an over-current shutdown, the converter will remain off for an inhibit period of 18 to 32 milliseconds, and then attempt a soft-start. Depending on the impedance or current level of the overload condition, the converter will enter a "hiccup mode" where it repeatedly turns on and off at a frequency of 25 to 50 Hz, until the overload or

short circuit condition is removed.

Output Over-Voltage Limit: If the voltage across the output pins exceeds the Output Over-Voltage Protection threshold, the converter will immediately stop switching. This prevents damage to the load circuit due to 1) excessive series resistance in output current path from converter output pins to sense point, 2) a release of a short-circuit condition, or 3) a release of a current limit condition. Load capacitance determines exactly how high the output voltage will rise in response to these conditions. After 2-4 ms, the converter will automatically restart. Note the wide trim model has a typical OVP threshold of 4.1V.

Over-Temperature Shutdown: A temperature sensor on the converter senses the average temperature of the module. The thermal shutdown circuit is designed to turn the converter off when the temperature at the sensed location reaches the Over-Temperature Shutdown value. It will allow the converter to turn on again when the temperature of the sensed location falls by the amount of the Over-Temperature Shutdown Restart Hysteresis value.

APPLICATION CONSIDERATIONS

Input and Output Filtering: SynQor recommends an external input capacitor of either a tantalum, polymer or aluminum electrolytic type on the input of the NQ03/NQ04 series non-isolated converters. This capacitance and resistance primarily provides damping of the input filter, reduces the source impedance and guarantees input stability (see SynQor application note "Input System Instability"). The input filter is formed by any source or wiring inductance and the converter's input capacitance. The external capacitance also provides an additional benefit of ripple voltage reduction.

A modest sized capacitor would suffice in most conditions, such as a 330 μ F, 16V tantalum, with an ESR of approximately 50 m Ω . The NiQor family converters have an internal ceramic input capacitor to reduce ripple current stress on the external capacitors. An external ceramic capacitor of similar size (330 μ F) with a series resistor of approximately 50 m Ω would also suffice and would provide the filter damping.

Additional ceramic capacitance may be needed on the input, in parallel with the tantalum capacitor, to relieve ripple current stress on the tantalum capacitors. The external capacitance forms a current divider with the 40 μ F internal ceramic capacitance. At 300 kHz., the impedance of the internal capacitance is about 15m Ω capacitive. At that frequency, an SMT 330 μ F tantalum capacitor would have an impedance of about 50m Ω resistive, essentially just the ESR.

In this example, at full load, that would stress the tantalum input capacitor to about 3A rms ripple current, possibly beyond its rating. Placing an additional 40 μ F of ceramic in parallel with that capacitor would reduce the ripple current to about 1.5A, probably within its rating at 85°C. The input ripple current is proportional to load current, so this example should be scaled down according to the actual load current.

Additional input capacitance equal to half of the output capacitance is recommended when operating with more than 1000 μ F of output capacitance on lower voltage outputs when trimming down by more than half of the trim-down allowance (e.g., further than -2.5% on a 0.9V, or -5% on a 1.2V).

Input inductance should be reduced for maintaining input stability when operating with large output capacitance (>1000 μ F). Reducing input inductance to <0.3 μ H provides for good phase margin with up to the 4000 μ F maximum output capacitance. If the input inductance must be increased up to 1 μ H even with large output capacitance (>1000 μ F), an input capacitance equal to or greater than the output capacitance may be needed to compensate the input impedance.

If no inductor is used to isolate the input ripple of the NiQor converters from the source or from inputs of other NiQor converters, then this external capacitance might be provided by the DC/DC converter used as the power source. SynQor's PowerQor series converters typically have tantalum and ceramic output capacitors that would provide the damping.

An input inductor would help isolate the ripple currents and voltages from the source or other NiQor style converters on the voltage supply rail. If an input inductor is used, the recommended capacitance should guarantee stability and control the ripple current for up to 1.0 μ H of input inductance.

The input inductor need not have very high inductance. A value of 250 nanohenries would equate to almost 500 miliohm of series impedance at the switching frequency of 300 kHz. This would be working against an assumed capacitive ESR of 30m Ω on the supply side of the inductor, providing significant isolation and ripple reduction.

No external capacitance is required at the output, however, the ripple voltage can be further reduced if ceramic and tantalum capacitors are added at the output. Since the internal output capacitance is about 50 μ F, approximately that amount of ceramic capacitance would be needed to produce a noticeable reduction in output ripple. The value of the tantalum capacitors is both to provide a high capacitance for pulsed loads and to provide damping of the distribution network with their inherent ESR, which is low, but higher than ceramics. Additional output

capacitance in the range of 300-500µF is beneficial for reducing the deviation in response to a fast load transient.

Input Over-Voltage Prevention: The power system designer must take precautions to prevent damaging the NiQor converters by input overvoltage. This is another reason to be careful about damping the input filter so that no ringing occurs from an underdamped filter. The voltage must be prevented from exceeding the absolute maximum voltage indicated in the Electrical Specifications section of the data sheet under all conditions of turn-on, turn-off and load transients and fault conditions. The power source should have an over voltage shutdown threshold as close as reasonably possible to the operating point.

Additional protection can come from additional input capacitance, perhaps on the order of 1,000µF, but contingent on the source inductance value. A large source inductance would require more capacitance to keep the input voltage below the absolute maximum, if the load current were interrupted suddenly. This can be caused by either a shutdown of the NiQor from a fault or from the load itself, for example when a card is hot-swapped out, suddenly dropping the load to zero. This is further justification for keeping the source inductance low, as mentioned above. When the power source is configured with remote sensing, the series resistance of the filter inductor and any other conductors or devices between the source and the sense point will result in a voltage drop which, in the event of a load current interruption, would add to the NiQor input voltage.

A TVS device could also be used to clamp the voltage level during these conditions, but the relatively narrow range between operating voltage and the absolute maximum voltage restrict the use of these devices to lower source current levels that will not drive the transient voltage suppressor above the voltage limit when all the source current is flowing into the clamp. A TVS would be a good supplemental control, in addition to careful selection of inductance and capacitance values.

Equivalent Model for Input Ripple: A simple but reasonably accurate model of input ripple is to treat the NiQor input as a pulsed AC current source at 300 kHz. in parallel with a very low ESR capacitor, see Figure B. The peak-to-peak current of the source model is equal to the NiQor load current, representing the peak current in the NiQor's smoothing choke. The capacitor represents the 40µF input ceramic capacitance of the NiQor converter, with a nearly negligible ESR of less than 1 mΩ. A further refinement can be made by setting the duty cycle of the pulsed source to the output voltage divided by the input voltage.

The only error in this simplified model is that it ignores the ripple current in the choke, usually less than 20% of the load current, and it ignores the resistive losses inside the NiQor converter, which would alter the duty cycle very slightly.

The model is a good guide for calculating the effects of external input capacitors and other filter elements on ripple voltage and ripple current stress on capacitors.

High Capacitance Loads with Backdrive: When using two or more NiQor converters with high capacitance loads

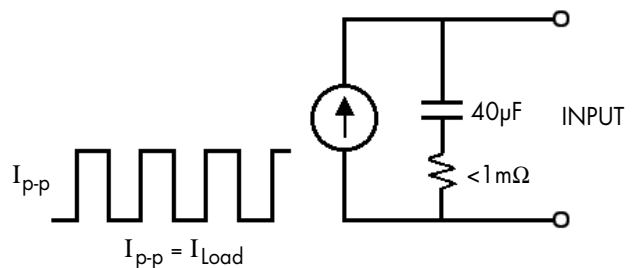

Figure B: Equivalent model for input ripple

(greater than 1,000µF), special consideration must be given to the following condition. If a back-drive source is feeding voltage back to a NiQor output, perhaps through some ASIC or other load device, and the back-driving source is greater than 60% of the input voltage to the NiQor that has not been enabled yet, an overcurrent condition may exist on startup. This condition could prevent a proper startup when the second NiQor is enabled. The condition is caused by the second NiQor having to ramp the voltage to a high duty cycle with a high capacitance load, which can trip the overcurrent shutdown, preventing a startup. The following remedies for this situation can be applied:

- 1) Limit output capacitance on higher voltage outputs to 1,000µF. OR,
- 2) Prevent back-drive conditions that raise the off-state output voltage to more than 60% of the input voltage.

Thermal Considerations: For vertical mount applications at elevated temperatures that call for forced air cooling (see thermal derating curves - measured using 6 layer 2oz copper board), the preferred airflow direction is from pin 11 to pin 1, as indicated in the thermal images provided. If airflow is in the opposite direction (pin 1 to pin 11) the power devices will run hotter by about 5 °C (corresponding to an additional 1 ampere of load derating at conditions where derating occurs).

For horizontal mount applications (NQ0xxxHKA parts), where the inductor and power devices are facing down, the preferred



Technical Specification

Input: 3.0 - 5.5V
Outputs: 0.9 - 3.3V
Current: 10A
Package: SIP

airflow direction is into the leading edge opposite the pin header edge, such that air flowing under the *NiQor* PCB flows out between the pins and the inductor. With this airflow direction, and with the inductor firmly contacting the application board, the user can apply the thermal derating curves provided herein (measured using 6 layer 2oz copper board) for vertical mount with airflow from pin 11 to pin 1. Airflows in other directions across the horizontally mounted *NiQor* will result in temperatures that are higher by about 5 °C with pin 11 to pin 1 airflow and about 10 °C with pin 1 to pin 11 airflow. Also, temperature increases of up to 10 °C (2 Amp lower derating) can be expected if the inductor thermal interface does not make good contact to the customer's circuit board.

Layout Suggestion: When using a fixed output *NiQor* converter, the designer may choose to use the trim function and would thus be required to reserve board space for a trim resistor. It is suggested that even if the designer does not plan to use the trim function, additional space should be reserved on the board for a trim resistor. This will allow the flexibility to use the wide output voltage trim range *NiQor* module at a later date. Any trim resistor should connect to the ground or output node at one of the respective pins of the *NiQor*, so as to prevent the trim level from being affected by load drops through the ground or power planes.

OPTIONAL FEATURES

REMOTE SENSE(+) (Pin 3 - Optional): The optional SENSE(+) input corrects for voltage drops along the conductors that connect the converter's output pins to the load.

Pin 3 should be connected to Vout(+) at the point on the board where regulation is desired. A remote connection at the load can adjust for a voltage drop only as large as that specified in this datasheet, that is

$$V_{out(+)} - SENSE(+) \leq \text{Sense Range \%} \times V_{out}$$

Pin 3 must be connected for proper regulation of the output voltage. If these connections are not made, the converter will deliver an output voltage that is slightly higher than its specified value.

Note: the output over-voltage protection circuit senses the voltage across the output (pins 1, 2 and 4) to determine when it should trigger, not the voltage across the converter's sense lead (pin 3).

RoHS Compliance: The EU led RoHS (Restriction of Hazardous Substances) Directive bans the use of Lead, Cadmium, Hexavalent Chromium, Mercury, Polybrominated Biphenyls (PBB), and Polybrominated Diphenyl Ether (PBDE) in Electrical and Electronic Equipment. SynQor products are currently 5/6 RoHS compliant with lead being the exception. For more information please visit our [RoHS Compliance / Lead Free Initiative](#) web or e-mail us at rohs@synqor.com.



Technical Specification

Input: 3.0 - 5.5V
Outputs: 0.9 - 3.3V
Current: 10A
Package: SIP

PART NUMBERING SYSTEM

The part numbering system for SynQor's NiQor DC/DC converters follows the format shown in the example below.

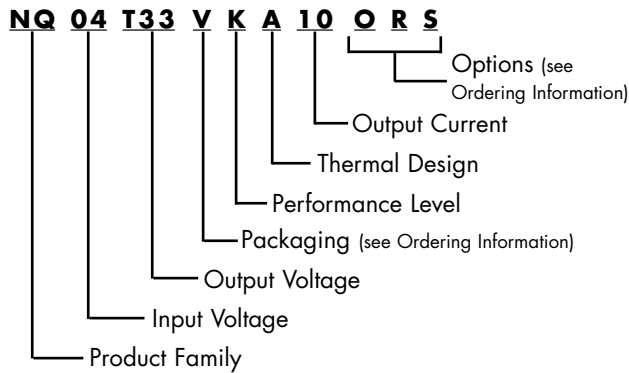

The first 12 characters comprise the base part number and the last 3 characters indicate available options. Although there are no default values for packaging, enable logic, pin length and feature set, the most common options are vertical mount SIP (V), Negative/Open logic (O), 0.160" pins (R) and Sense feature set (S). These part numbers are more likely to be readily available in stock for evaluation and prototype quantities.

Application Notes

A variety of application notes and technical white papers can be downloaded in pdf format from our [website](#).

Contact SynQor for further information:

Phone: 978-849-0600
Toll Free: 888-567-9596
Fax: 978-849-0602
E-mail: power@synqor.com
Web: www.synqor.com
Address: 155 Swanson Road
 Boxborough, MA 01719
 USA

ORDERING INFORMATION

The tables below show the valid model numbers and ordering options for converters in this product family. When ordering SynQor converters, please ensure that you use the complete 15 character part number consisting of the 12 character base part number and the additional 3 characters for options.

Model Number	Input Voltage	Output Voltage	Max Output Current
NQ04T33pKA10xyz*	3.0 - 5.5 V	0.85-3.6V	10 A

The following option choices must be included in place of the p x y z spaces in the model numbers listed above.

Packaging: <i>p</i>	Options Description: <i>xyz</i>		
Packaging	Enable Logic	Pin Style	Feature Set
V - Vert. Mount SIP H - Horz. Mount SIP	O - Neg./Open P - Pos./Open	R - 0.160" (Standard) V - 0.160" (Vert Reversed)	S - Sense (Std.) N - None

Warranty

SynQor offers a three (3) year limited warranty. Complete warranty information is listed on our [website](#) or is available upon request from SynQor.

Information furnished by SynQor is believed to be accurate and reliable. However, no responsibility is assumed by SynQor for its use, nor for any infringements of patents or other rights of third parties which may result from its use. No license is granted by implication or otherwise under any patent or patent rights of SynQor.