



# M40S-042200AR0, M40E-042200RR0

M4000 Standard

**MULTIPLE LIGHT BEAM SAFETY DEVICES**

**SICK**  
Sensor Intelligence.

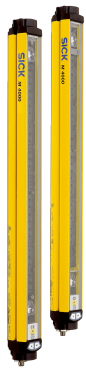

### Ordering information

System part	Type	Part no.
Sender	M40S-042200ARO	1200005
Receiver	M40E-042200RRO	1200022

Other models and accessories → [www.sick.com/M4000\\_Standard](http://www.sick.com/M4000_Standard)



### Detailed technical data

#### Features

<b>Scanning range</b>	0.5 m ... 70 m, configurable
<b>Low scanning range</b>	0.5 m ... 20 m
<b>Great scanning range</b>	9 m ... 70 m
<b>Number of beams</b>	4
<b>Beam separation</b>	220 mm
<b>Response time</b>	10 ms
<b>Synchronization</b>	Optical synchronisation

#### Safety-related parameters

<b>Type</b>	Type 4 (IEC 61496)
<b>Safety integrity level</b>	SIL3 (IEC 61508) SILCL3 (EN 62061)
<b>Category</b>	Category 4 (EN ISO 13849)
<b>Performance level</b>	PL e (EN ISO 13849)
<b>PFH<sub>D</sub> (mean probability of a dangerous failure per hour)</b>	$6.6 \times 10^{-9}$ (EN ISO 13849)
<b>T<sub>M</sub> (mission time)</b>	20 years (EN ISO 13849)
<b>Safe state in the event of a fault</b>	At least one OSSD is in the OFF state.

#### Functions

	Functions	Delivery status
<b>Restart interlock</b>	✓	Internal
<b>External device monitoring (EDM)</b>	✓	Activated
<b>Beam coding</b>	✓	Uncoded
<b>Sender test</b>	✓	Deactivated
<b>Configurable scanning range</b>	✓	0.5 m ... 20 m
<b>Configurable application diagnostic output</b>	✓	Contamination (OWS)

## Interfaces

<b>System connection</b>	Connection type	Male connector M12, 8-pin
	Permitted cable length	≤ 15 m <sup>1)</sup>
	Permitted cross-section	≥ 0.25 mm <sup>2</sup>
<b>Configuration method</b>	Configuration buttons	
<b>Display elements</b>	LEDs 7-segment display	
<b>Fieldbus, industrial network</b>	Integration via Flexi Soft safety controller	
	CANopen, DeviceNet™, EtherCAT®, EtherNet/IP™, Modbus TCP, PROFIBUS DP, PROFINET <sup>2)</sup>	

<sup>1)</sup> Depending on load, power supply and wire cross-section. The technical specifications must be observed.

<sup>2)</sup> For additional information on Flexi Soft -> [www.sick.com/Flexi\\_Soft](http://www.sick.com/Flexi_Soft).

## Electrical data

<b>Protection class</b>	III (EN 50178)	
<b>Supply voltage <math>V_S</math></b>	24 V DC (19.2 V DC ... 28.8 V DC) <sup>1)</sup>	
<b>Residual ripple</b>	≤ 10 % <sup>2)</sup>	
<b>Power consumption</b>	≤ 0.2 A: ≤ 0.6 A (depending on type)	
<b>Safety outputs (OSSD)</b>	Type of output	2 PNP semiconductors, short-circuit protected, cross-circuit monitored <sup>3)</sup>
	Switching voltage HIGH	24 V DC ( $V_S - 2.25$ V DC ... $V_S$ )
	Switching voltage LOW	≤ 2 V DC
	Switching current	≤ 500 mA
<b>Diagnostic outputs</b>	Type of output	PNP semiconductor, short-circuit protected
	Switching voltage HIGH	24 V DC ( $V_S - 4.2$ V DC ... $V_S$ )
	Switching voltage LOW	High resistance
	Switching current	≤ 100 mA

<sup>1)</sup> The external voltage supply must be capable of buffering brief mains voltage failures of 20 ms as specified in EN 60204-1. Suitable power supplies are available as accessories from SICK.

<sup>2)</sup> Within the limits of  $V_S$ .

<sup>3)</sup> Applies to the voltage range between -30 V and +30 V.

## Mechanical data

<b>Housing cross-section</b>	52 mm x 55.5 mm
<b>Housing material</b>	Aluminum alloy ALMGSI 0.5
<b>Surface treatment</b>	Powder coated
<b>Front screen material</b>	Polycarbonate, scratch-resistant coating

## Ambient data

<b>Enclosure rating</b>	IP65 (EN 60529)
<b>Ambient operating temperature</b>	-30 °C ... +55 °C
<b>Storage temperature</b>	-30 °C ... +70 °C
<b>Air humidity</b>	15 % ... 95 %, Non-condensing
<b>Vibration resistance</b>	5 g, 10 Hz ... 55 Hz (IEC 60068-2-6)

<b>Shock resistance</b>	10 g, 16 ms (IEC 60068-2-29)
-------------------------	------------------------------

Other information

<b>Wave length</b>	950 nm
--------------------	--------

Classifications

<b>ECl@ss 5.0</b>	27272703
<b>ECl@ss 5.1.4</b>	27272703
<b>ECl@ss 6.0</b>	27272703
<b>ECl@ss 6.2</b>	27272703
<b>ECl@ss 7.0</b>	27272703
<b>ECl@ss 8.0</b>	27272703
<b>ECl@ss 8.1</b>	27272703
<b>ECl@ss 9.0</b>	27272703
<b>ETIM 5.0</b>	EC001832
<b>ETIM 6.0</b>	EC001832
<b>UNSPSC 16.0901</b>	46171620

Dimensional drawing (Dimensions in mm (inch))



Number of beams	Beam separation S1	L1	L2
2	500 (19.69)	643 (25.31)	672 (26.46)
	600 (23.62)	743 (29.25)	772 (30.39)
3	220 (8.66)	583 (22.95)	612 (24.09)
	400 (15.75)	943 (37.13)	972 (38.27)
	450 (17.72)	1,043 (41.06)	1,072 (42.20)
4	220 (8.66)	803 (31.61)	832 (32.76)
	300 (11.81)	1,043 (41.06)	1,072 (42.20)
5	220 (8.66)	1,023 (40.28)	1,052 (41.42)
6		1,243 (48.94)	1,272 (50.08)
7		1,462 (57.56)	1,491 (58.70)
8		1,682 (66.22)	1,711 (67.36)

### Connection diagram

M4000 Standard connected to UE10-30S safety relay

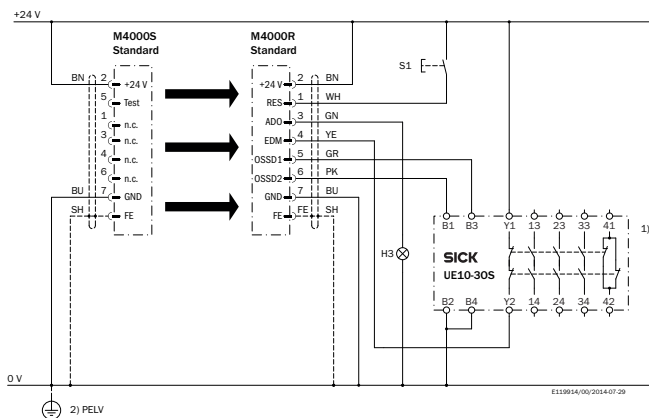

### Task

Connection of an M4000 Standard multiple light beam safety device to a UE10-30S safety relay.

Operating mode: with restart interlock and external device monitoring.

### Operating characteristics

When the light path is clear and the UE10-30S is de-energized and functioning correctly, the yellow LED on the receiver and the H3 lamp flash. The system is ready for switch-on and waits for an input signal/switch-on signal. The system is enabled by pressing and releasing the S1 button. The OSSD1 and OSSD2 outputs are live, the UE10-30S is switched on. On interruption of one or several of the light beams, the UE10-30S is de-energized by the OSSD1 and OSSD2 outputs.

### Fault analysis

OSSD cross-circuits and short-circuits are detected and lead to the inhibited state (lock-out). The erroneous behavior of the UE10-30S will be detected. The shutdown function is retained. On manipulation (e.g., jamming) of the S1 button, the system does not enable the output current circuits.

### Comments





<sup>1)</sup> Output circuits: These contacts are to be connected to the controller such that, with the output circuit open, the dangerous state is disabled. For categories 4 and 3, this integration must be dual-channel (x/y paths). Single-channel insertion in the control (z path) is only possible with a single-channel control and by taking the risk analysis into account.

<sup>2)</sup> PELV in accordance with the requirements in EN 60204-1 / 6.4

Take note of the operating instructions of the integrated devices.

### Recommended accessories

Other models and accessories → [www.sick.com/M4000\\_Standard](http://www.sick.com/M4000_Standard)

	Brief description	Type	Part no.
<b>Mounting brackets and plates</b>			
	4 pieces, Mounting kit 1, mounting bracket, rigid, L-shaped, including fixing screws and washers	BEF-3WNGBAST4	7021352
<b>Terminal and alignment brackets</b>			
	4 pieces, Mounting kit 6, side bracket, rotatable, Zinc diecast	BEF-1SHABAZN4	2019506
	4 pieces, Mounting kit 12, rotatable, swivel mount	BEF-2SMGEAKU4	2030510
<b>Alignment aids</b>			
	Laser alignment aid for various sensors, laser class 2 (IEC 60825). Do not look into the beam!	AR60	1015741
	Adapter AR60 for M4000 and M4000 Curtain	AR60 adapter, M4000	4040006

## SICK AT A GLANCE

SICK is one of the leading manufacturers of intelligent sensors and sensor solutions for industrial applications. A unique range of products and services creates the perfect basis for controlling processes securely and efficiently, protecting individuals from accidents and preventing damage to the environment.

We have extensive experience in a wide range of industries and understand their processes and requirements. With intelligent sensors, we can deliver exactly what our customers need. In application centers in Europe, Asia and North America, system solutions are tested and optimized in accordance with customer specifications. All this makes us a reliable supplier and development partner.

Comprehensive services complete our offering: SICK LifeTime Services provide support throughout the machine life cycle and ensure safety and productivity.

For us, that is “Sensor Intelligence.”

## WORLDWIDE PRESENCE:

Contacts and other locations –[www.sick.com](http://www.sick.com)