

OPTIREG™ Linear TLE4276

Low Drop Voltage Regulator



Features

- 5 V, and variable output voltage
- Output voltage tolerance $\leq \pm 4\%$
- 400 mA current capability
- Low-drop voltage
- Inhibit input
- Very low current consumption
- Short-circuit-proof
- Reverse polarity proof
- Suitable for use in automotive electronics
- Green Product (RoHS compliant)

Potential applications

Automotive applications especially with tight space constraints.

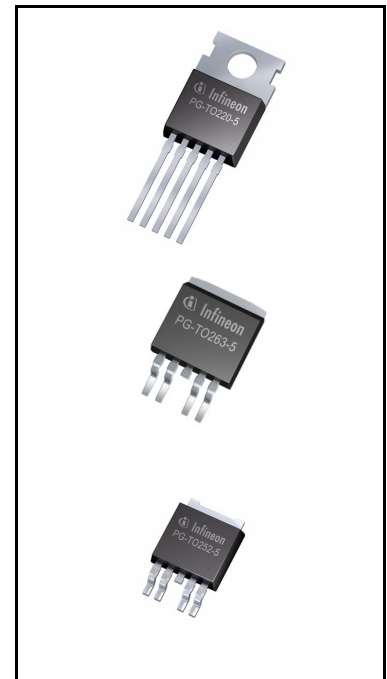

Product validation

Qualified for Automotive Applications. Product Validation according to AEC-Q100/101.

Description

The OPTIREG™ Linear TLE4276 is a low-drop voltage regulator in a TO package. The IC regulates an input voltage up to 40 V to $V_{Q,nom} = 5.0$ V (V50), and adjustable voltage (V). The maximum output current is 400 mA. The IC can be switched off via the inhibit input, which causes the current consumption to drop below 10 μ A. The IC is short-circuit-proof and includes temperature protection which turns off the device at overtemperature.

Type	Package	Marking
TLE4276SV	PG-TO220-5	4276V
TLE4276GV50	PG-TO263-5	4276V50
TLE4276GV	PG-TO263-5	4276V
TLE4276DV50	PG-TO252-5	4276V50
TLE4276DV	PG-TO252-5	4276V

Table of Contents

1	Block Diagram	3
2	Pin Configuration	4
2.1	Pin Assignments	4
3	Functional Description	5
3.1	Typical Performance Graphs	11
4	Package information	13
5	Revision History	15

Block Diagram

1 Block Diagram

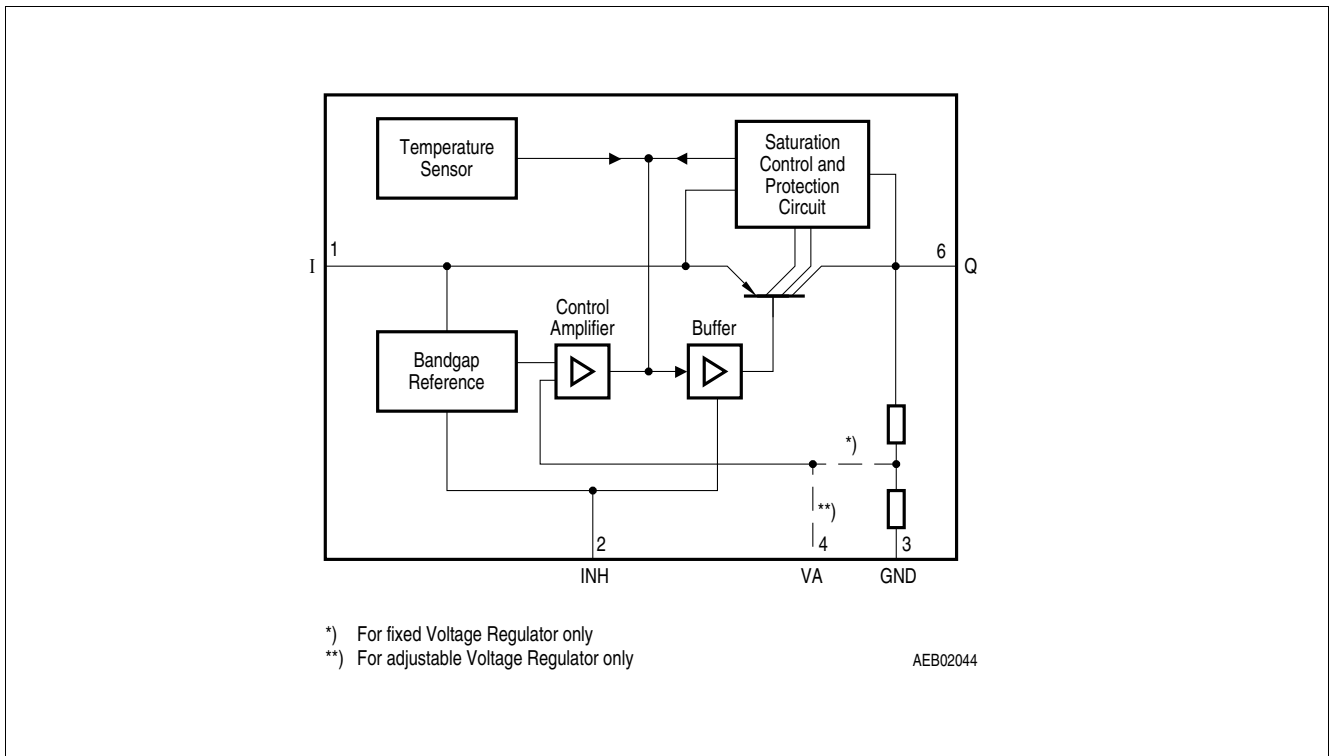

Figure 1 Block Diagram

Pin Configuration

2 Pin Configuration

2.1 Pin Assignments

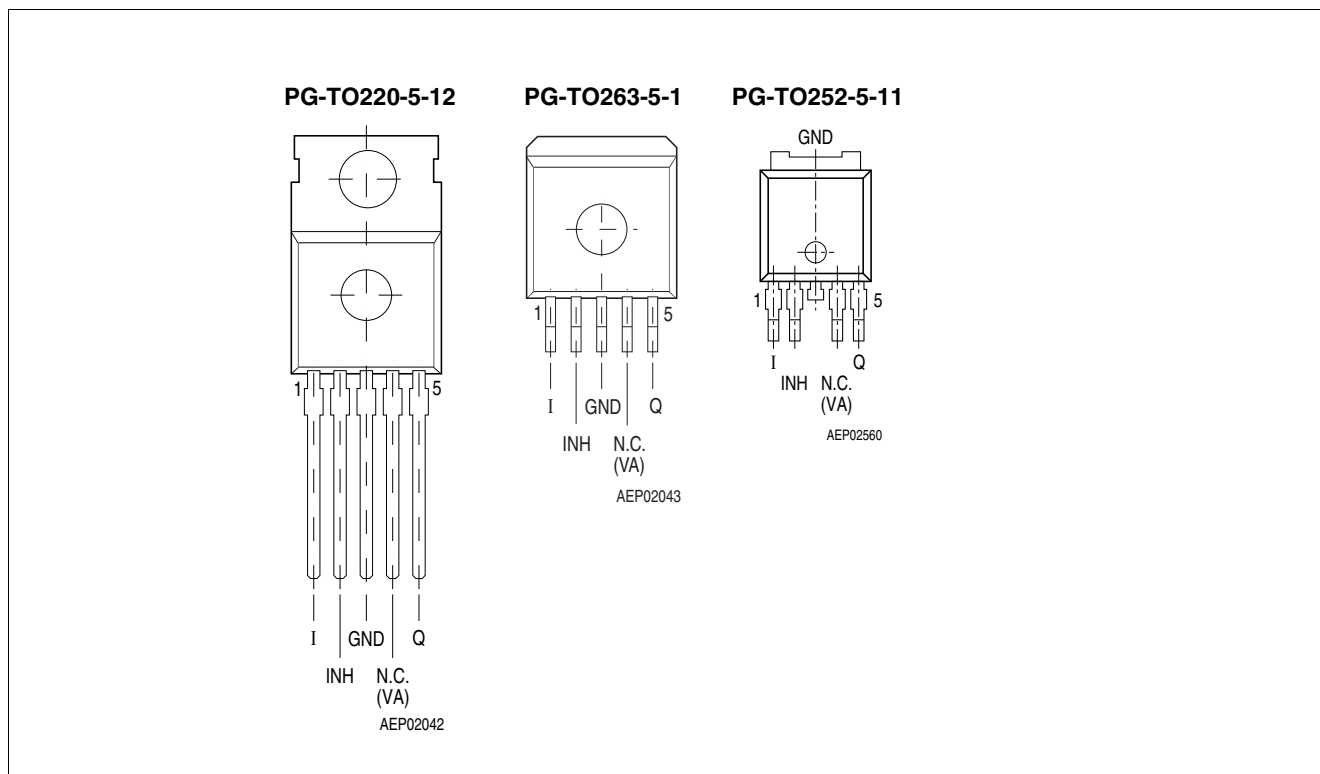

Figure 2 Pin Configuration (top view)

Table 1 Pin Definitions and Functions

Pin No.	Symbol	Function
1	I	Input; block to ground directly at the IC with a ceramic capacitor.
2	INH	Inhibit; low-active input.
3	GND	Ground
4	N.C. VA	Not connected for V50 Voltage Adjust Input; only for adjustable version. Connect an external voltage divider to determine the output voltage.
5	Q	Output; block to GND with a $\geq 22 \mu\text{F}$ capacitor, $\text{ESR} \leq 3 \Omega$ at 10 kHz
Heatsink		Connect to GND.

3 Functional Description

Functional Description

The OPTIREG™ Linear TLE4276 is a low-drop voltage regulator in a TO package. The IC regulates an input voltage up to 40 V to $V_{Q,nom} = 5.0$ V (V50), and adjustable voltage (V). The maximum output current is 400 mA. The IC can be switched off via the inhibit input, which causes the current consumption to drop below 10 μ A. The IC is short-circuit-proof and includes temperature protection which turns off the device at overtemperature.

Dimensioning Information on External Components

The input capacitor C_I is necessary for compensation of line influences. Using a resistor of approx. 1 Ω in series with C_I , the oscillating of input inductivity and input capacitance can be damped. The output capacitor C_O is necessary for the stability of the regulation circuit. Stability is guaranteed at values $C_O \geq 22$ μ F and an ESR of ≤ 3 Ω within the operating temperature range.

Circuit Description

The control amplifier compares a reference voltage to a voltage that is proportional to the output voltage and drives the base of the series transistor via a buffer. Saturation control as a function of the load current prevents any oversaturation of the power element. The IC also incorporates a number of internal circuits for protection against:

- Overload
- Overtemperature
- Reverse polarity

Functional Description

Table 2 Absolute Maximum Ratings

Parameter	Symbol	Limit Values		Unit	Test Condition
		Min.	Max.		
Input I					
Voltage	V_I	-42	45	V	-
Current	I_I	-	-	-	Internally limited
Inhibit INH					
Voltage	V_{INH}	-42	45	V	-
Voltage Adjust Input VA					
Voltage	V_{VA}	-0.3	10	V	-
Output Q					
Voltage	V_Q	-1.0	40	V	-
Current	I_Q	-	-	-	Internally limited
Ground GND					
Current	I_{GND}	-	100	mA	-
Temperature					
Junction temperature	T_j	-40	150	°C	-
Storage temperature	T_{stg}	-50	150	°C	-

Note: Maximum ratings are absolute ratings; exceeding any one of these values may cause irreversible damage to the integrated circuit.

Table 3 ESD Rating

Parameter	Symbol	Limit Values		Unit	Notes
		Min.	Max.		
ESD Capability	$V_{ESD,HBM}$	2000	-	V	Human Body Model

Functional Description

Table 4 Operating Range

Parameter	Symbol	Limit Values		Unit	Remarks
		Min.	Max.		
Input voltage	V_I	$V_Q + 0.5$	40	V	Fixed voltage devices V50
Input voltage	V_I	$V_Q + 0.5$	40	V	Variable device V
Input voltage	V_I	4.5 V	40	V	Variable device V, $V_Q < 4$ V
Junction temperature	T_j	-40	150	°C	-

Thermal Resistance

Junction ambient	R_{thj-a}	-	65	K/W	TO220
Junction ambient	R_{thj-a}	-	80	K/W	TO252, TO263 ¹⁾
Junction case	R_{thj-c}	-	4	K/W	-

1) Package mounted on PCB 80 × 80 × 1.5 mm ; 35μ Cu; 5μ Sn; Footprint only; zero airflow.

Functional Description

Table 5 Characteristics

$V_I = 13.5 \text{ V}$; $-40 \text{ °C} < T_j < 150 \text{ °C}$ (unless otherwise specified)

Parameter	Symbol	Limit Values			Unit	Measuring Condition	Measuring Circuit
		Min.	Typ.	Max.			
Output voltage	V_Q	4.8	5.0	5.2	V	V50-Version $5 \text{ mA} < I_Q < 400 \text{ mA}$ $6 \text{ V} < V_I < 28 \text{ V}$	1
Output voltage	V_Q	4.8	5.0	5.2	V	V50-Version $5 \text{ mA} < I_Q < 200 \text{ mA}$ $6 \text{ V} < V_I < 40 \text{ V}$	1
Output voltage tolerance	ΔV_Q	-4	-	4	%	V-Version $R_2 < 50 \text{ k}\Omega$ $V_Q + 1 \text{ V} \leq V_I \leq 40 \text{ V}$ $V_I > 4.5 \text{ V}$ $5 \text{ mA} \leq I_Q \leq 400 \text{ mA}$	1
Output current limitation ¹⁾	I_Q	400	600	1100	mA	-	1
Current consumption; $I_q = I_I - I_Q$	I_q	-	-	10	μA	$V_{\text{INH}} = 0 \text{ V}$; $T_j \leq 100 \text{ °C}$	1
Current consumption; $I_q = I_I - I_Q$	I_q	-	100	220	μA	$I_Q = 1 \text{ mA}$	1
Current consumption; $I_q = I_I - I_Q$	I_q	-	5	10	mA	$I_Q = 250 \text{ mA}$	1
Current consumption; $I_q = I_I - I_Q$	I_q	-	15	25	mA	$I_Q = 400 \text{ mA}$	1
Drop voltage ¹⁾	V_{DR}	-	250	500	mV	V50 $I_Q = 250 \text{ mA}$ $V_{\text{DR}} = V_I - V_Q$	1
Drop voltage ¹⁾	V_{DR}	-	250	500	mV	variable devices $I_Q = 250 \text{ mA}$ $V_I > 4.5 \text{ V}$ $V_{\text{DR}} = V_I - V_Q$	1
Load regulation	$\Delta V_{Q,\text{Lo}}$	-	5	35	mV	$I_Q = 5 \text{ mA to } 400 \text{ mA}$	1
Line regulation	$\Delta V_{Q,\text{Li}}$	-	15	25	mV	$\Delta V_I = 12 \text{ V to } 32 \text{ V}$ $I_Q = 5 \text{ mA}$	1
Power supply ripple rejection	$PSRR$	-	54	-	dB	$f_r = 100 \text{ Hz}$; $V_r = 0.5 \text{ Vpp}$	1
Temperature output voltage drift	$\Delta V_Q/dT$	-	0.5	-	-	-	mV/K

Functional Description

Table 5 Characteristics (cont'd)

$V_I = 13.5\text{ V}$; $-40\text{ }^\circ\text{C} < T_j < 150\text{ }^\circ\text{C}$ (unless otherwise specified)

Parameter	Symbol	Limit Values			Unit	Measuring Condition	Measuring Circuit
		Min.	Typ.	Max.			
Inhibit on voltage	V_{INH}	–	2	3.5	V	$V_Q \geq 4.9\text{ V}$	1
Inhibit off voltage	V_{INH}	0.5	1.7	–	V	$V_Q \leq 0.1\text{ V}$	1
Input current	I_{INH}	5	10	20	μA	$V_{INH} = 5\text{ V}$	1

1) Measured when the output voltage V_Q has dropped 100 mV from the nominal value obtained at $V_I = 13.5\text{ V}$.

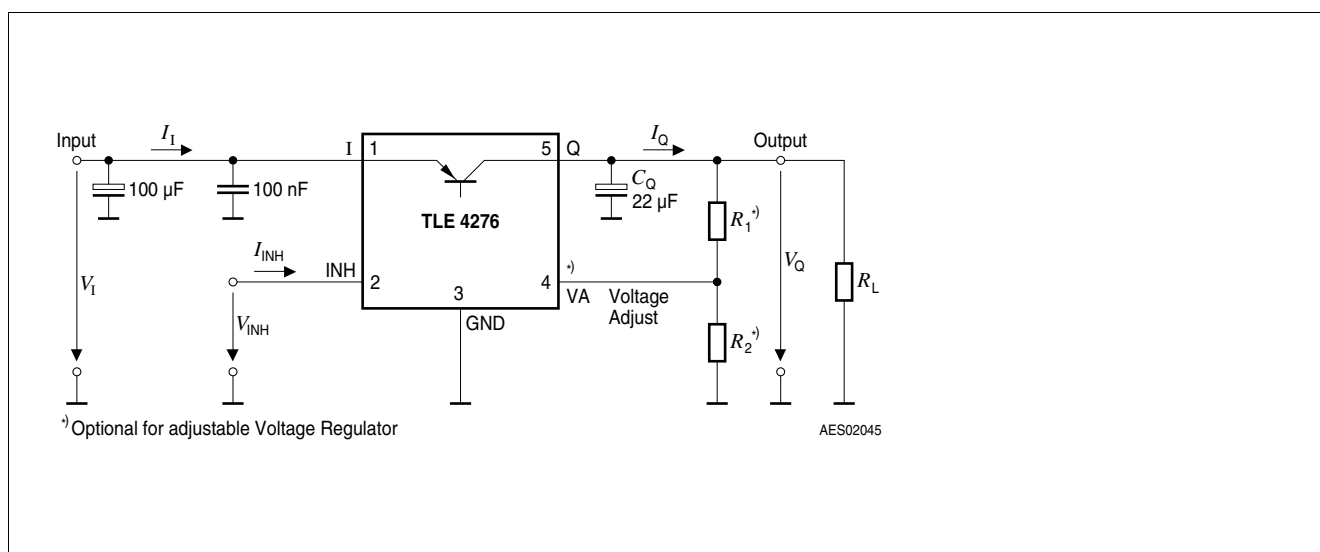

Figure 3 Measuring Circuit

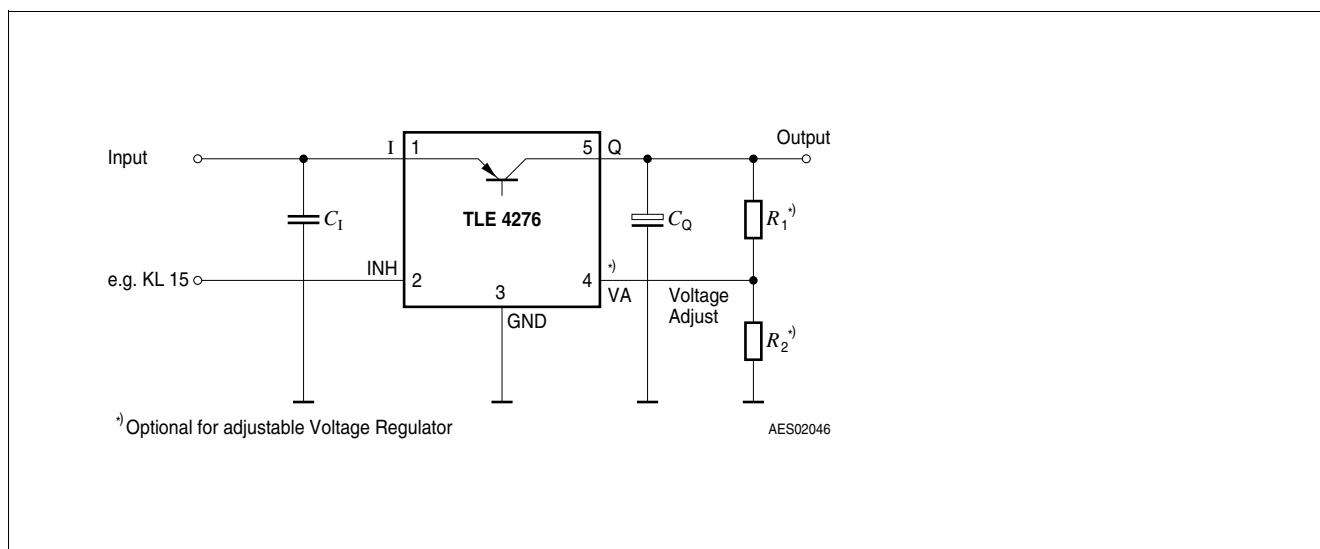

Figure 4 Application Circuit

Functional Description

Application Information for Variable Output Regulator TLE 4276 V

The output voltage of the TLE 4276 V can be adjusted between 2.5 V and 20 V by an external output voltage divider, closing the control loop to the voltage adjust pin VA.

The voltage at pin VA is compared to the internal reference of typical 2.5 V in an error amplifier. It controls the output voltage.

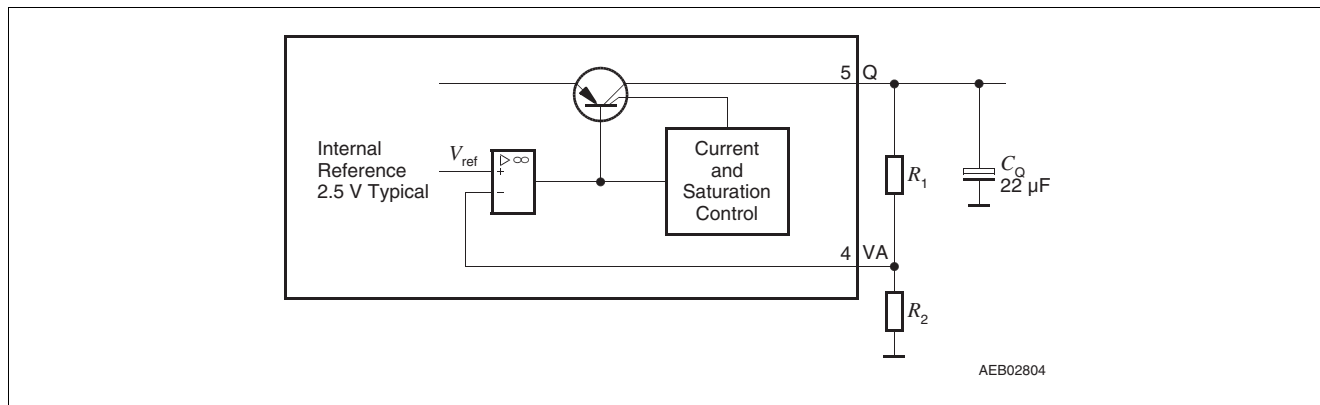

Figure 5 Application Detail External Components at Output for Variable Voltage Regulator

The output voltage is calculated according to **Equation (3.1)**:

$$V_Q = (R_1 + R_2) / R_2 \times V_{ref}, \text{ neglecting } I_{VA} \tag{3.1}$$

V_{ref} is typically 2.5 V.

To avoid errors caused by leakage current I_{VA} , we recommend to choose the resistor value R_2 according to **Equation (3.2)**:

$$R_2 < 50 \text{ k}\Omega \tag{3.2}$$

For a 2.5 V output voltage the output pin Q is directly connected to the adjust pin VA.

The accuracy of the resistors R_1 and R_2 add an additional error to the output voltage tolerance.

The operation range of the variable TLE 4276 V is $V_Q + 0.5 \text{ V}$ to 40 V. For internal biasing a minimum input voltage of 4.3 V is required. For output voltages below 4 V the voltage drop is $4.3 \text{ V} - V_Q$

Functional Description

3.1 Typical Performance Graphs

Typical Performance Characteristics V50

Voltage V_{DR} versus Output Current I_Q

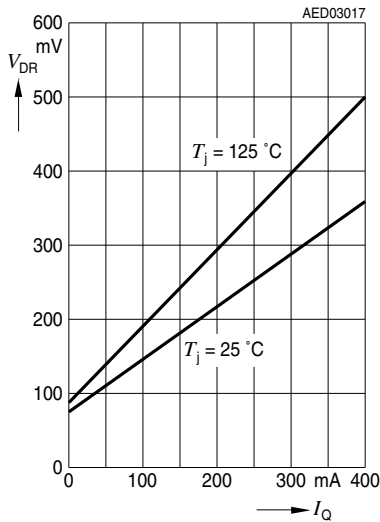

Current Consumption I_q versus Output Current I_Q (high load)

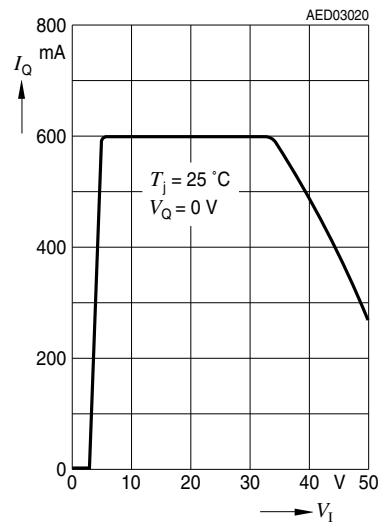

Max. Output Current I_Q versus Input Voltage V_I

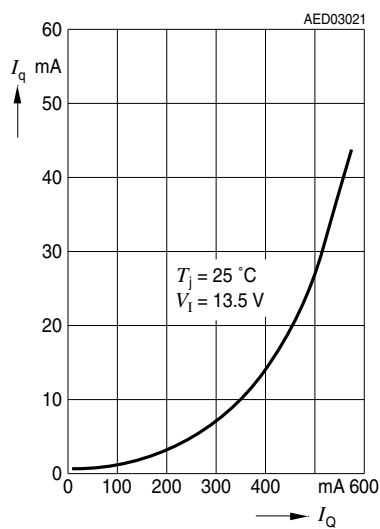

Current Consumption I_q versus Output Current I_Q (low load)

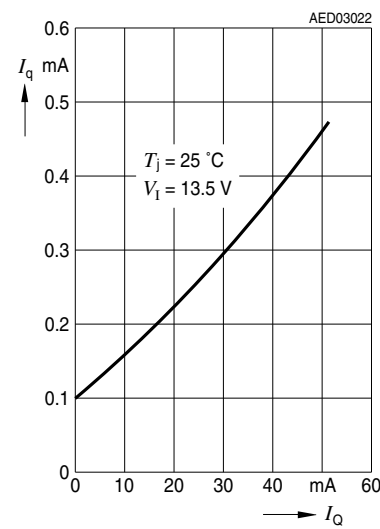

Functional Description

Output Voltage V_Q versus Temperature T_j

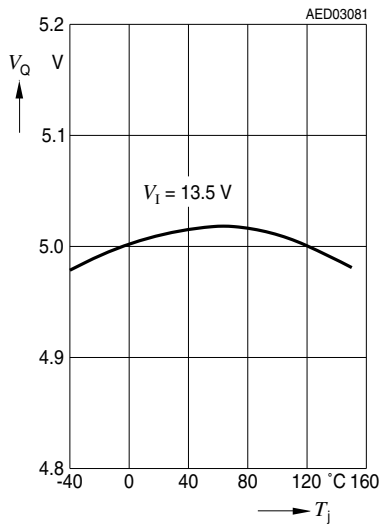

Current Consumption I_q versus Input Voltage V_I

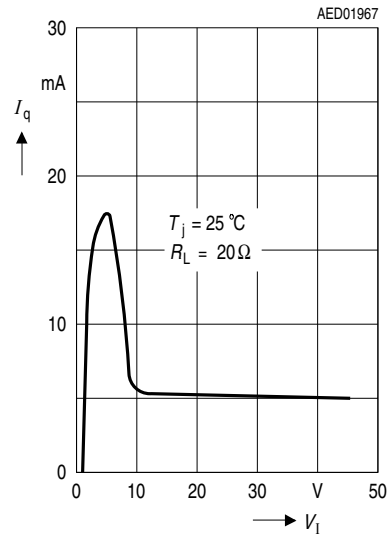

Low Voltage Behavior

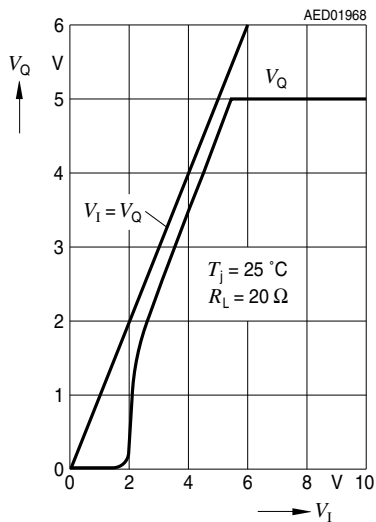

High Voltage Behavior

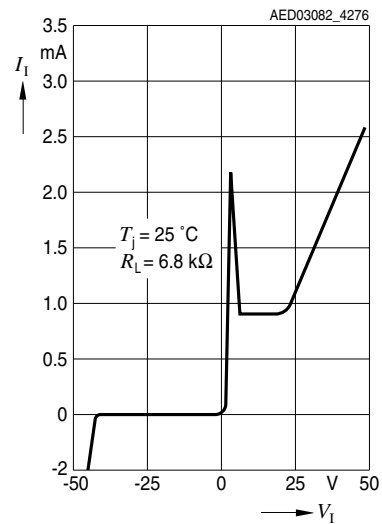

Package information

4 Package information

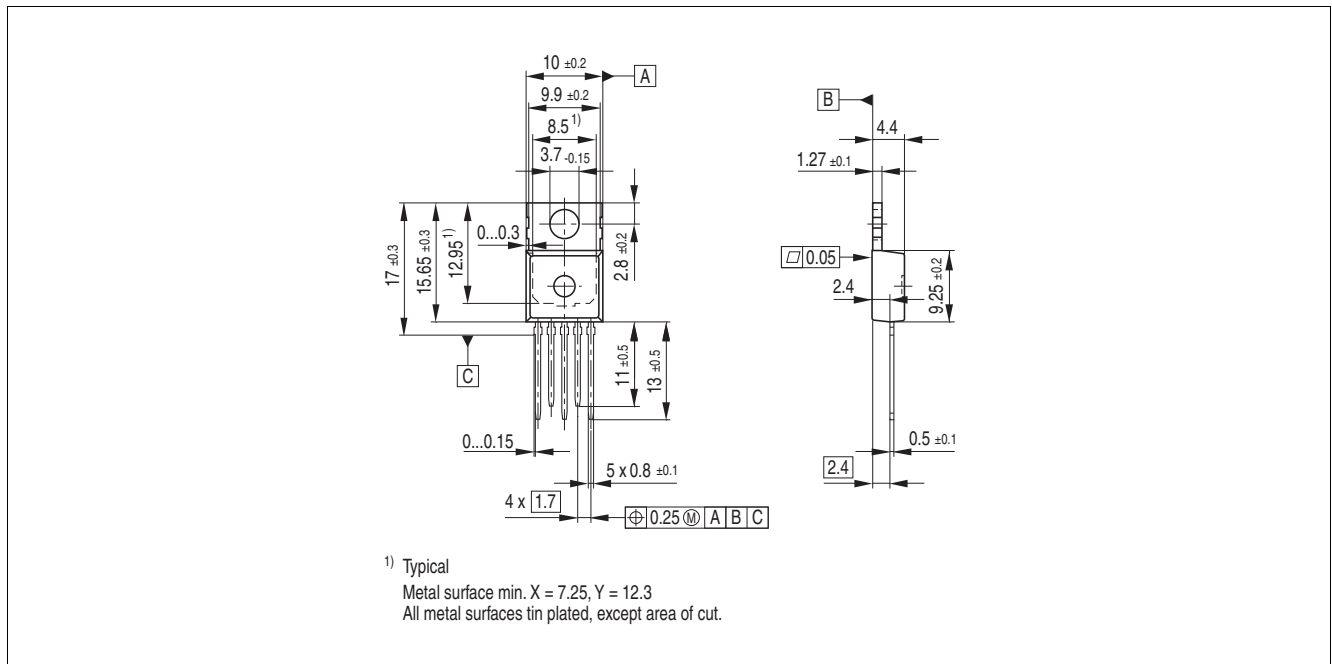

Figure 6 PG-TO220-5 1)

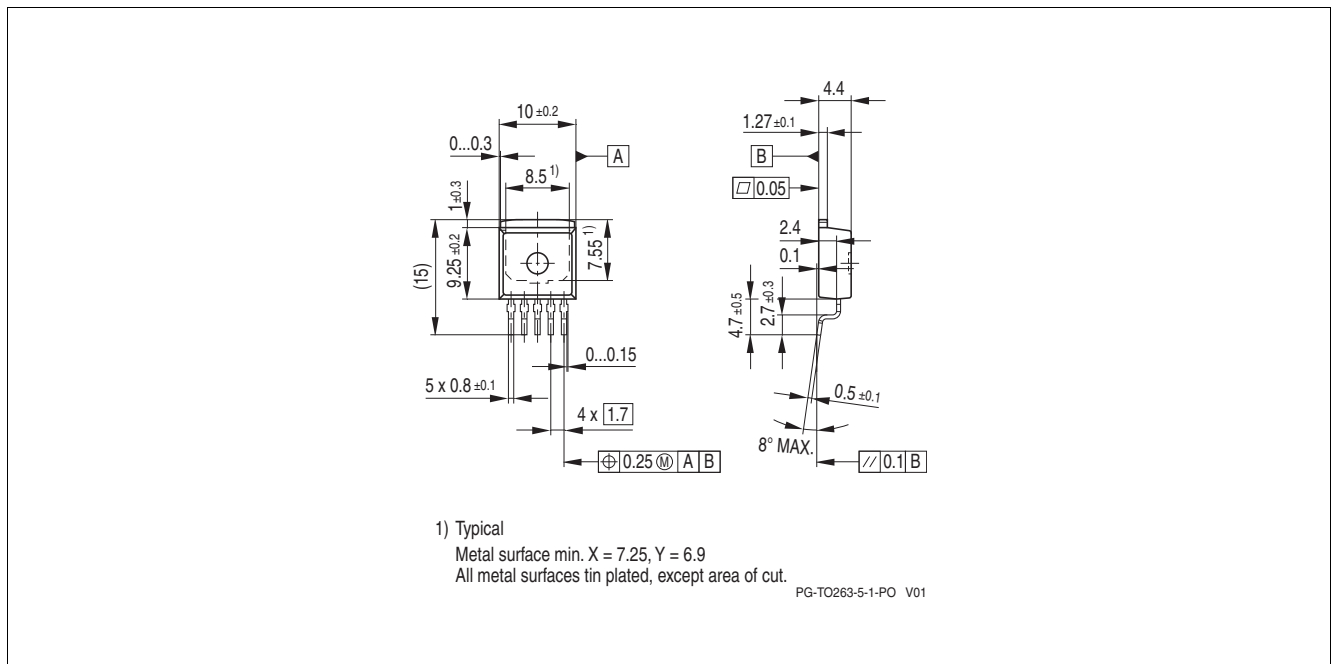

Figure 7 PG-TO263-5 1)

1) Dimensions in mm

Package information

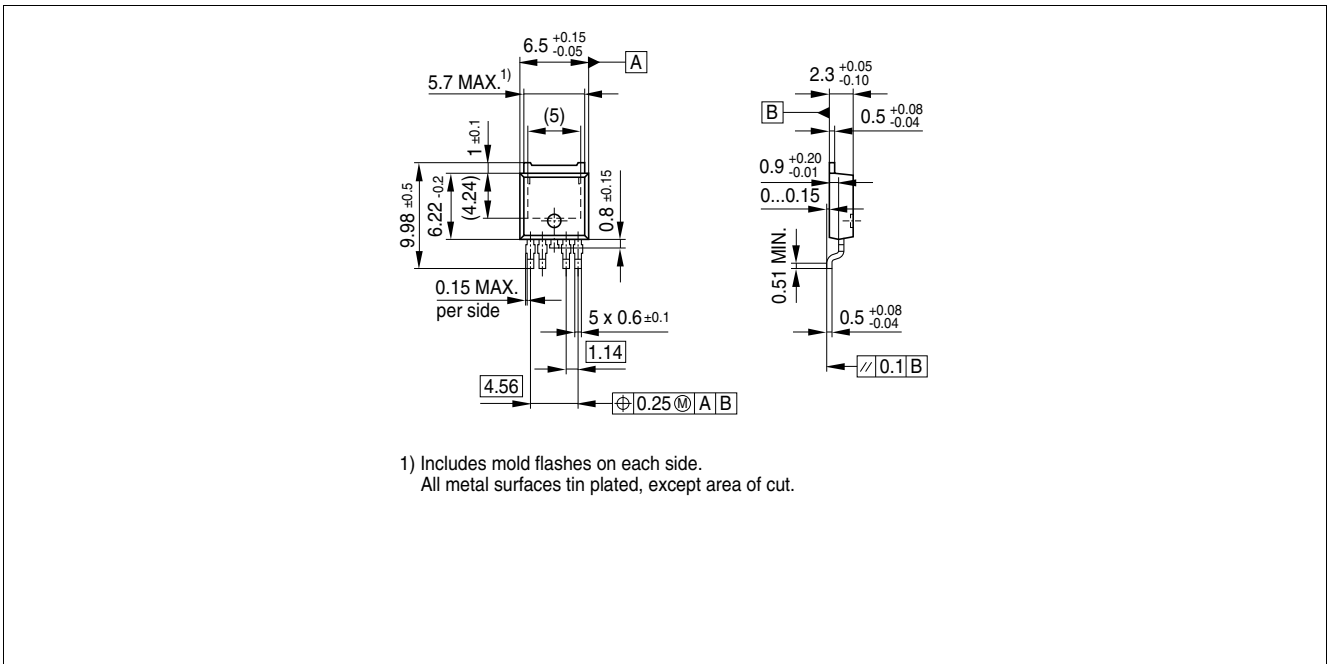

Figure 8 PG-T0252-5¹⁾

Green Product (RoHS compliant)

To meet the world-wide customer requirements for environmentally friendly products and to be compliant with government regulations the device is available as a green product. Green products are RoHS-Compliant (i.e Pb-free finish on leads and suitable for Pb-free soldering according to IPC/JEDEC J-STD-020).

Further information on packages

<https://www.infineon.com/packages>

1) Dimensions in mm

Revision History

5 Revision History

Revision	Date	Changes
2.81	2019-05-22	Updated layout (OPTIREG)
2.80	2018-01-10	Deleted obsolete products: TLE4276V50, TLE4276V85, TLE4276V10, TLE4276SV50, TLE4276SV85, TLE4276GV85 and TLE4276GV10 Updated Template

Trademarks

All referenced product or service names and trademarks are the property of their respective owners.

Edition 2019-05-22

Published by

Infineon Technologies AG

81726 Munich, Germany

© 2019 Infineon Technologies AG.

All Rights Reserved.

Do you have a question about any aspect of this document?

Email: erratum@infineon.com

Document reference

Z8F55294382

IMPORTANT NOTICE

The information given in this document shall in no event be regarded as a guarantee of conditions or characteristics ("Beschaffheitsgarantie").

With respect to any examples, hints or any typical values stated herein and/or any information regarding the application of the product, Infineon Technologies hereby disclaims any and all warranties and liabilities of any kind, including without limitation warranties of non-infringement of intellectual property rights of any third party.

In addition, any information given in this document is subject to customer's compliance with its obligations stated in this document and any applicable legal requirements, norms and standards concerning customer's products and any use of the product of Infineon Technologies in customer's applications.

The data contained in this document is exclusively intended for technically trained staff. It is the responsibility of customer's technical departments to evaluate the suitability of the product for the intended application and the completeness of the product information given in this document with respect to such application.

For further information on technology, delivery terms and conditions and prices, please contact the nearest Infineon Technologies Office (www.infineon.com).

WARNINGS

Due to technical requirements products may contain dangerous substances. For information on the types in question please contact your nearest Infineon Technologies office.

Except as otherwise explicitly approved by Infineon Technologies in a written document signed by authorized representatives of Infineon Technologies, Infineon Technologies' products may not be used in any applications where a failure of the product or any consequences of the use thereof can reasonably be expected to result in personal injury.