

## Features

- \* Low operating :3.3V
- \* Ultra low capacitance: 1.0 pF typical
- \* Ultra low leakage: nA leel
- \* Low clamping voltage
- \* Protects one power line or data line
- \* Complies with following standards:
  - IEC 61000-4-2 (ESD) immunity test  
Air discharge: ±30kV  
Contact discharge: ±30kV
  - IEC61000-4-4 (EFT) 40A (5/50ns)
- \* RoHS Compliant

## Mechanical Characteristics

- \* Package: SOD\_323
- \* Lead Finish: Matte Tin
- \* Case Material: “Green” Molding Compound.
- \* UL Flammability Classification Rating 94V-0
- \* Moisture Sensitivity: Level 3 per J-STD-020
- \* Terminal Connections: See Diagram Below

## Applications

- \* USB Ports
- \* Smart Phones
- \* Wireless Systems
- \* Ethernet 10/100/1000 Base T

## Ordering Information

Part Number	Qty per Reel	Reel Size
SP4020-01FTG-C-TP	3000	7"

## Dimensions and Pin Configuration

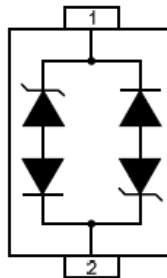

**Absolute Maximum Ratings** (Tamb=25°C unless otherwise specified)

Parameter	Symbol	Value	Unit
ESD per IEC 61000-4-2 (Air)	VESD	±30	kV
ESD per IEC 61000-4-2 (Contact)		±30	
Operating Temperature Range	TJ	-55 to +125	°C
Storage Temperature Range	Tstg	-55 to +150	°C

**Electrical Characteristics** (TA=25°C unless otherwise specified)

Symbol	Parameter
V <sub>RWM</sub>	Nominal Reverse Working Voltage
I <sub>R</sub>	Reverse Leakage Current @ V <sub>RWM</sub>
V <sub>BR</sub>	Reverse Breakdown Voltage @ I <sub>T</sub>
I <sub>T</sub>	Test Current for Reverse Breakdown
V <sub>C</sub>	Clamping Voltage @ I <sub>PP</sub>
I <sub>PP</sub>	Maximum Peak Pulse Current
C <sub>ESD</sub>	Parasitic Capacitance
V <sub>R</sub>	Reverse Voltage
f	Small Signal Frequency

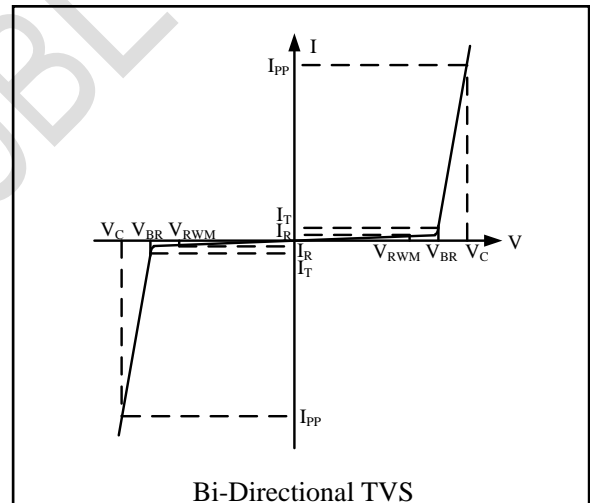

Parameter	Symbol	Test Condition	Min	Typ	Max	Unit
Reverse Working Voltage	V <sub>RWM</sub>				3.3	V
Breakdown Voltage	V <sub>BR</sub>	I <sub>T</sub> = 1mA	3.5			V
Reverse Leakage Current	I <sub>R</sub>	V <sub>RWM</sub> = 3.3V			0.2	μA
Clamping Voltage	V <sub>C</sub>	I <sub>PP</sub> = 1A (8 x 20μs pulse)		6.5	9	V
Clamping Voltage	V <sub>C</sub>	I <sub>PP</sub> = 22A (8 x 20us pulse)		17	21	V
Junction Capacitance	C <sub>J</sub>	V <sub>R</sub> = 0V, f = 1MHz		1		pF

**Electrical Characteristics ( $T_A=25^\circ\text{C}$  unless otherwise specified)**

**Fig1. 8/20 $\mu\text{s}$  Pulse Waveform**

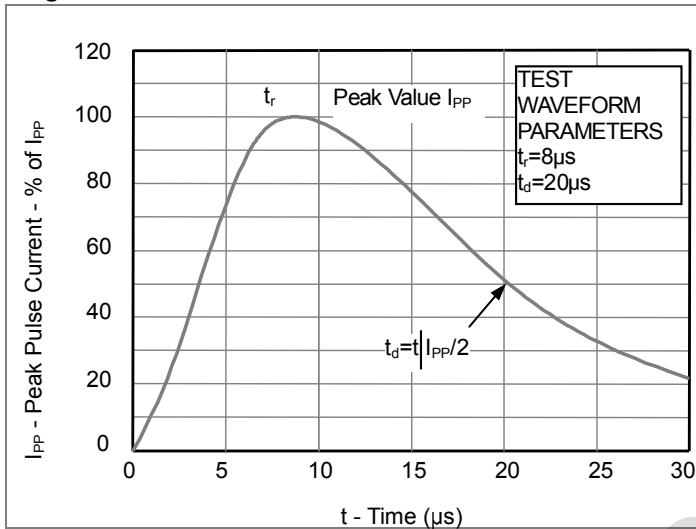

**Fig2. ESD Pulse Waveform (according to IEC 61000-4-2)**

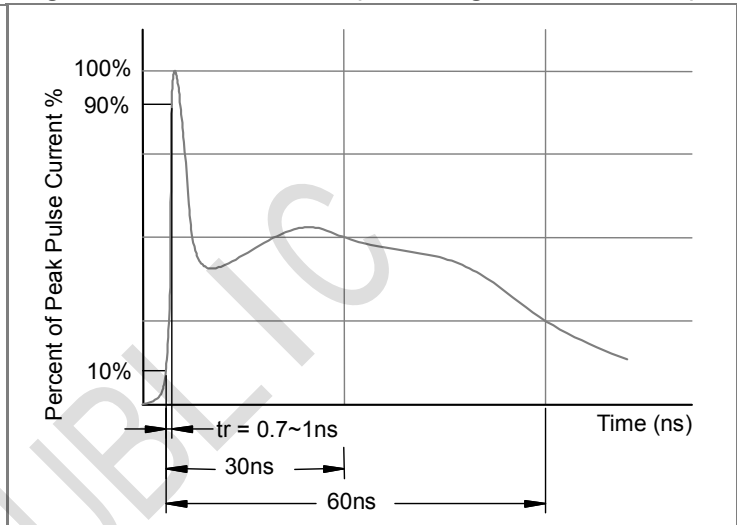

**Fig3. Power Derating Curve**

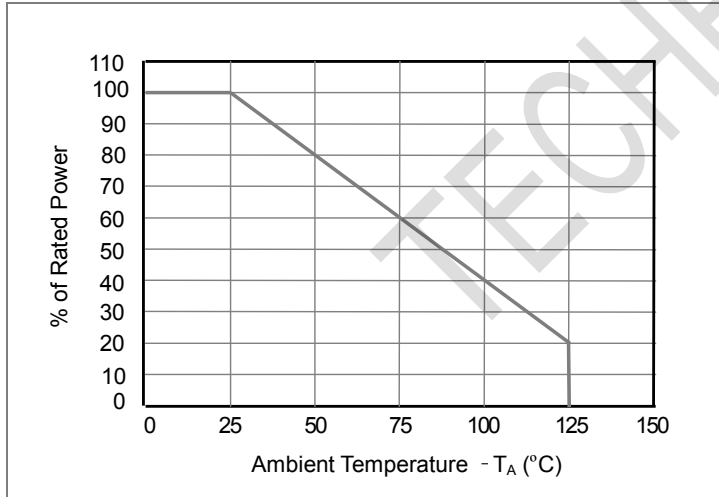

### Outline Drawing - SOD-323

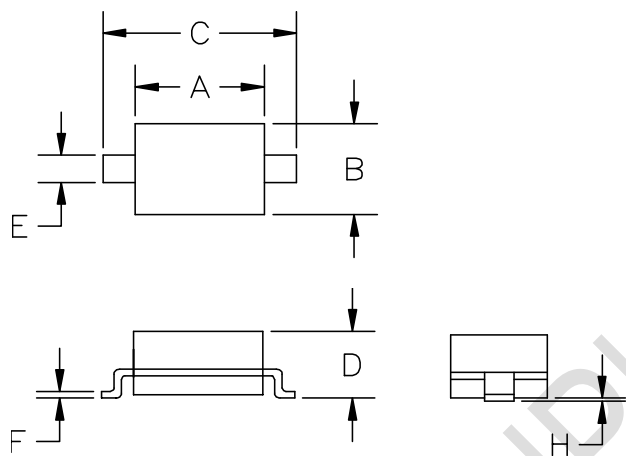

SYM	DIMENSIONS			
	MILLIMETERS		INCHES	
	MIN	MAX	MIN	MAX
A	1.50	1.80	0.060	0.071
B	1.20	1.40	0.045	0.054
C	2.30	2.70	0.090	0.107
D	-	1.10	-	0.043
E	0.30	0.40	0.012	0.016
F	0.10	0.25	0.004	0.010
H	-	0.10	-	0.004

### Land Pattern - SOD-323

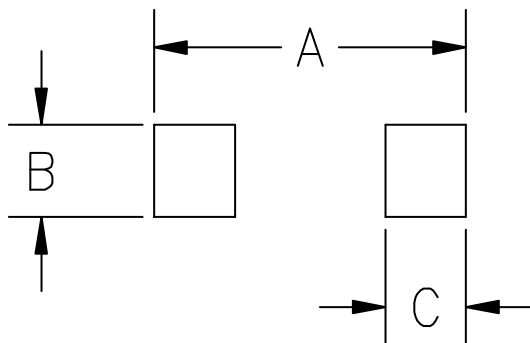

SYM	DIMENSIONS	
	MILLIMETERS	INCHES
A	3.15	0.120
B	0.80	0.031
C	0.80	0.031