



**DESCRIPTION:**

**120W AC-DC DIN RAIL Power Supply**

The rated output power of TPR/NDR-U120-XS series is 120W, input voltage range: 90-264VAC, output voltage : 12V, 24V, 48V, High reliability, precision, efficiency, ultra-small size, stable output voltage and etc., with short circuit & overload protection, Widely used in telecommunications, industrial control, instrument, data acquisition, signal control, New Energy, Security, and other electronic systems.

**FEATURES**

AC input : 90VAC-264VAC, DC input: 127-370VDC	High efficiency up to 88%	Operating temperature: -20°C~70°C
Mounting track: TS-35/7.5 or TS-35/15	Protection: short circuit, over-load, over-voltage, over-temperature	Mini width: 45mm
RoHS compliant	High reliability, efficiency, 100% full load burn-in test	Built-in current limiting circuit capacitors

**SELECTION GUIDE**

Part Number	Input Voltage			Output				Efficiency @25°C, (Typ) %
	(VAC)		(VDC)	Voltage (VDC)	Pre-set voltage @25°C(V)	Current (A)	Rated power(W)	
	Rated	Range	Range					
TPR/NDR-U120-12S	220	90-264	127-370	12	12.00-12.10	10	120	85
TPR/NDR-U120-24S	220	90-264	127-370	24	24.00-24.20	5	120	88
TPR/NDR-U120-48S	220	90-264	127-370	48	48.0-48.40	2.5	120	88

All specifications typical at TA=25°C, nominal input voltage and rated output current unless otherwise specified.

without Built-in active PFC

**OUTPUT CHARACTERISTICS**

Conditions	Conditions	Parameter
Output voltage regulation	12V output voltage	12-14V
	24V output voltage	24-28V
	48V output voltage	48-56V
Rated Output current	12V output voltage	10A at 12V
		9A at 14V
	24V output voltage	5A at 24V
		4.5A at 28V
	48V output voltage	2.5A at 48V
		2.25A at 56V
Rated Output power	12V output voltage	120W/12V, 126W/14V
	24V output voltage	120W/24V, 126W/28V
	48V output voltage	120W/48V, 126W/56V
Ripple&Noise 0<Ta≤70°C	12V 24V output voltage	120mVp-p
	48V output voltage	240mVp-p
Ripple&Noise -20<Ta≤0°C	12V 24V output voltage	240mVp-p
	48V output voltage	480mVp-p
Capacitive load capacity	12V output voltage	5000uF
	24V output voltage	3500uF
	48V output voltage	1250uF
Line regulation @-20~70°C		± 0.5%
Load regulation @-20~70°C		± 1%
Temp. coefficient @-20~70°C		± 0.03%/°C
Set-up time @25°C	≤2500mS@115Vac input    ≤1200mS@(230Vac input, Full load)	
Hold-up time @25°C	≥10mS@115Vac input    ≥20mS@(230Vac input, Full load)	
Overshoot&Undershoot		<5.0%

## INPUT CHARACTERISTICS

Conditions	Parameter
Rated Input voltage range	100VAC~240VAC
Input voltage range	90VAC~264 VAC
input voltage range	127VDC-370VDC
Frequency Range	47Hz~63Hz
Set-up voltage @-20~70°C	90 VAC (refer to the derating curve) <120VDC at 12 ,<127VDC at 24V ,48V
Input current @25°C	<2.7 A/115VAC at 12V,<2.25 A/115VAC at 24V,<2.25 A/115VAC at 24V ,1.12A/127VDC ,0.46A/300VDC
Inrush current @25°C	<20A@115 Vac input <35A@230Vac input

## PROTECTION @-20~70°C

Conditions	Parameter	Notes
Over-Load (12Voutput)	10.5~13A	Limit output current
Over-Load (24Voutput)	5.25~6.5A	
Over-Load (48Voutput)	2.75~3.25A	
Over-voltage (12Voutput)	15~18V	Protection type:Locked, auto recovery
Over-voltage (24Voutput)	29~33V	
Over-voltage (48Voutput)	58~63V	
Over-temperature	Ambient at 83°C&rated input,full-load output	Protection type: power-off , recovery after restart
Output short circuit protection	Long-term model , auto recovery	

## ENVIRONMENT CHARACTERISTICS

Conditions	Parameter
Operating amb. Temp.&Humi. (12V output)	-20°C~70°C; 20%~90%RH No condensing 45°C~70°C 2.5W/°C derating
Operating amb. Temp.&Humi. (24V output)	-20°C~70°C; 20%~90%RH No condensing 50°C~70°C 3W/°C derating -10°C~-20°C 2.4W/°C derating
Operating amb. Temp.&Humi. (48V output)	-20°C~70°C; 20%~90%RH No condensing 115VAC 50°C~70°C 3W/°C derating,230VAC 55°C~70°C4W/°C derating
Storage Temp. & Humi.	-40°C~85°C; 5%~95%RH No condensing
Vibration	10 ~ 500Hz, 2G, 10min./1cycle, period for60min. each along X,Y, Z axes IEC 60068-2-6
Pulse	20G/11mS pulse ,3 times at each X,Y,Z axes IEC 60068-2-27
Altitude	6000m

## SAFETY&EMC STANDARDS @25°C

Conditions	Parameter
Safety Standards	GB4943 ,EN60950 (for reference)
Withstand Voltage	12V : I/P-O/P:3.0KVac/10mA; I/P-FG:2KVac/10mA; O/P-FG:0.5KVdc/10mA test time:1min. 24V48V : I/P-O/P:3.0KVac/10mA; I/P-FG:1.5KVac/10mA; O/P-FG:0.5KVdc/20mA test time:1min.
Isolation resistance	12V : I/P-O/P: 10M ohms; I/P-FG : 10M ohms; O/P-FG : 10M ohms 24V48V : I/P-O/P: 100M ohms; I/P-FG : 100M ohms; O/P-FG : 100M ohms
Grounding test	Test condition: 32A / 1min.; Grounding resistance: <0.1 ohms.
Leakage Current @ 25°C	I/P-Grounding≤3.5mA; I/P-O/P ≤0.25mA (264Vac input, 63Hz)
EMC emission	Compliance to EN55022, EN55024, FCC PART 15 CLASS B
EMC immunity	Compliance to EN61000-4-2,3,4,5,6,11 heavy industry level
Harmaonic current	EN61000-3-2, CLASS A

**OTHERS**

Conditions	Parameter
Cooling method	Cooling by free air flow
Dimension (L*W*H)	45*124*119mm
Net Weight	0.59kg
Series function	yes
DC OK LED	Green light

**RELIABILITY CHARACTERISTICS**

Conditions	Parameter
MTBF	500, 000Hrs AT 25°C, MIL-217 Method 2 Components Stress Method

**MECHANICAL DIMENSIONS**

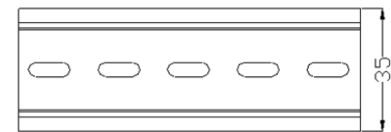
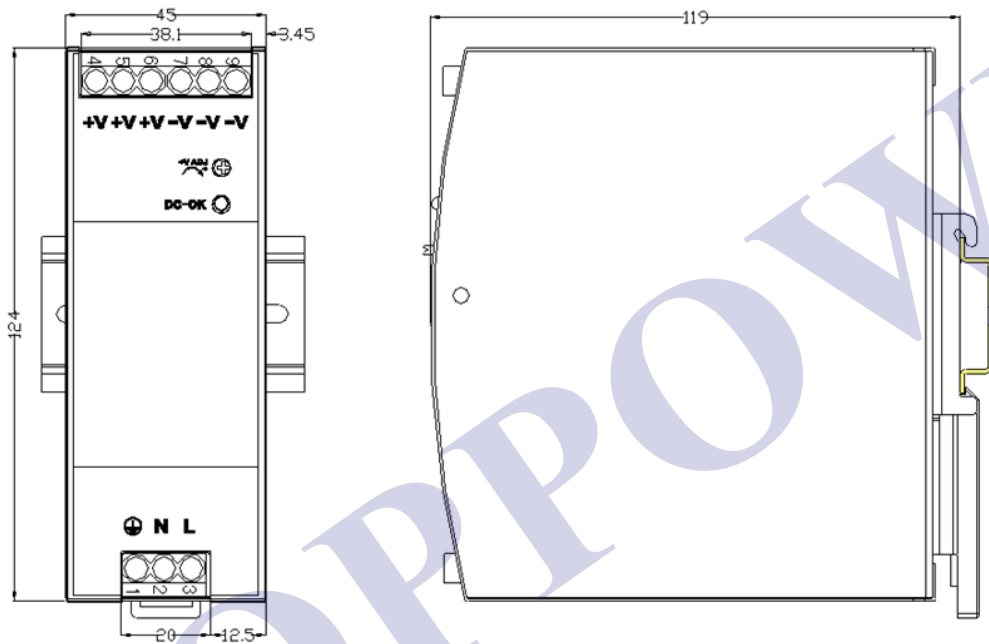

Mounting way: TS35/7.5 or TS35/15

**1.AC terminal blocks installation information**

Terminal No.	Function	Wire Spec	Recommended torque
1	⊕	20~10AWG	5Nm
2	N		
3	L		

**2.DC terminal blocks installation information**

Terminal No.	Function	Wire Spec	Recommended torque
4 /5/6	+V	20~10AWG	5Nm
7/8/9	-V		

	AC/DC Terminal blocks
Type	Screw terminal blocks
Solid Wire	0.5-6mm <sup>2</sup>
Strand Wire	0.5-4mm <sup>2</sup>
Wire Spec	AWG20-10
Max Wire Diameter	2.8mm
Recommended stripping length	7mm
Screwdriver	3.5mm Straight or Cross Screwdriver
Recommended Torque	0.5NM

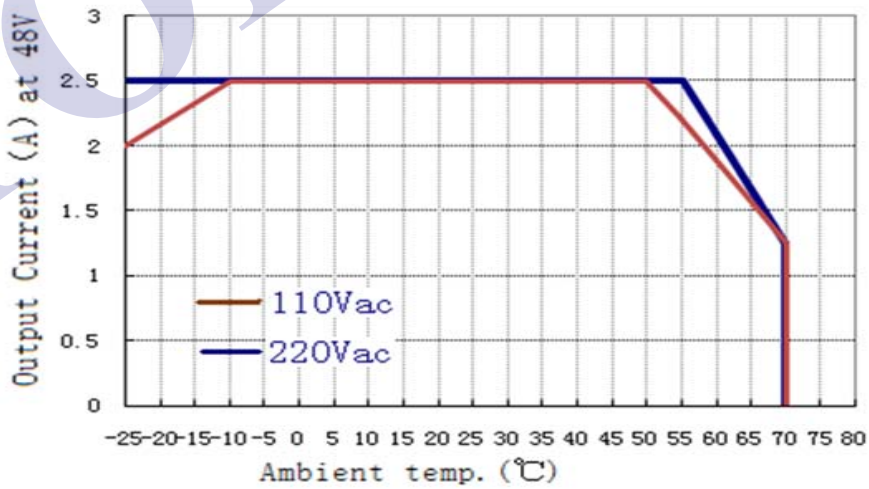
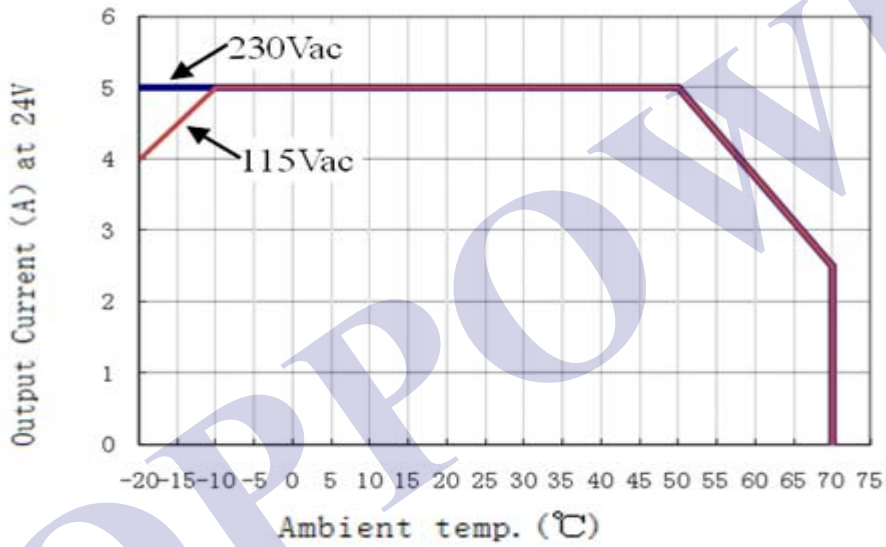
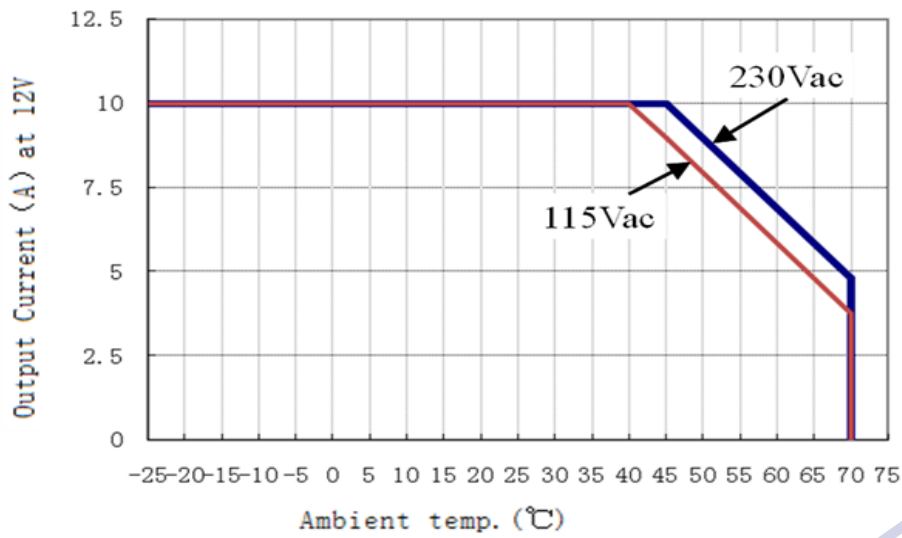

— Short time working  
— Continuous working

**MOUNTING METHOD INSTRUCTION**

A1 is recommended output current , A2 is the allowed max output current (PSU lifetime is around half of A1)

**12V output**

**Mounting 1:**

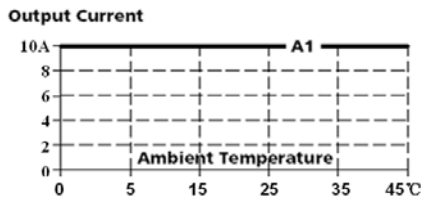
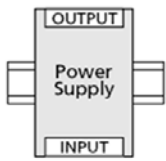

**Mounting 2:**

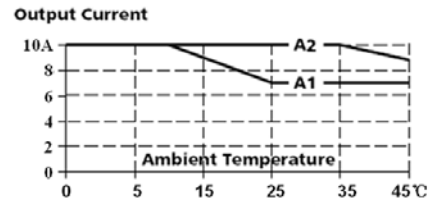
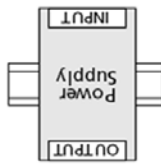

**Mounting 3:**

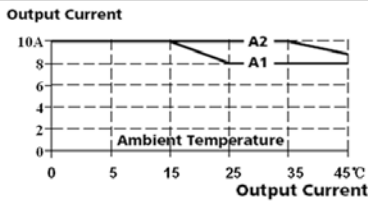
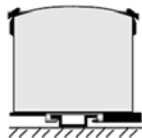

**Mounting 4:**

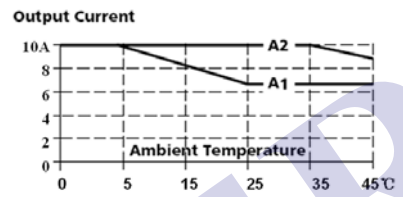
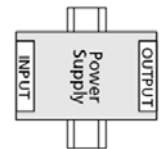

**Mounting 5:**

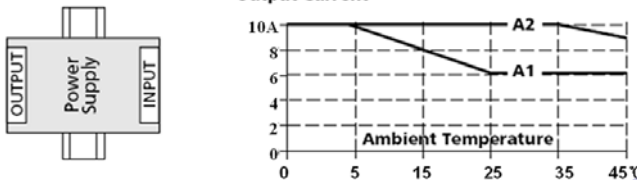

**24V output**

**Mounting 1:**

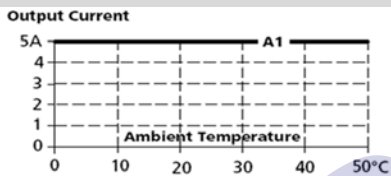
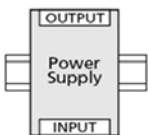

**Mounting 2:**

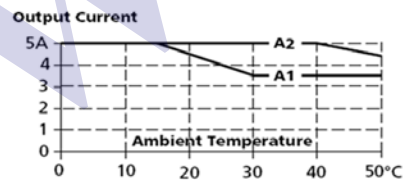

**Mounting 3:**

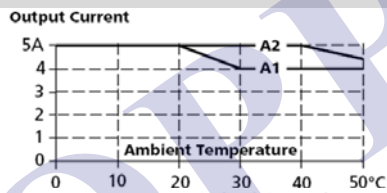
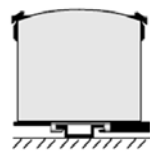

**Mounting 4:**

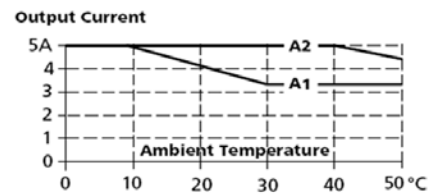
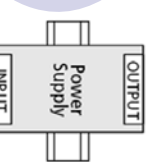

**Mounting 5:**

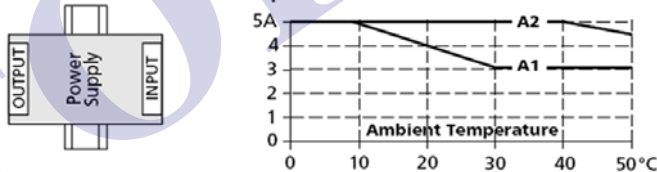

**48V output**

**Mounting 1:**

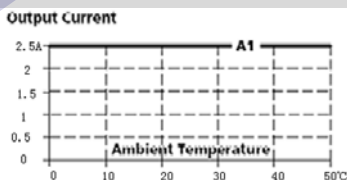
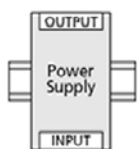

**Mounting 2:**

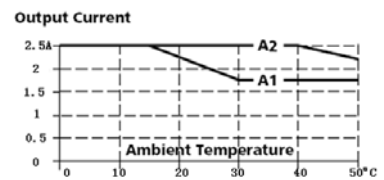
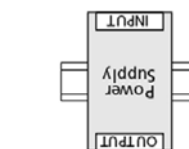

**Mounting 3:**

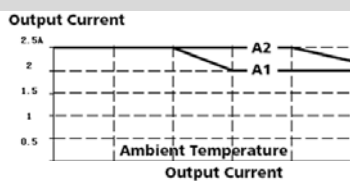
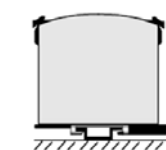

**Mounting 4:**

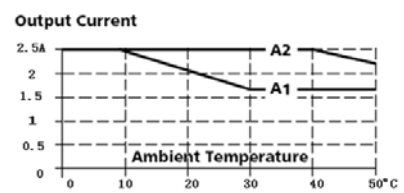
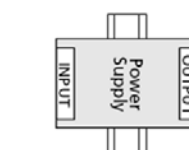

**Mounting 5:**

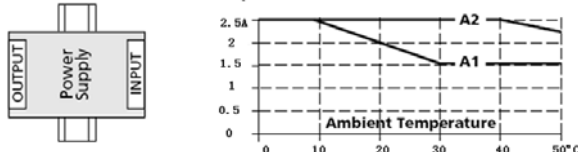

**BLOCK DIAGRAM**

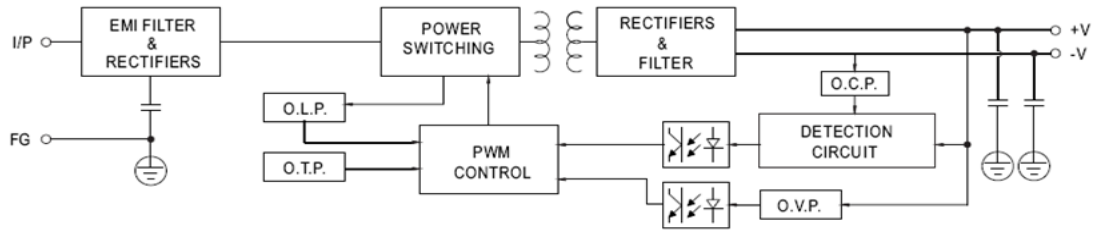

**MODEL SELECTION**

**TP R / NDR - U120 - X S**

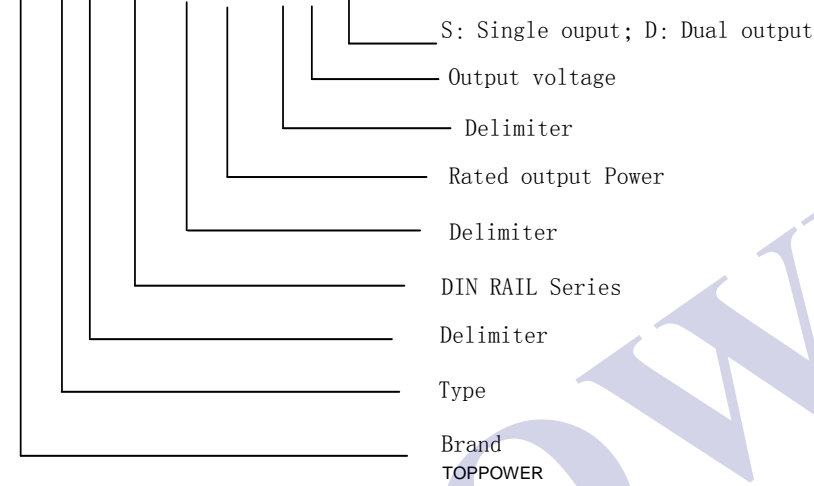

TOPPOWER