



The Future of Analog IC Technology®

EV3306-G-00A

700kHz Synchronous Boost WLED Driver Evaluation Board

DESCRIPTION

The MP3306 is a step-up converter designed for driving white LEDs from 3V to 12V power supply. The MP3306 uses current mode, fixed frequency architecture to regulate the LED current, which is measured through an external high-side current sense resistor. The low 202mV feedback voltage and synchronous rectification reduces power loss and improves efficiency.

The MP3306 is turned off if an over-voltage condition is present due to an open circuit condition. The output disconnect feature allows the output to be completely discharged. TheMP3306 includes under-voltage lockout, current limiting, output short protection and thermal overload protection.

The MP3306 is available in small 12-pin QFN (2mm x 2mm) package.

ELECTRICAL SPECIFICATIONS

Parameter	Symbol	Value	Units
Input Voltage	V_{IN}	3-12	V
Output Voltage	V_{out}	<30	V
LED String		1	
LED Current	I_{LED}	20	mA

FEATURES

- 3V~12V Input Voltage
- Analog Dimming and PWM Dimming
- Output-to-Input Disconnect in Shutdown Mode
- Programmable Open Load Shutdown
- Output Short Protection
- Low 202mV Feedback Voltage with +/-3% accuracy
- UVLO, Thermal Shutdown
- Available in 2mm x 2mm QFN12 Package

APPLICATIONS

- Smart Phone, MID, PDA
- Digital Still Cameras
- Small LCD Displays

All MPS parts are lead-free, halogen free, and adhere to the RoHS directive. For MPS green status, please visit MPS website under Quality Assurance.

"MPS" and "The Future of Analog IC Technology" are Registered Trademarks of Monolithic Power Systems, Inc.

EV3306-G-00A EVALUATION BOARD

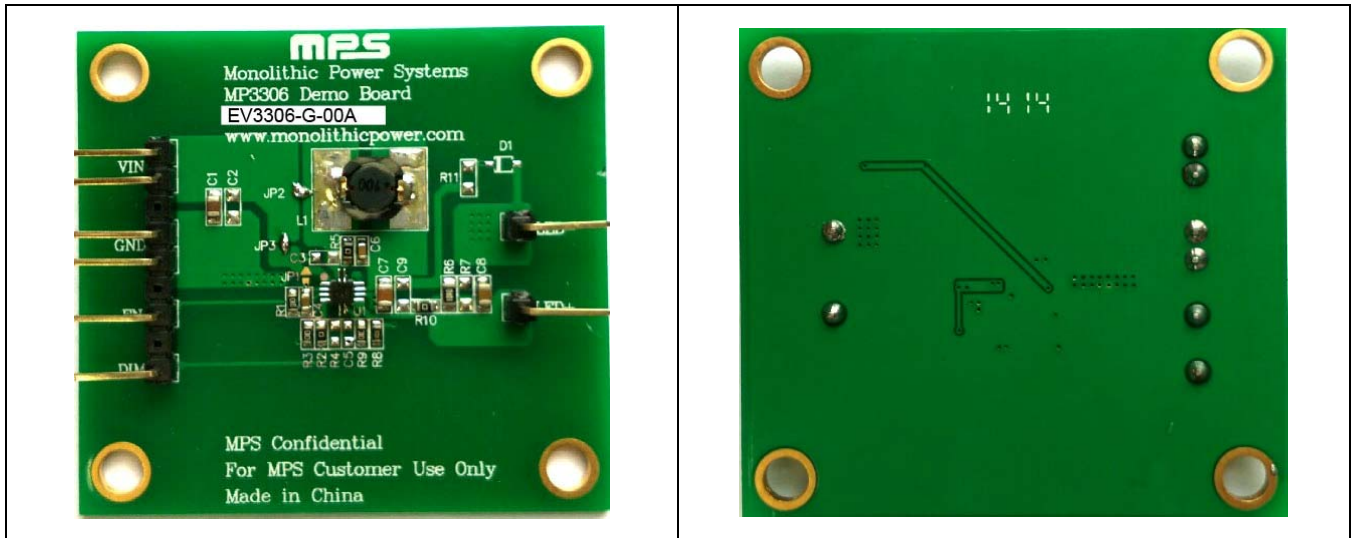

(L x W x H) 5.0cm x 4.6cm x 0.46cm

Board Number	MPS IC Number
EV3306-G-00A	MP3306EG

EVALUATION BOARD SCHEMATIC

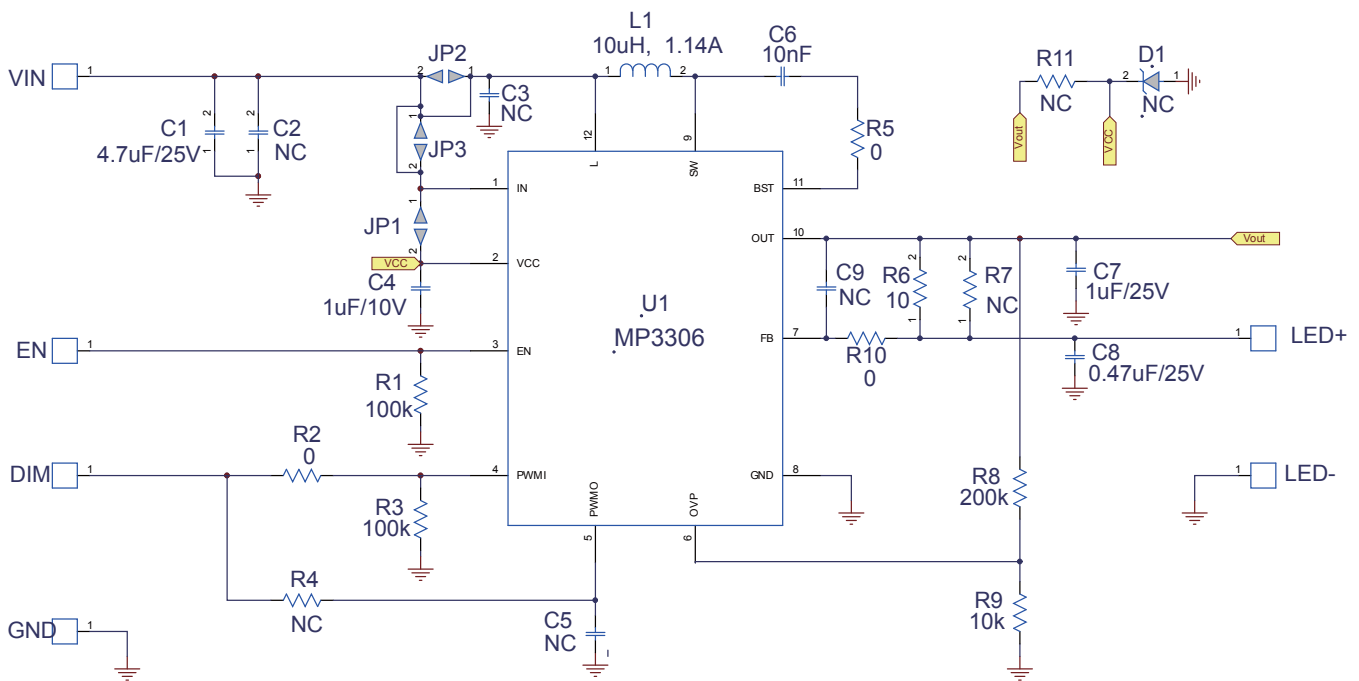

EV3306-G-00A BILL OF MATERIALS

Qty	Ref	Value	Description	Package	Manufacturer	Part Number
1	C1	4.7 μ F	Ceramic capacitor, X5R, 16V	0805	TDK	C2012X5R1C475K
2	C2, C9	NC	Ceramic capacitor	0805		
2	C3, C5	NC	Ceramic capacitor	0603		
1	C4	1 μ F	Ceramic capacitor, X5R, 6.3V	0603	muRata	GRM188R60J1105KA01D
1	C6	10nF	Ceramic capacitor, 25V	0603	muRata	GRM188R71E103JA01D
1	C7	1 μ F	Ceramic capacitor, X7R, 25V	0805	TDK	C2012X7R1E105K
1	C8	0.47 μ F	Ceramic capacitor, X7R, 25V	0805	muRata	GRM21BR71E474KA01L
1	R1, R3	100k Ω	Film resistor, 1%	0603	Yageo	RC0603FR-07100KL
3	R2, R5, R10	0	Film resistor, 1%	0603	Yageo	RC0603FR-070L
3	R4, R7, R11	NC	resistor	0603		
1	R6	10 Ω	Film resistor, 1%	0805	Yageo	RC0805FR-0710RL
1	R8	200k Ω	Film resistor, 1%	0603	Yageo	RC0603FR-07200KL
1	R9	10k Ω	Film resistor, 1%	0603	Yageo	RC0603FR-0710KL
1	JP1	NC				
2	JP2, JP3	Short				
1	D1	NC		SMD		
1	L	10 μ H	Rdcr=59m Ω , Isat=1.14A	SMD	TOKO	D63LCB-A921CY-100M=P3
1	U1	MP3306		QFN12, 2mm*2mm	MPS	

EVB TEST RESULTS

Performance waveforms are tested on the evaluation board.
V_{IN}=5V, V_{EN}=5V, 8 LEDs in series, 20mA, unless otherwise noted.

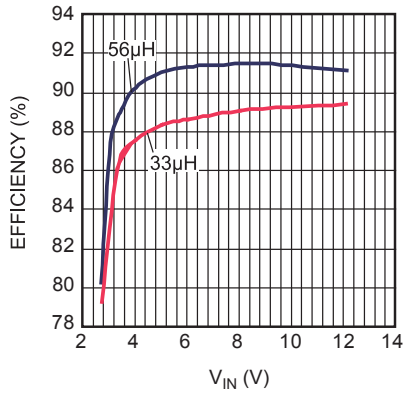
Efficiency

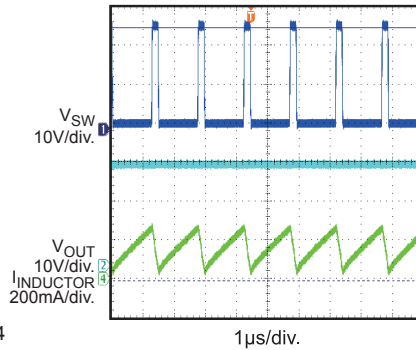
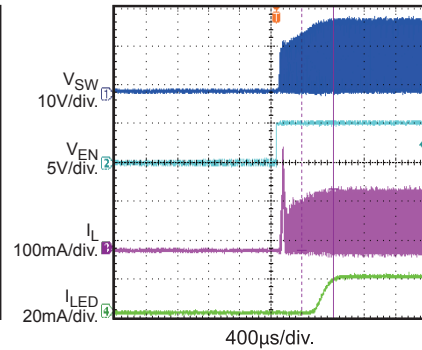
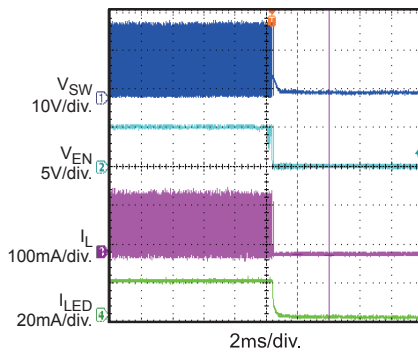
Steady State

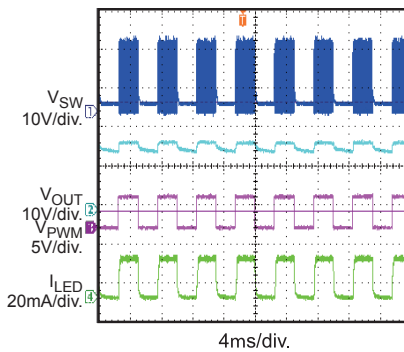
 V_{IN} = 3V

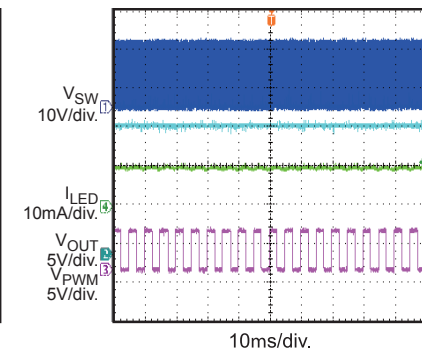
EN Startup

EN Shutdown

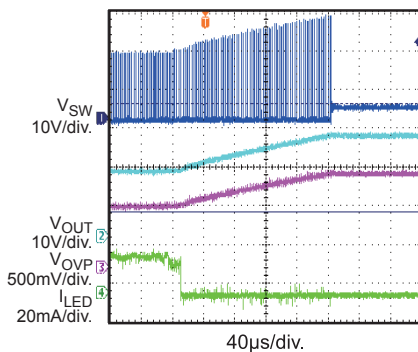
PWM Dimming

 f_{PWM} = 200Hz, D = 50%

Analog Dimming

 f_{PWM} = 200Hz, C_{PWMO} = 470nF, D = 50%

Open LED Protection

Open LED @ Working

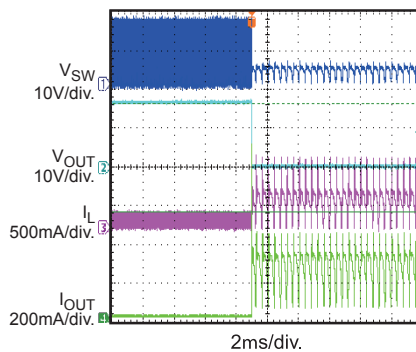
Short LED Protection

Short LED+ to LED-

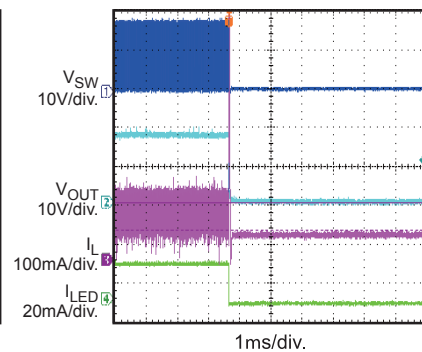
Short V_{OUT} to GND Protection

 Short V_{OUT} to GND

PRINTED CIRCUIT BOARD LAYOUT

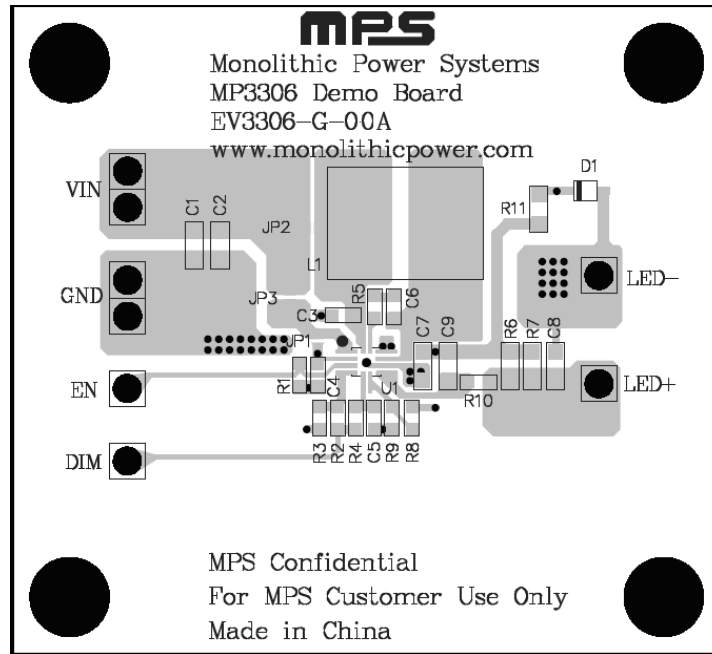

Figure 1—Top Layer

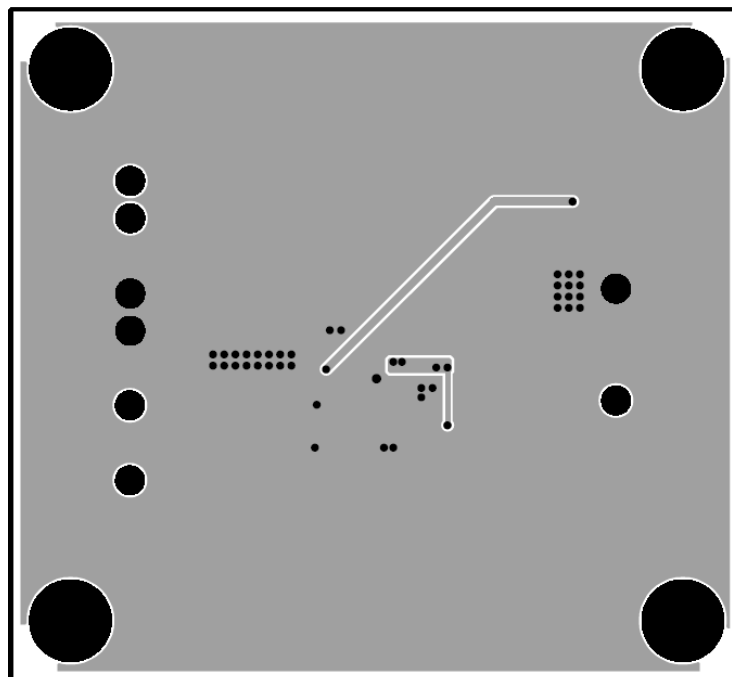

Figure 2—Bottom Layer

QUICK START GUIDE

1. Connect the positive and negative terminals of the power supply (3V ~ 12V) to the VIN and GND pins on the EV board, respectively.
2. LED string is connected to LED+ and LED- terminal respectively;
3. Drive EN pin high to enable the MP3306.
4. The DIM terminal is used for Analog/PWM dimming. When LPF capacitor is place at the PWO pin, MP3306 works in analog dimming mode by filtering the input PMW pulse. When PWM pin is float, MP3306 works in PWM dimming mode.
5. The LED current is set by the resistor at FB pin.
6. MP3306 has a N-channel MOS, which is used to accomplish short Vout to GND protection and disconnecting Vout from Vin at shutdown mode. if don't need this function, it can be disabled by short the JP2.

NOTICE: The information in this document is subject to change without notice. Please contact MPS for current specifications. Users should warrant and guarantee that third party Intellectual Property rights are not infringed upon when integrating MPS products into any application. MPS will not assume any legal responsibility for any said applications.