



MAGNETIC POWDER CORES



MAGNETIC
POWDER CORES

Offices and Factories in Korea

Headquarters & Incheon Factory

620-8 Namchon-dong, Namdong-gu,
Incheon, Korea
Tel: 82-32-450-8770 Fax: 82-32-450-8870

International Business Center

4FL, Kukje Bldg, 127-1, Nonhyun-dong, Kangnam-gu,
Seoul, Korea
Tel: 82-2-512-3793 Fax: 82-2-512-3214

Pyeongtaek Factory

148-40, Goryeom-ri, Cheongbuk-myeon, Pyeongtaek-si,
Gyeonggi-do, Korea
Tel: 82-31-683-2466 Fax: 82-31-683-2465

Cheongju Factory

8-8 Poongjung-ri, Naesu-eup, Cheongwon-gun,
Chungbuk, Korea
Tel: 82-43-213-8801 Fax: 82-43-213-8807

Offices and Factories Overseas

China

Weihai Factory

Changxing Road, First Industrial Complex, Huanshan RD,
Economic Technological Development Zone,
Weihai City, Shandong Province, China
Tel: 86-631-596-5931 Fax: 86-631-596-8160

Dongguan Factory

Huangkeng Industrial Area, Shilongkeng Village,
LiaoBu Town, Dongguan City, Guangdong Province, China
Tel: 86-769-8352-1800 Fax: 86-769-8352-1803

Japan

Tokyo Office

Bansui Ken Bldg, 5F, Toranomom 1-6-6,
Minato-Ku Tokyo, Japan 105-0001
Tel: 81-3-5512-5380 Fax: 81-3-5501-3234



CO-120120

Innovative Technological Advancements

Move forward with Chang Sung Corporation. We are one of the main suppliers of cutting edge products to all our customers at the forefront of the next generation in energy solutions.



CSC soft magnetic powder cores are at the forefront of advanced industries

We deliver excellence in performance by always keeping our customers' specific needs in mind.

Chang Sung Corporation has been producing magnetic powder cores with sophisticated technological expertise in manufacturing metal powders since 1980. We have steadfastly made investments into our research and development program as well as our manufacturing facilities to increase our range of products and production capacity in line with the growing needs of our customers.

This has enabled Chang Sung Corporation to become a leading global player in producing soft magnetic powder cores. Today, we are well positioned to offer reliable product quality at competitive prices to meet the diverse requirements of all our clients.

Moving forward with Chang Sung Corporation to the Next Generation in Energy Solutions.

Mega Flux Cores
Fe-Si-alloy

High Flux Cores
Ni-Fe-alloy

MPP Cores
Ni-Fe-Mo-alloy powder

Sendust Cores
Fe-Si-Al alloy

What are Powder Cores?



Chang Sung Corporation's advanced technology enables us to fulfill the diverse needs of our clients for soft magnetic powder cores.

Powder cores are distributed air gap cores made from ferrous alloy powders for low losses at high frequencies. Small air gaps distributed evenly throughout the cores increase the amount of Direct Current (DC) that can be passed through the winding before core saturation occurs. Molybdenum Permalloy Powder (MPP) cores are ideal for low loss inductors such as switching regulators and noise filters. High Flux, Sendust and Mega Flux® cores are the preferred choices for Power Factor Correction (PFC), switching regulator inductors, in-line noise filters, pulse and flyback transformers and many other applications requiring low losses at high frequencies.

▼ Product Summary

Cross Sectional View

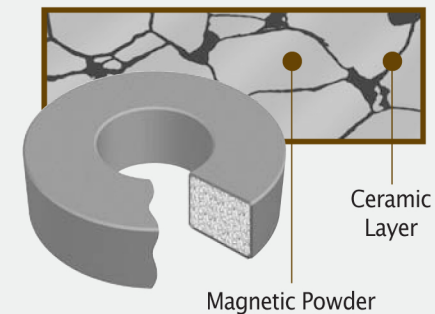

Core Materials

- MPP Core : Ni-Fe-Mo alloy
- High Flux Core : Fe-Ni alloy
- Sendust Core : Fe-Si-Al alloy
- Mega Flux® Core : Fe-Si alloy

Core Shapes

- Toroids : From 3.5mm to 165mm OD
- Special : Ellipse, Block, Cylinder, Washer, ER, U, EE, EER, EQ

Permeability

- MPP : 26, 60, 125, 147, 160, 173, 200 μ
- High Flux : 26, 60, 125, 147, 160 μ
- Sendust : 26, 60, 75, 90, 125 μ
- Mega Flux® : 26, 60, 75, 90 μ

Core Finishes

- Finish : Epoxy, Parylene-C, Plastic Case
- Color - MPP : Gray
 - High Flux : Khaki
 - Sendust : Black
 - Mega Flux® : Dark Brown

- Break-Down Voltage : 500V min.

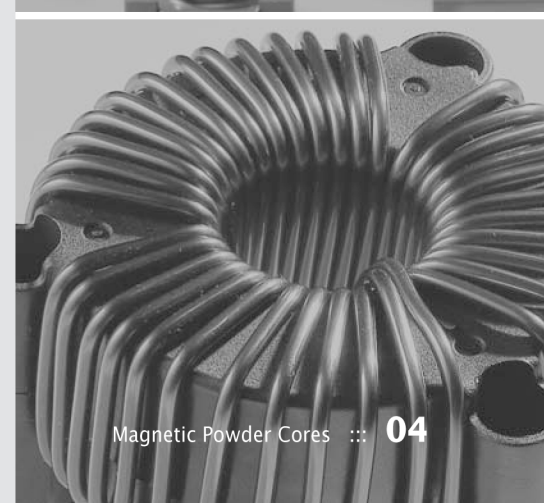
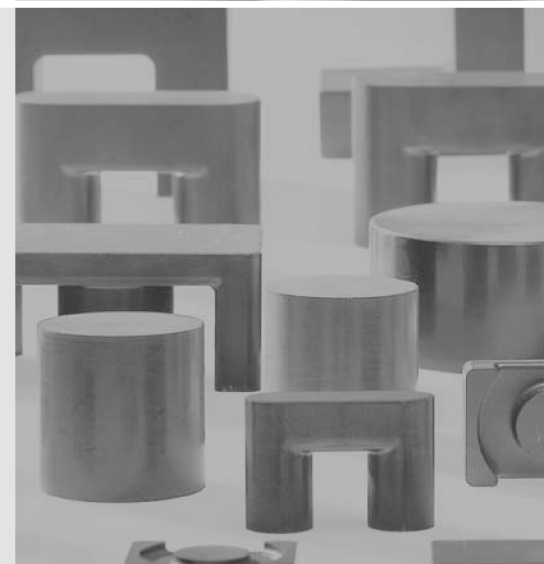
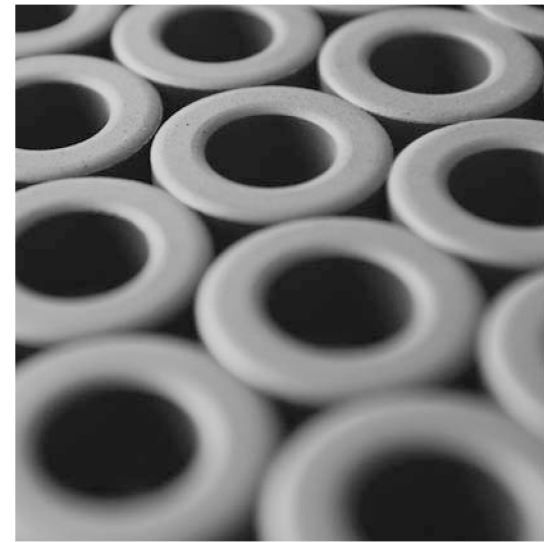

Outstanding products begin with a standardized production line and a strict quality control process

Chang Sung Corporation manufactures four types of soft magnetic powder cores including the Molybdenum Permalloy (MPP), High Flux, Sendust and Mega Flux®, which are mainly used for inductors and transformers requiring low losses and inductance stability under high DC bias conditions. A fully standardized production management system under strict quality control of the raw materials (nickel, iron, molybdenum, aluminum and silicon) enables CSC to guarantee consistent quality and thus build greater confidence in our company's product line.

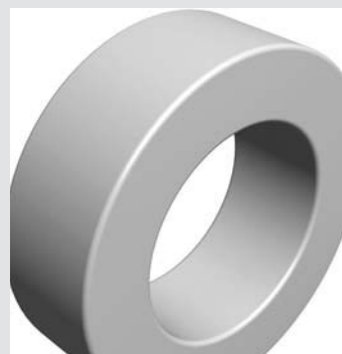

MPP

Ni-Fe-Mo alloy powder cores are made from alloy powders of nickel, iron and molybdenum.

MPP cores exhibit a highly sustainable stability in temperature and inductance under high DC magnetization or high DC Bias conditions. They offer the highest permeability among our materials and the lowest core loss compared to any other core material. MPP cores are also considered to be a premium material for direct current output inductors for SMPS including high Q filters, loading coils and EMI/RFI filters. Finished toroid cores are coated with a gray epoxy to provide dielectric protection and added physical strength.



HIGH FLUX

Ni-Fe alloy powder cores are made from alloy powders of nickel and iron.

The 15,000 Gauss saturation level of High Flux cores has a higher energy storage capability and more effective permeability when compared to the performance of gapped ferrite or powdered iron cores of a similar size. The excellent DC bias characteristics and low core losses of High Flux cores offer a reduction in size and the number of winding turns as well as superior magnetic properties. CSC High Flux cores are excellent choices for applications such as PFC reactors, switching regulator inductors, in-line noise filters, pulse transformers and flyback transformers. Finished High Flux cores are coated with a Khaki epoxy and come in a variety of shapes and sizes.



SENDUST

Fe-Si-Al alloy powder cores are made from alloy powders of iron, silicon and aluminum.

Near-zero magnetostriction makes Sendust cores ideal for eliminating audible noise in filter inductors. Core losses of Sendust cores are significantly lower than those of powdered iron cores. Especially Sendust E shapes provide a higher energy storage capability than gapped Ferrite E cores. Gap losses and eddy current losses are minimized with Sendust E cores compared to gapped ferrite E shapes. Sendust cores are a smart choice for PFC circuits. Other major applications include switching regulator inductors, In-line noise filters, pulse transformers and flyback transformers. Finished Sendust cores are coated in a black epoxy.



MEGA FLUX®

Fe-Si alloy powder cores are made from an alloy of iron and silicon.

CSC has developed new magnetic alloy powder cores for the first time in the world under the name of Mega Flux®. The innovative design of these unique cores includes a smaller size, higher current and higher energy storage capability. Mega Flux® cores have higher flux density than any other magnetic material, 16,000Gauss compared to 15,000Gauss for High Flux cores and 10,000 Gauss for Sendust cores. The extremely good DC bias characteristics provide the best solution for high end applications such as buck/boost inductors for high power supply systems, smoothing chokes for inverters and reactors for electric vehicles. Mega Flux® cores pressed with no organic binder have significantly lower core losses than powdered iron cores and Fe-Si strip cores. They also present excellent thermal properties with no thermal aging effects. Finished Mega Flux® cores are coated with a dark brown epoxy.

Comparison of Core materials

	Materials	Perm. (μ)	Bs (G)	Core Loss	DC Bias	Relative Cost	Temp. Stability	Curie Temp ($^{\circ}$ C)
Powder	MPP	14-200	7,000	Lower	Better	High	Best	450
	High Flux	26-160	15,000	Low	Best	Medium	Better	500
	Sendust	26-125	10,000	Low	Good	Low	Good	500
	Mega Flux®	26-90	16,000	Medium	Best	Low	Better	700
	Iron	10-100	10,000	High	Poor	Lowest	Poor	770
Strip	Fe-si (Gapped)		18,000	High	Best	Lowest	Good	740
	Amorphous (Gapped)		15,000	Low	Better	Medium	Good	400
	Ferrite (Gapped)		4,500	Lowest	Poor	Lowest	Poor	100~300

Permeability vs DC Bias

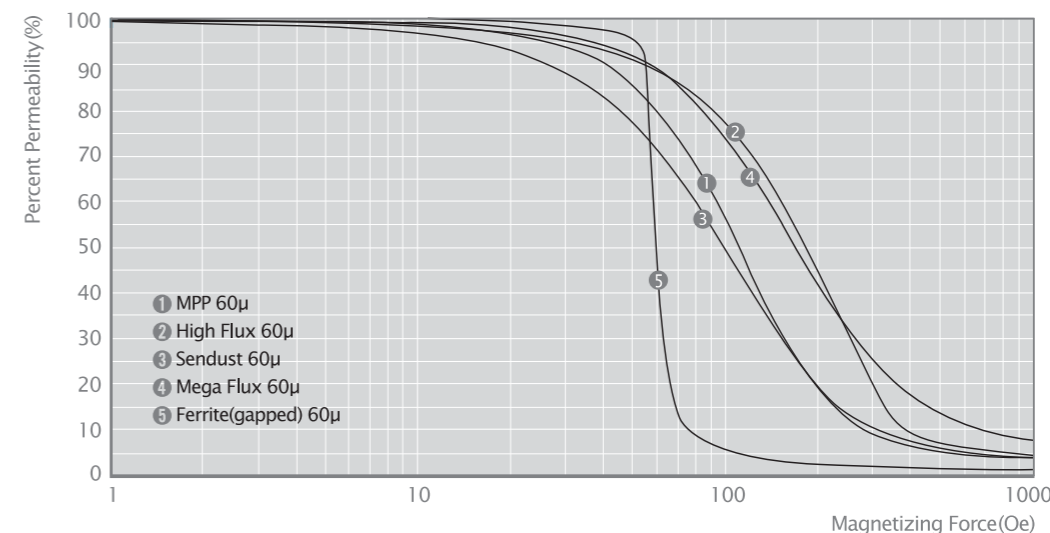

Core Loss (at 50kHz)

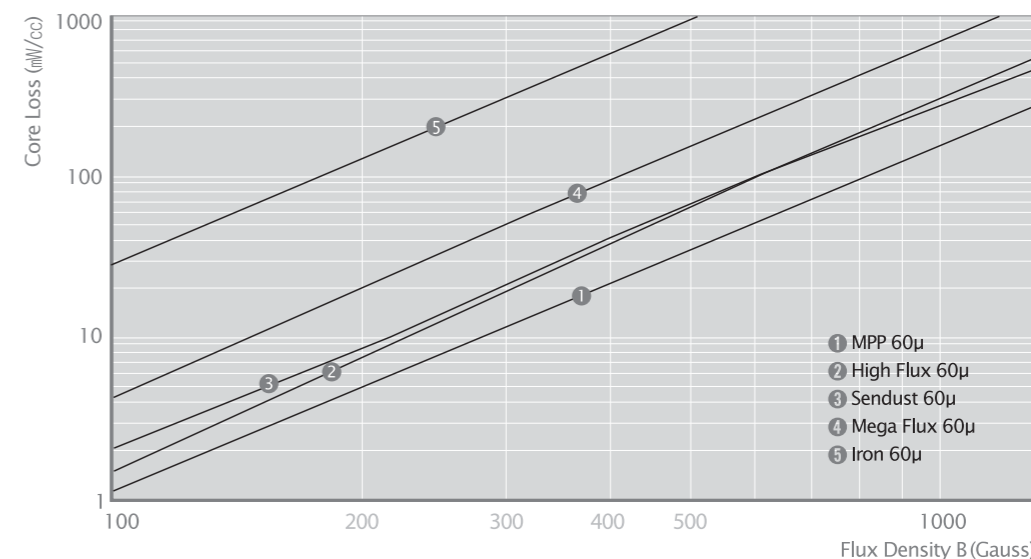

■ Magnetic Design Formulas

Inductance of a Wound Core

The inductance of a wound core at a given number of turns is calculated using the following formula.

$$L = \frac{0.4 \pi \mu N^2 A \times 10^{-2}}{\ell}$$

$$L_N = A_L \times N^2 \times 10^{-3}$$

L = inductance (μH)
 μ = core permeability
 N = number of turns
 A = effective cross section area (cm²)
 ℓ = mean magnetic path length (cm)
 L_N = Inductance at N turns (μH)
 A_L = nominal Inductance (nH/N²)

Permeability - Flux Density - Magnetizing Force

Ampere's Law and Faraday's Law show the relations of permeability, flux density and magnetizing force of a wound core.

$$H = \frac{0.4 \pi N I}{\ell} \quad \text{----- Ampere's Law}$$

$$B_{\max} = \frac{E_{\text{rms}} \times 10^8}{4.44 f A N} \quad \text{----- Faraday's Law}$$

$$\mu = \frac{B}{H}$$

H = magnetizing force (oersteds)
 N = number of turns
 I = peak magnetizing current (amperes)
 ℓ = mean magnetic path length (cm)
 B_{max} = maximum flux density (gausses)
 E_{rms} = voltage across coil (volts)
 f = frequency (hertz)

Inductance Calculation by Permeability vs DC Bias Curves

Inductor specification
 - Core : CM270125
 - Number of Windings : 22 Turns
 - Current : DC 10 Amperes

solution

a) Formula to calculate L at 0 Ampere

$$L_N = A_L \times N^2 \times 10^{-3}$$

The Nominal inductance table on page 7 shows the A_L value of CM270125 to be 157.

Therefore, L (@0A) = 157 × 22² × 0.001 = 76 (μH)

b) Determine DC magnetizing force (H) by using Ampere's law to achieve the roll off.

$$H = 0.4 \pi N I / \ell$$

$$H = 0.4 \times 3.14 \times 22 \times 10 / 6.35 = 43.5 \text{ (Oe)}$$

The magnetizing force (dc bias) is 43.5 oersteds, yielding 64% of initial permeability. See on page 11.

The inductance at 10 Ampere will decrease the inductance by 64% compared with 0 Ampere.

Therefore, L (@10A) = 76 × 0.64 = 48.6 (μH)

※ Inductance calculation by A_L vs NI Curve is also available on page 24.

Mean Magnetic Path Length

For toroidal powder cores, the effective area (A) is the same as the cross sectional area. By definition and Ampere's Law, the effective magnetic path length is the ratio of ampere-turns (NI) to the average magnetizing force. Using Ampere's Law and averaging the magnetizing force gives the formula for effective path length.

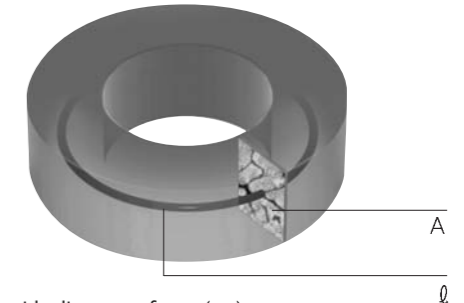

OD = outside diameter of core (cm)
 ID = inside diameter of core (cm)
 A = core cross section (effective area)
 ℓ = mean magnetic path length (cm)

$$\ell = \frac{\pi(OD - ID)}{\ln\left(\frac{OD}{ID}\right)}$$

Q Factor

The Q factor is defined as the ratio of reactance to the effective resistance for an inductor and thus indicates its quality. The Q of wound core can be calculated using the following formula, when neglecting the effects of self-resonance caused by the distributed capacitance resulting from the differential voltage between adjacent turns.

$$Q = \frac{\omega L}{R_{dc} + R_{ac} + R_d}$$

Q = quality factor
 ω = 2π frequency (hertz)
 L = inductance (henries)
 R_{dc} = DC winding resistance (ohms)
 R_{ac} = resistance due to core loss (ohms)
 R_d = resistance due to winding dielectric loss (ohms)

Core Loss

Powder cores have low hysteresis loss, minimizing signal distortion, and low residual loss. The total core loss at low flux densities is the sum of three frequency dependent losses of hysteresis loss, residual loss, and eddy current loss. The core loss is calculated from the following Legg's equation.

$$\frac{R_{ac}}{\omega L} = a B_{\max} f + c f + e f^2$$

| Eddy current loss
 | Residual loss
 | Hysteresis loss
 | Total loss factor

Where R_{ac} = core loss resistance (ohms)
 a = hysteresis loss coefficient
 c = residual loss coefficient
 e = eddy current loss coefficient
 ω L, B_{max}, f = same as mentioned before

When a varying magnetic field passes through the core, eddy currents are induced in it. Joule heat loss by these currents is called eddy current loss. Hysteresis loss is due to the irreversible behavior in the hysteresis curve and equal to the enclosed area of the loop. The other core loss is called residual loss.

■ Permeability vs DC Bias Curves

MPP

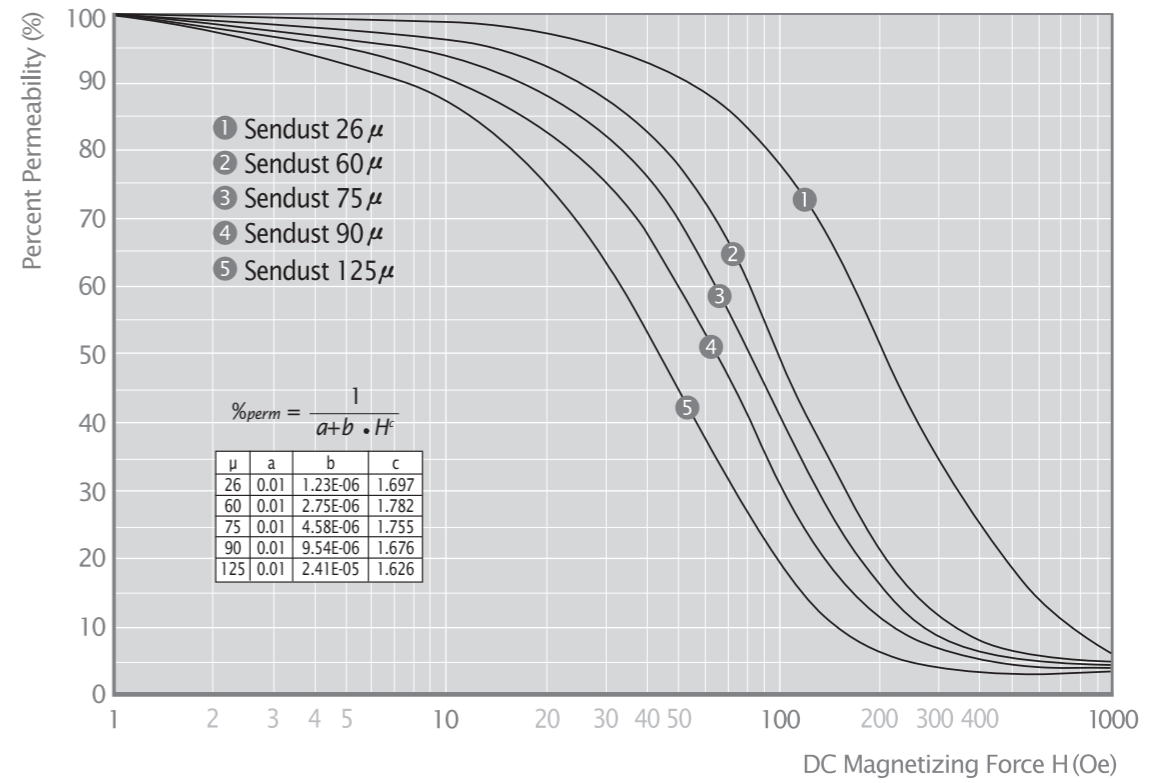
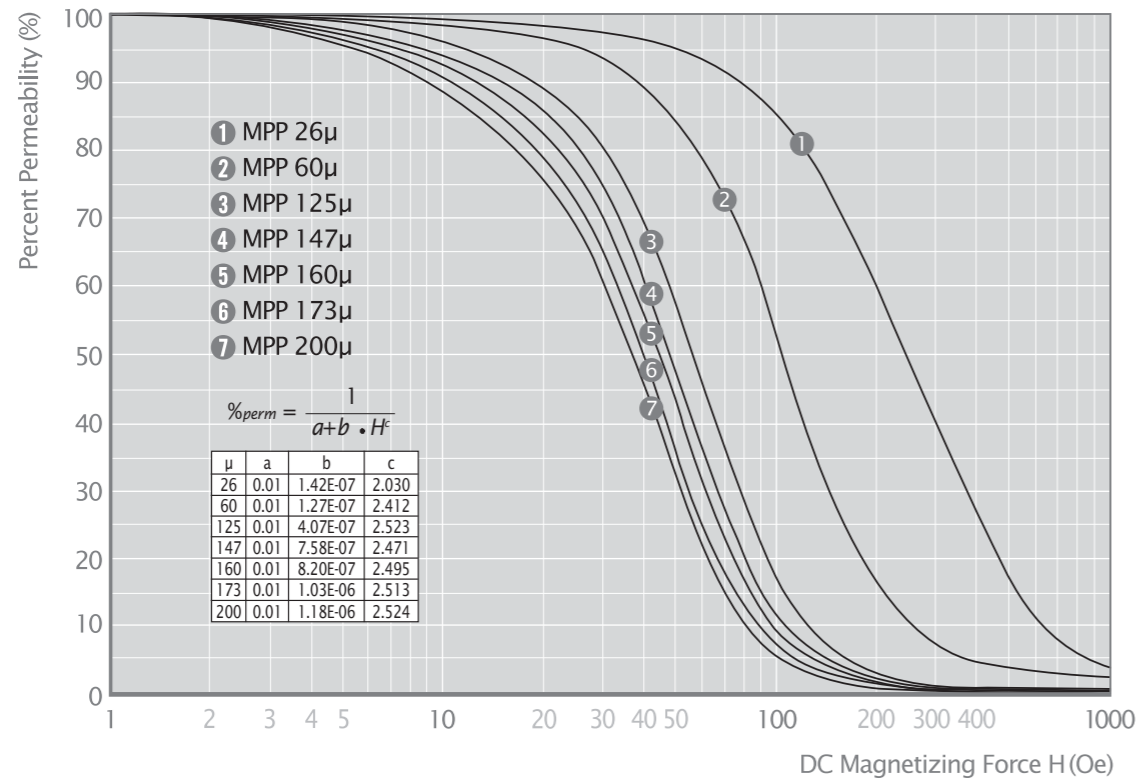

Sendust

High Flux

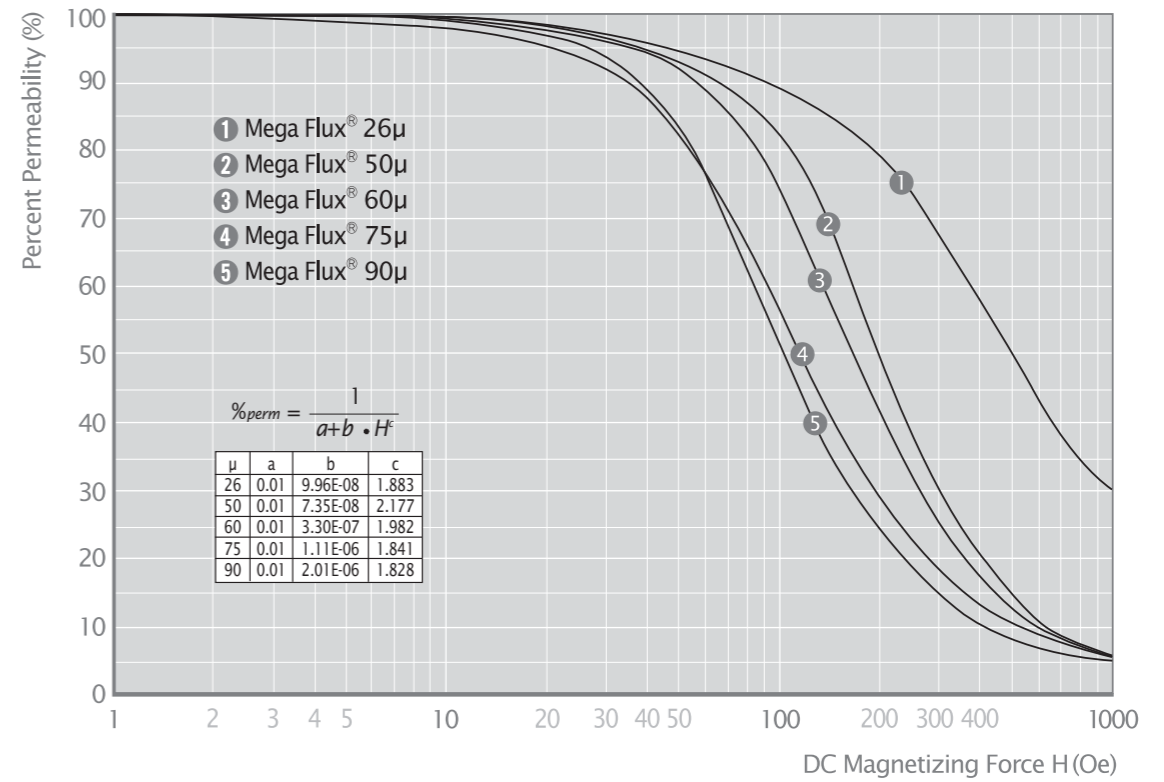
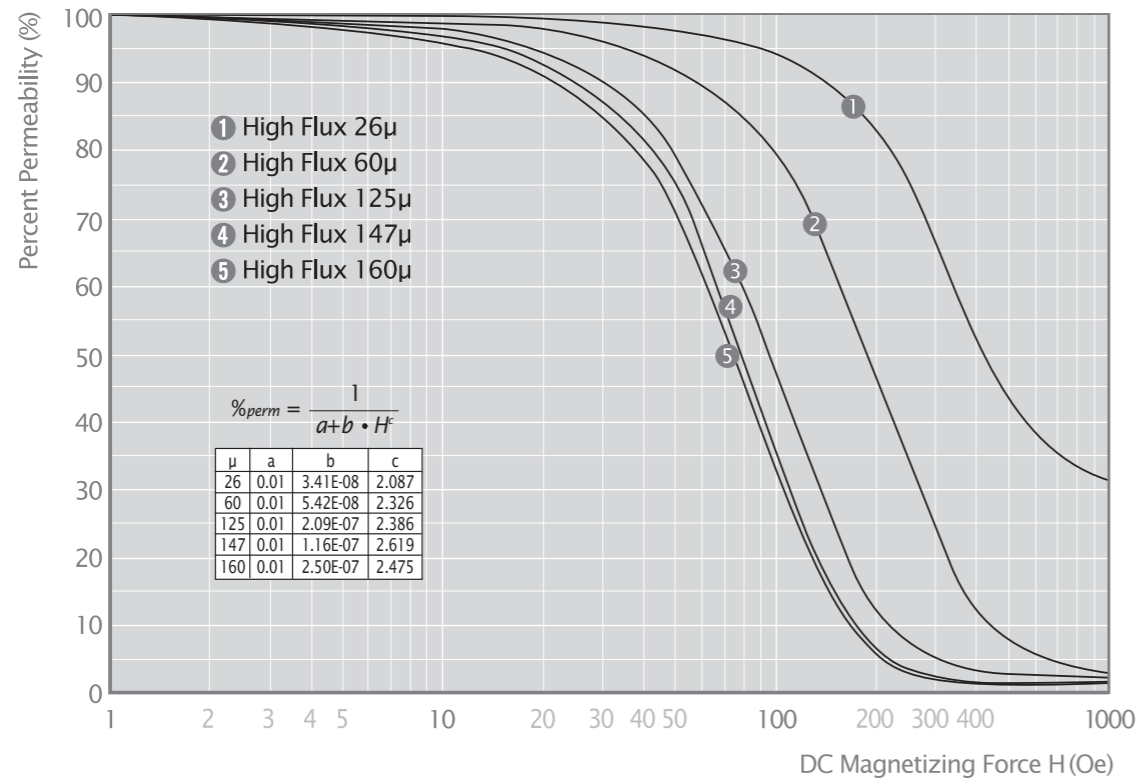

Mega Flux®

■ Permeability vs Frequency Curves

MPP

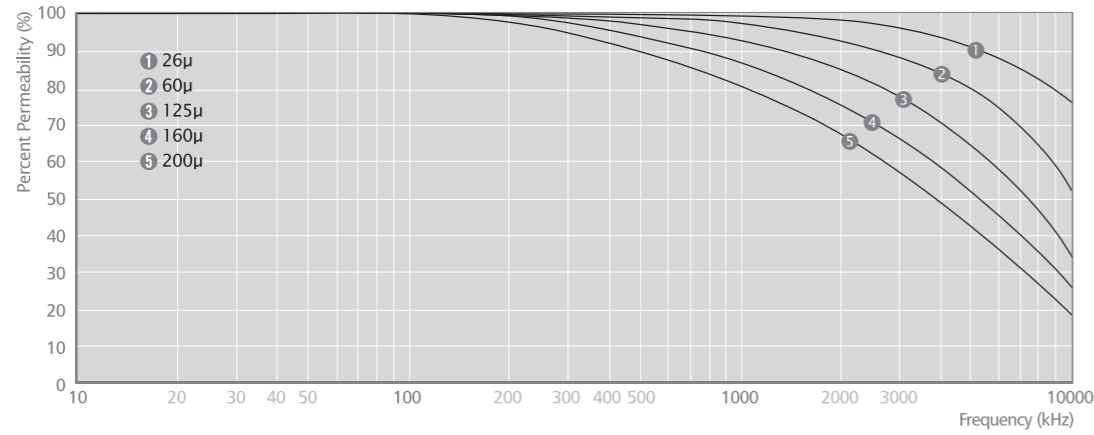

High Flux

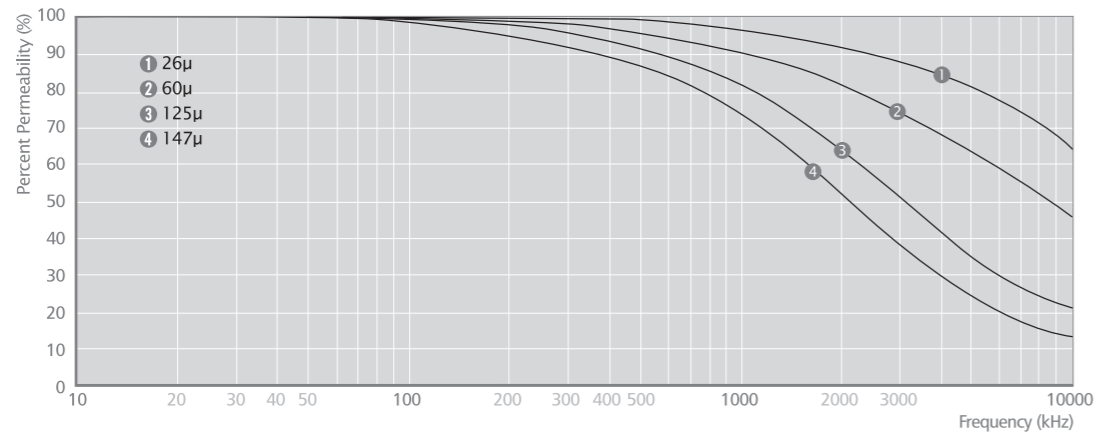

Sendust

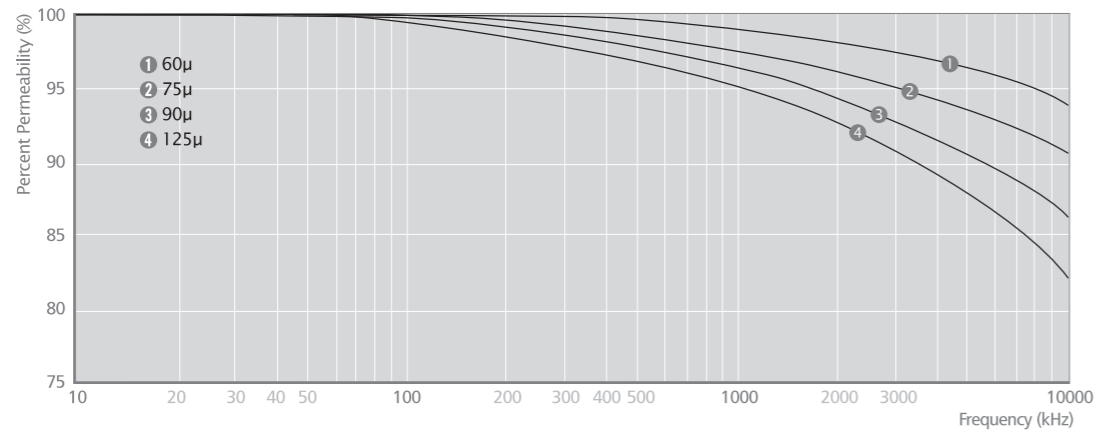

Mega Flux®

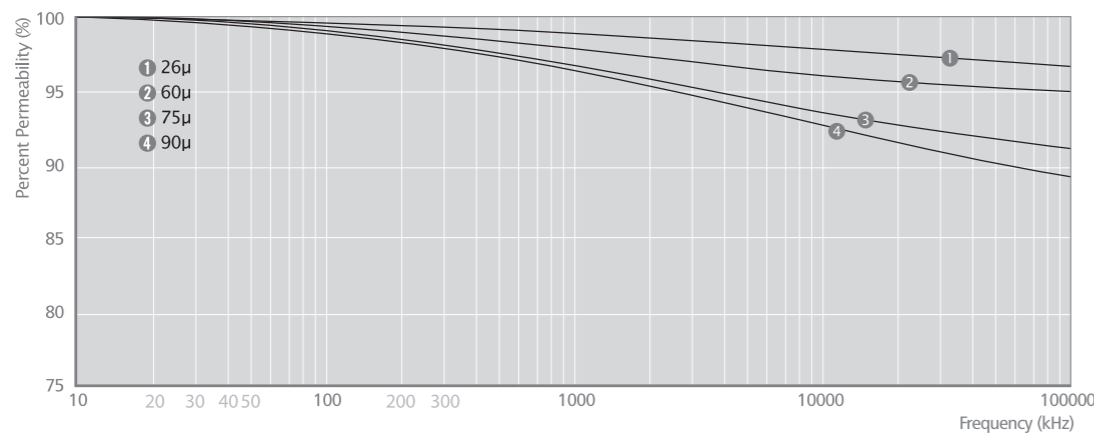

■ MPP Core Loss

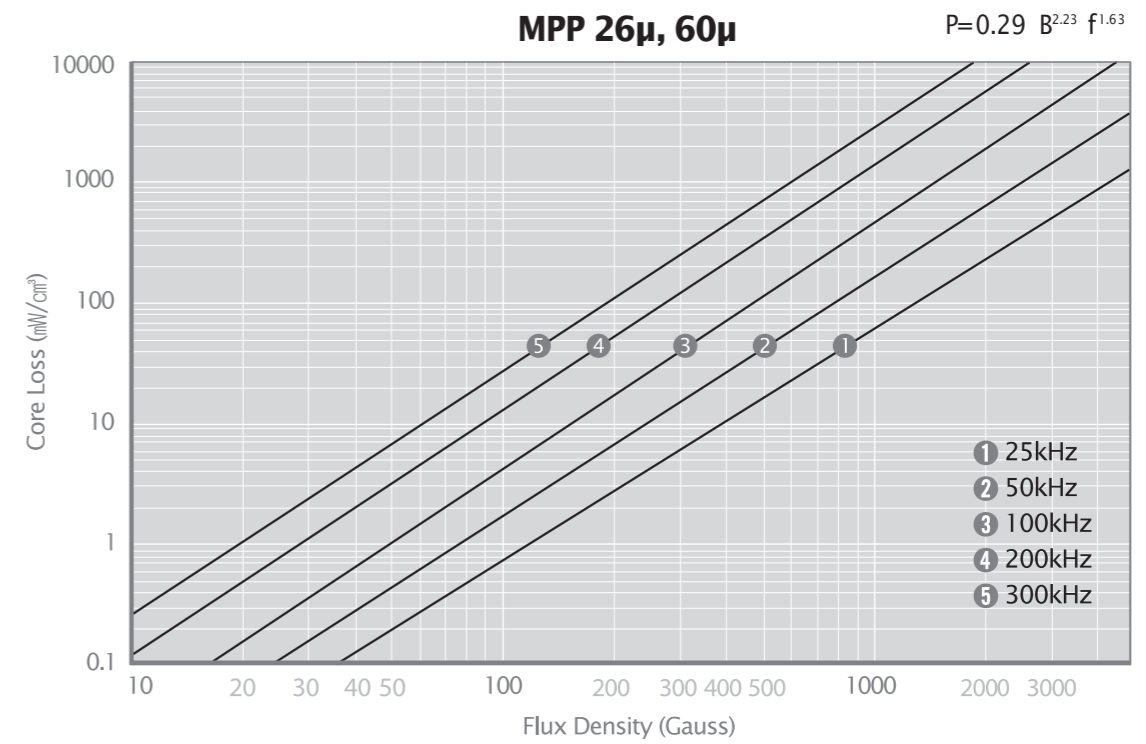

MPP 26μ, 60μ

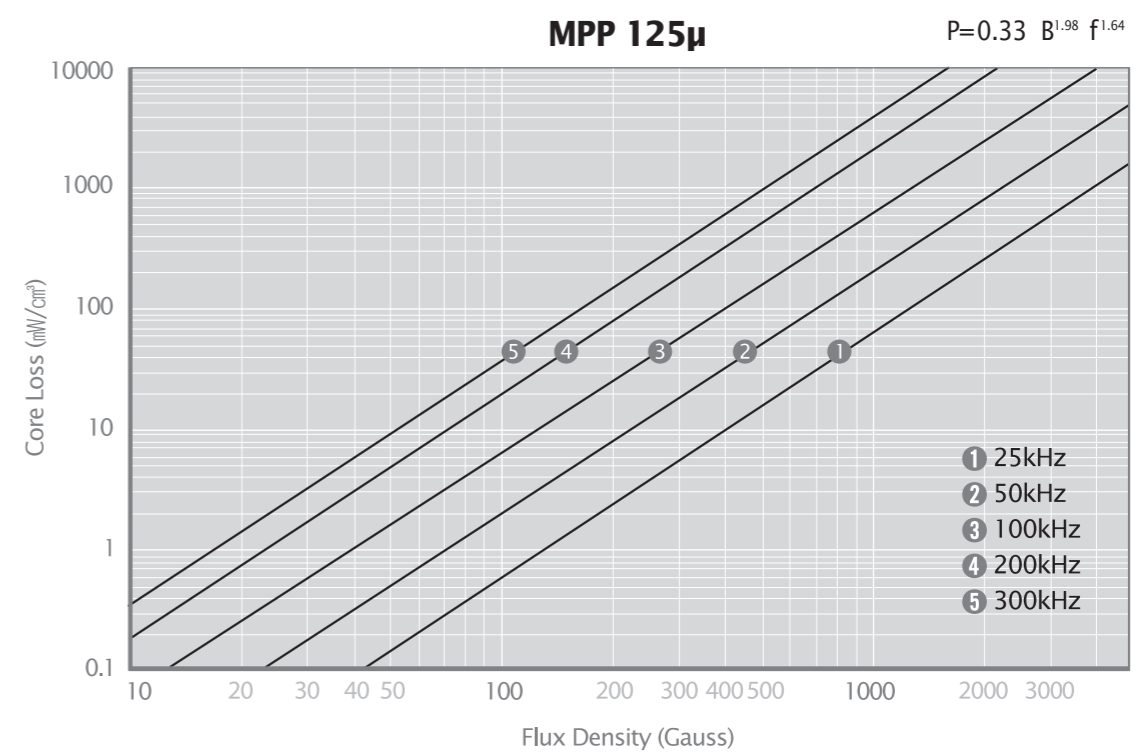

MPP 125μ

■ MPP Core Loss

MPP 147μ, 160μ, 173μ

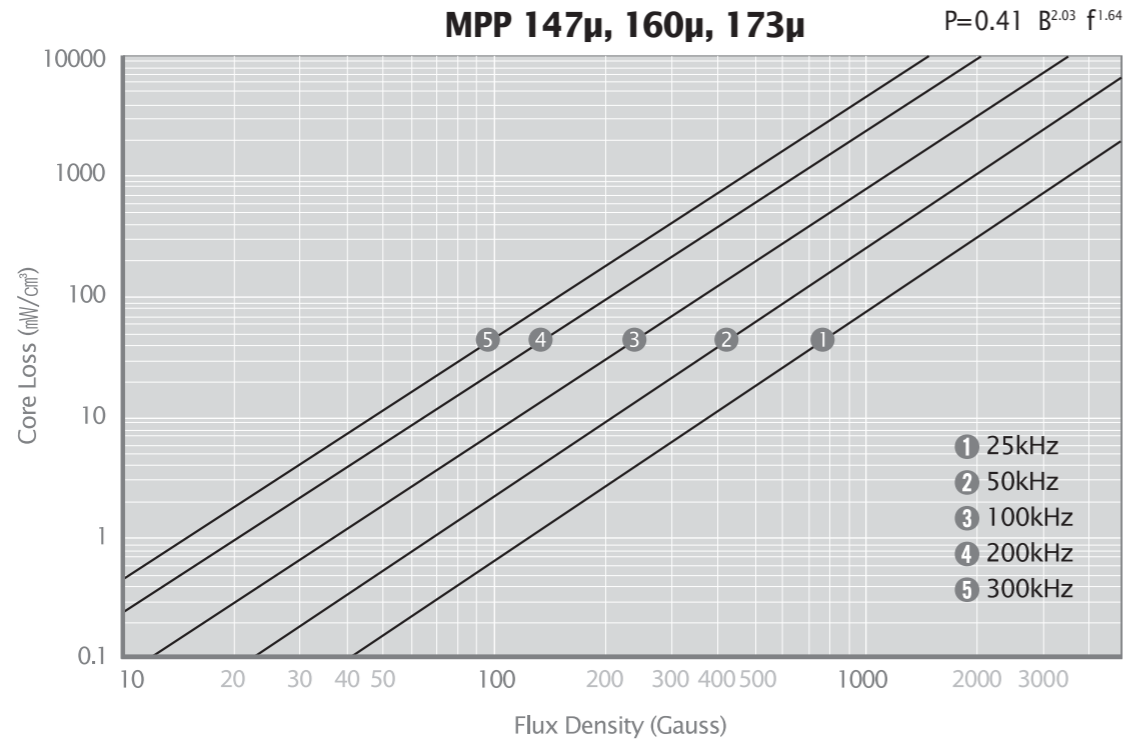

■ High Flux Core Loss

High Flux 26μ

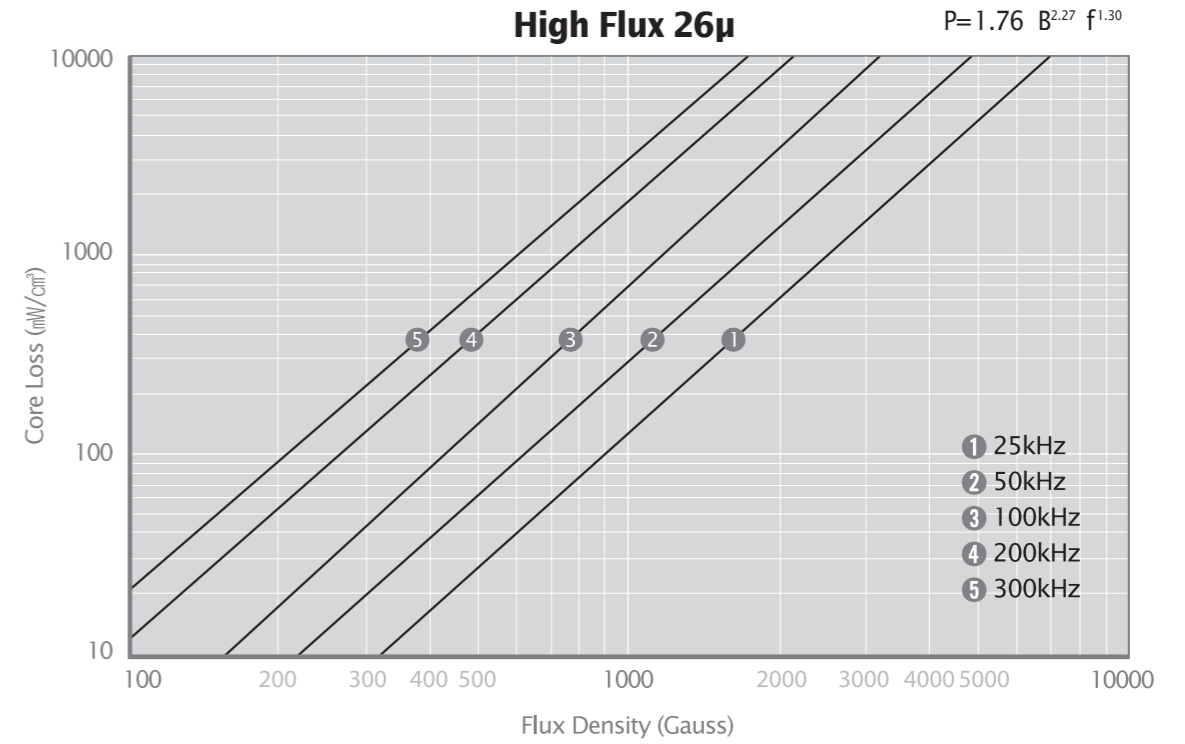

MPP 200μ

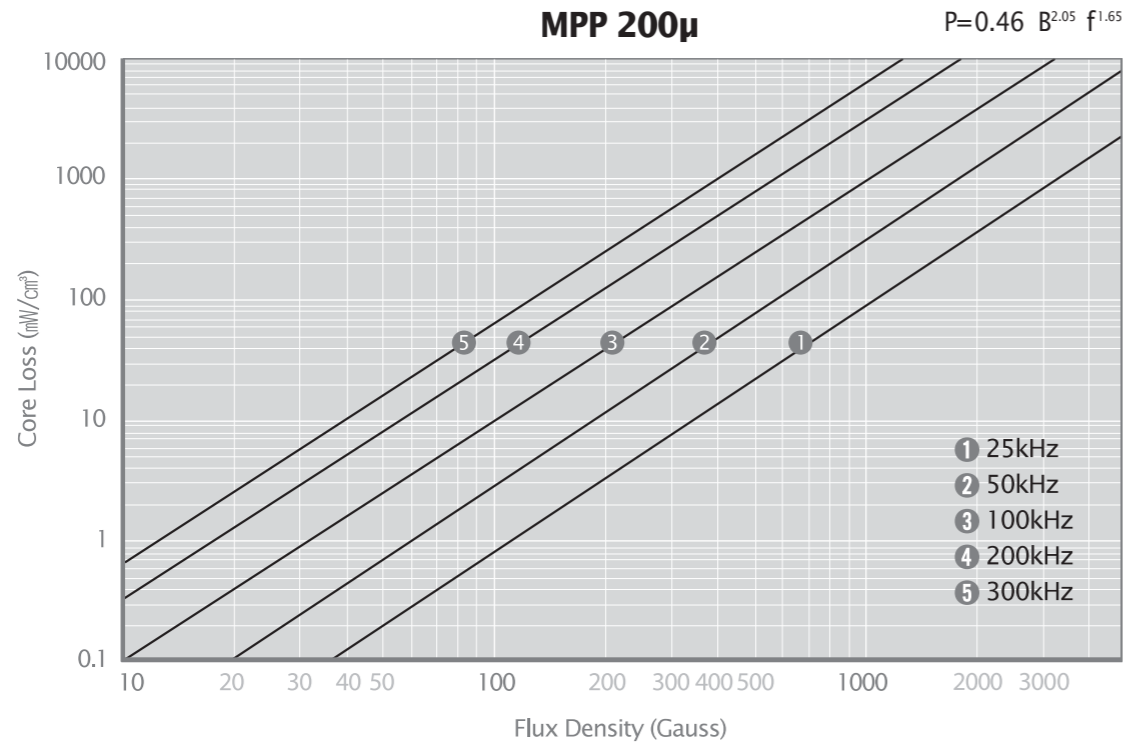

High Flux 60μ

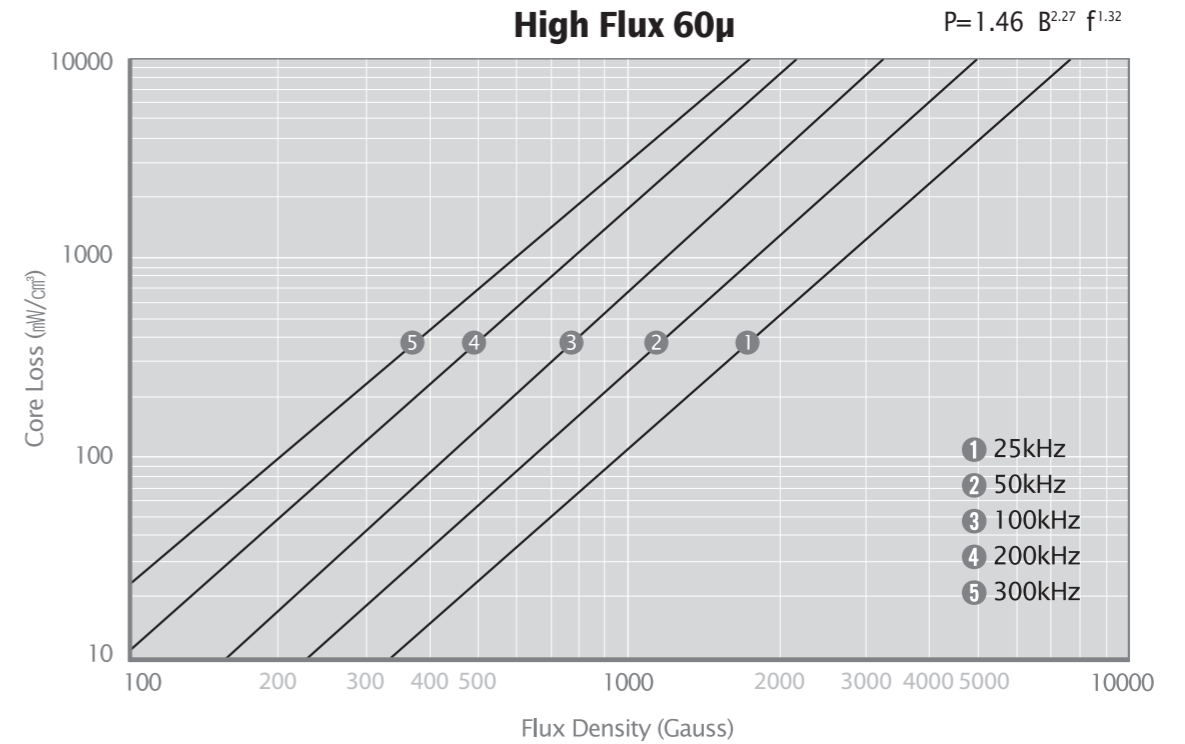

■ High Flux Core Loss

High Flux 125μ

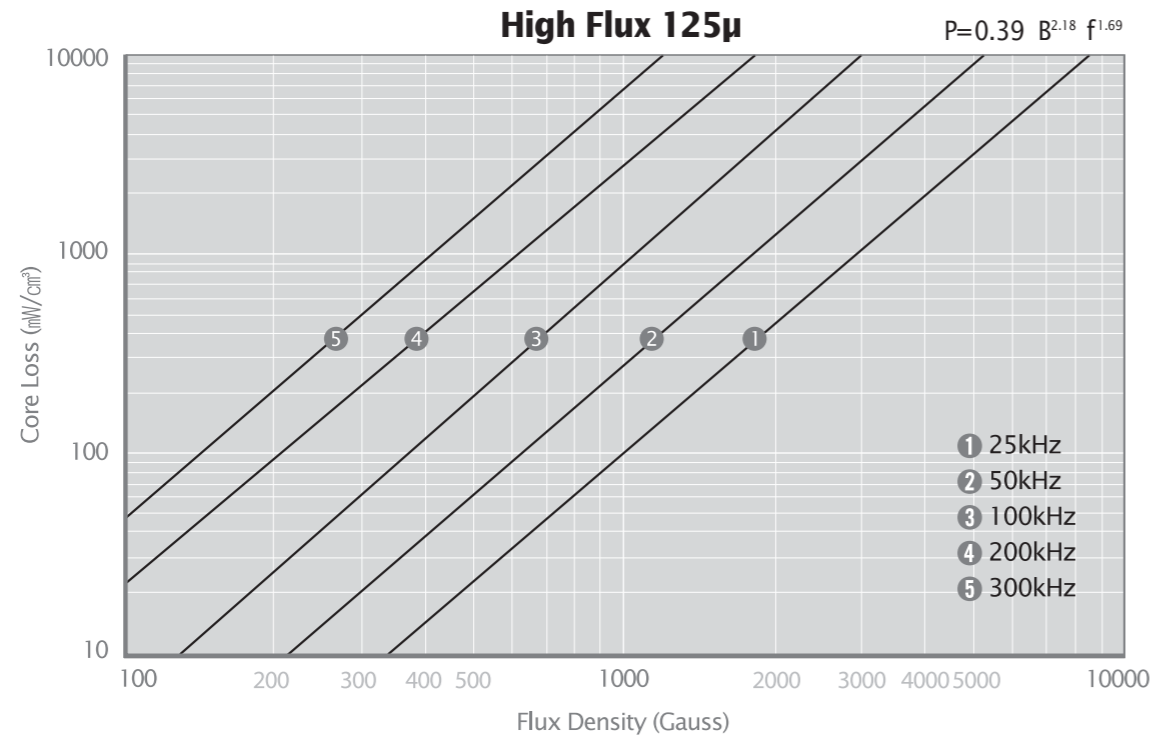

■ Sendust Core Loss

Sendust 26μ

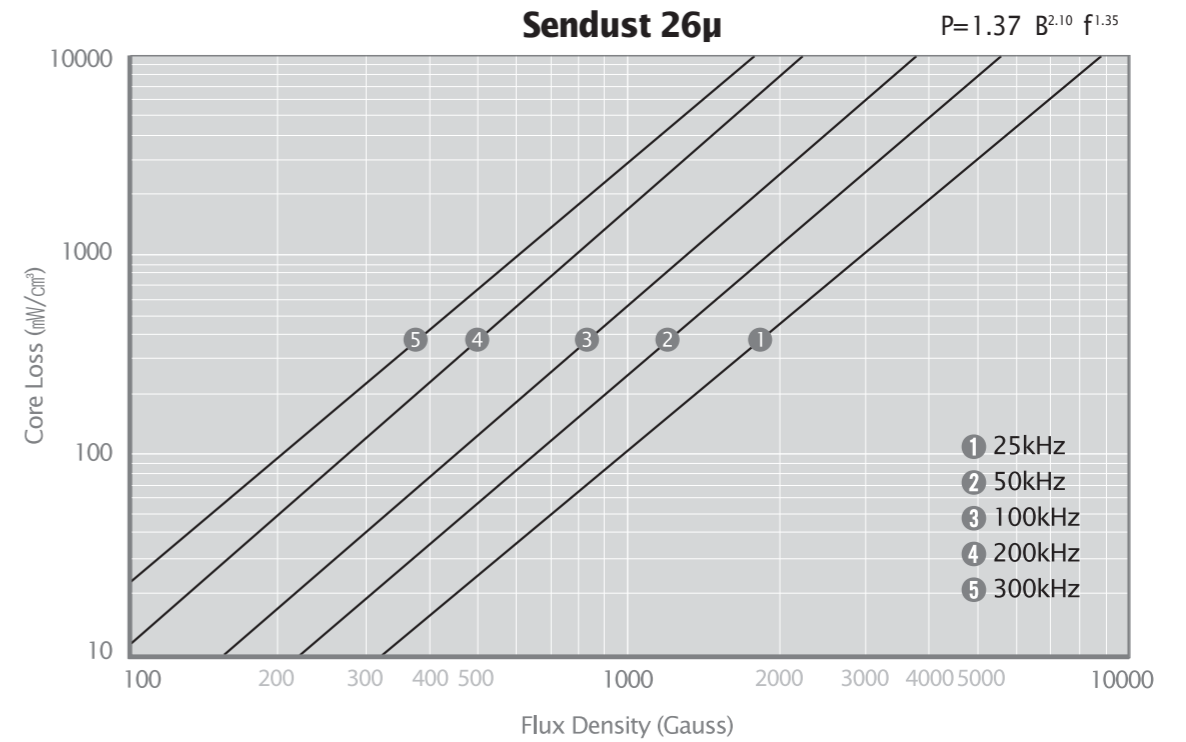

High Flux 147μ, 160μ

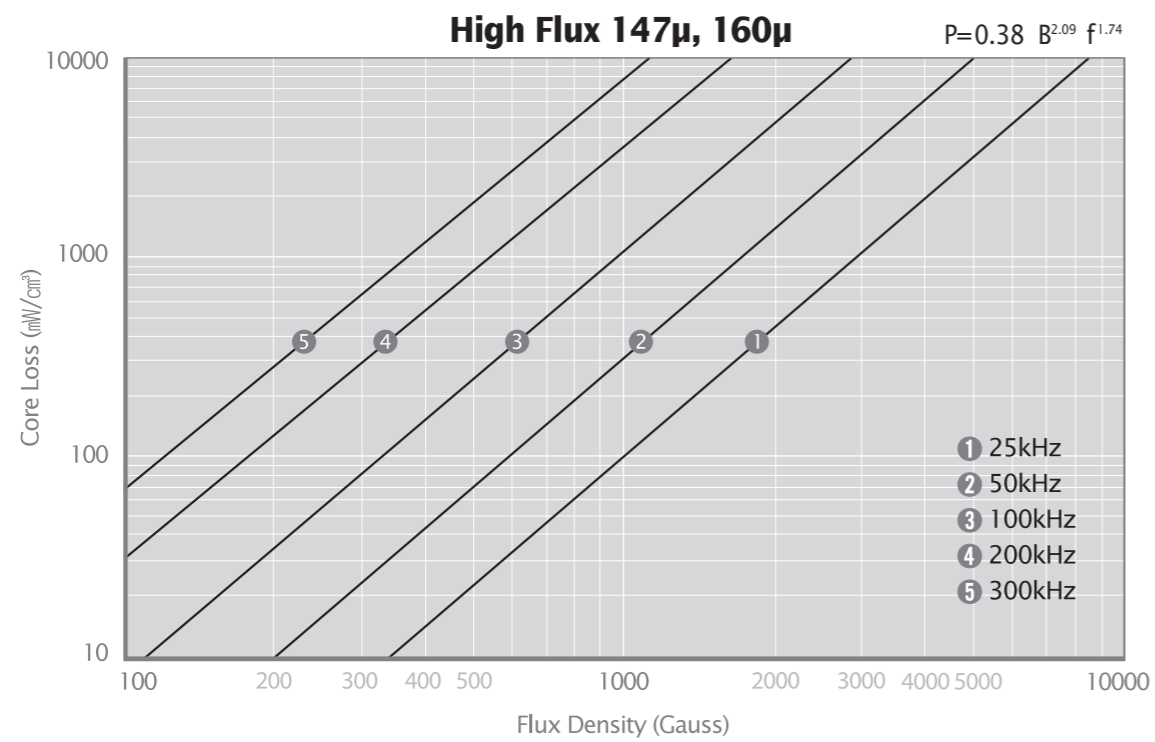

Sendust 60μ, 75μ, 90μ, 125μ

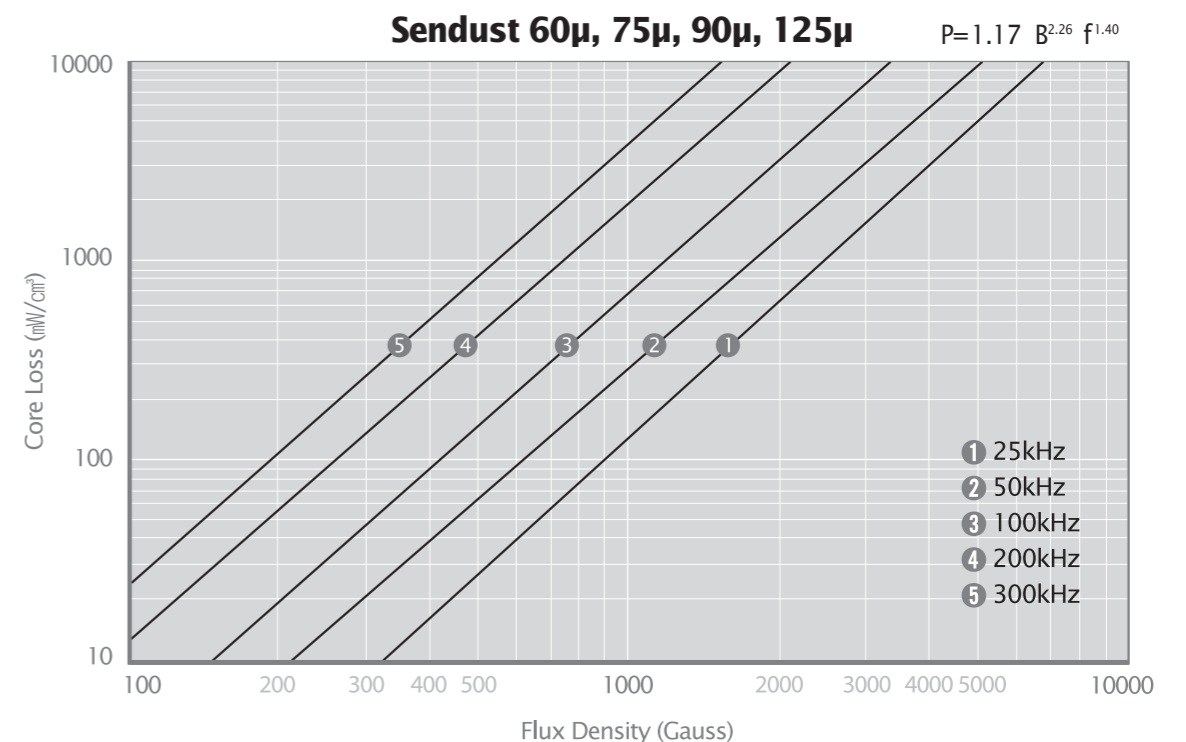

■ Mega Flux® Core Loss

Mega Flux® 26μ

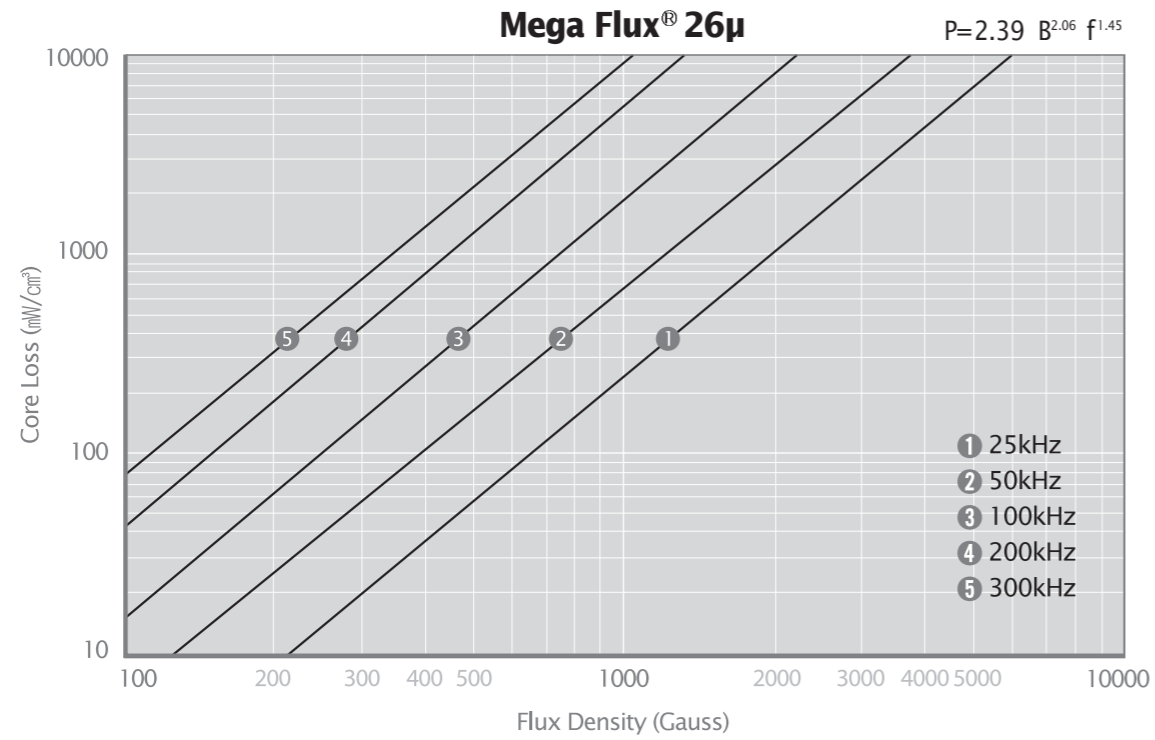

Mega Flux® 50μ, 60μ, 75μ, 90μ

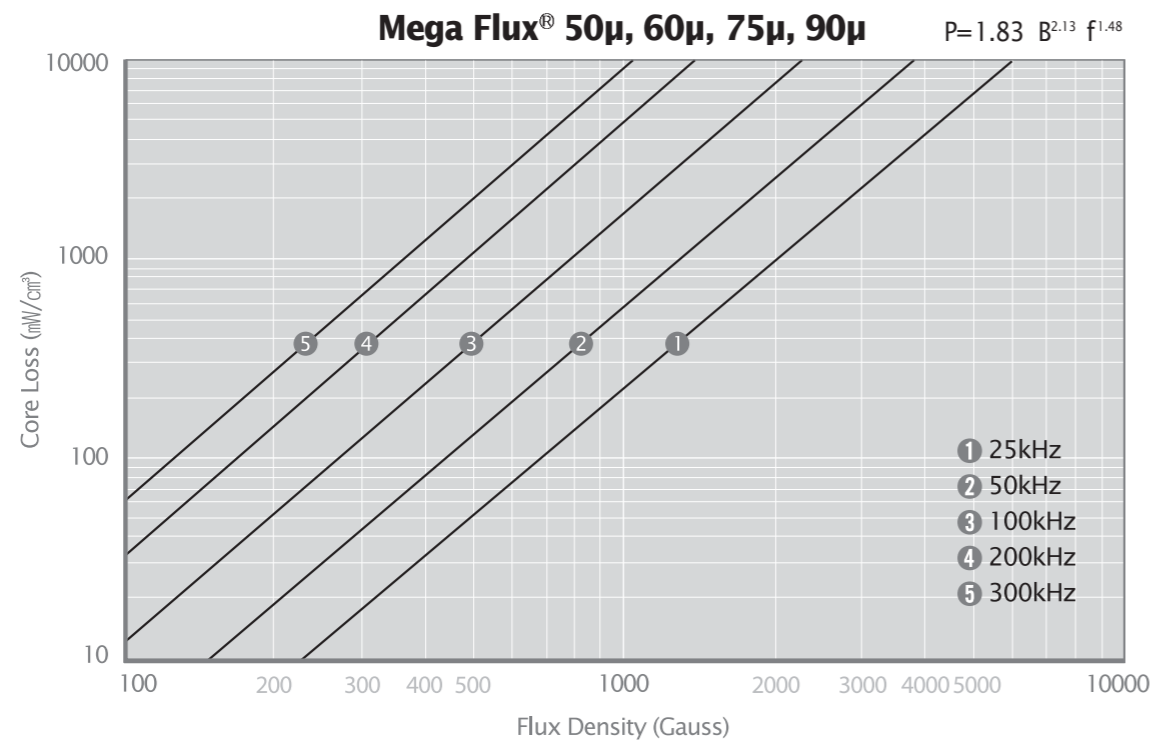

■ Temperature Stability

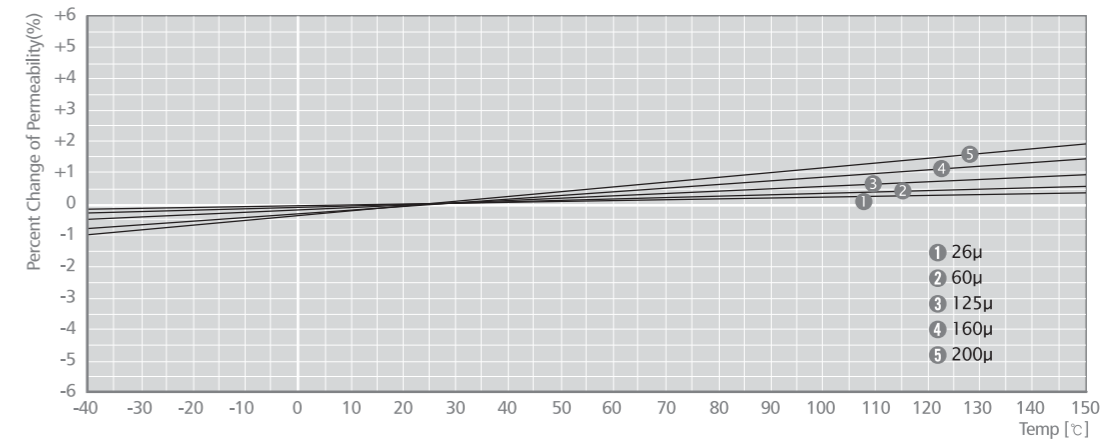

MPP

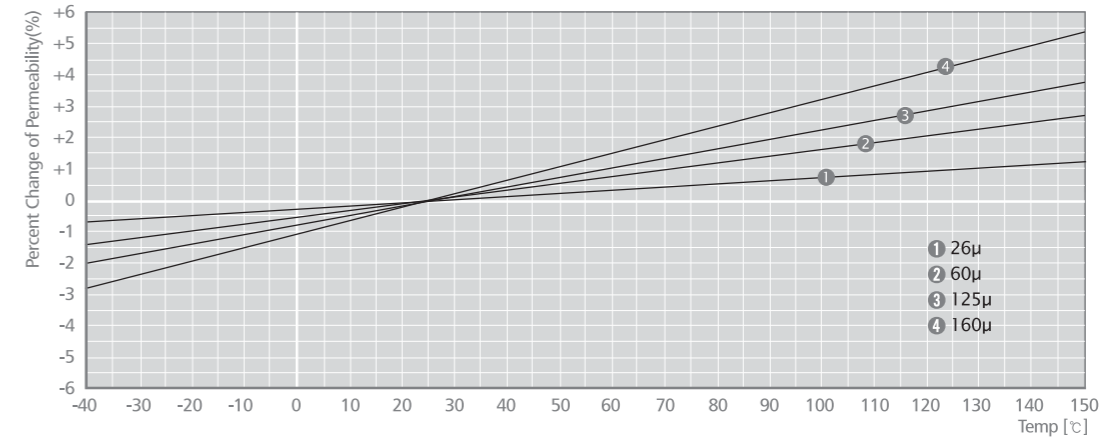

High Flux

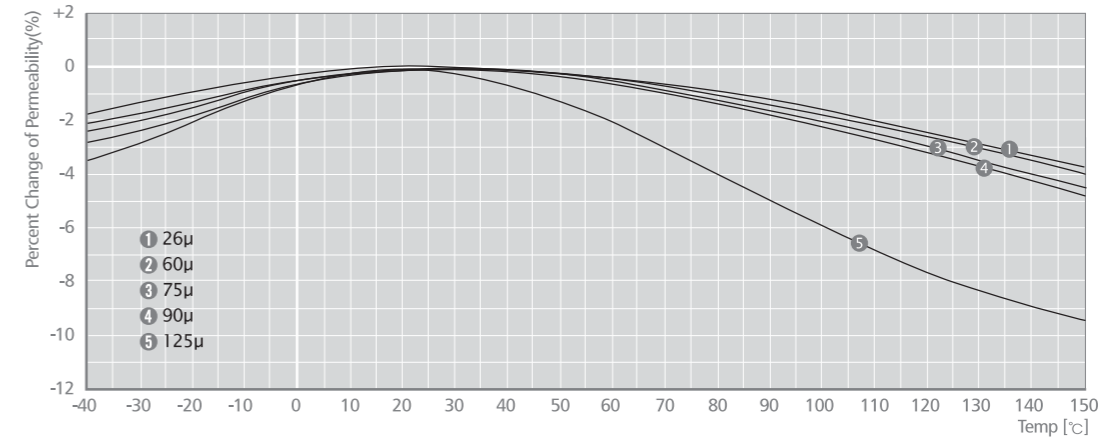

Sendust

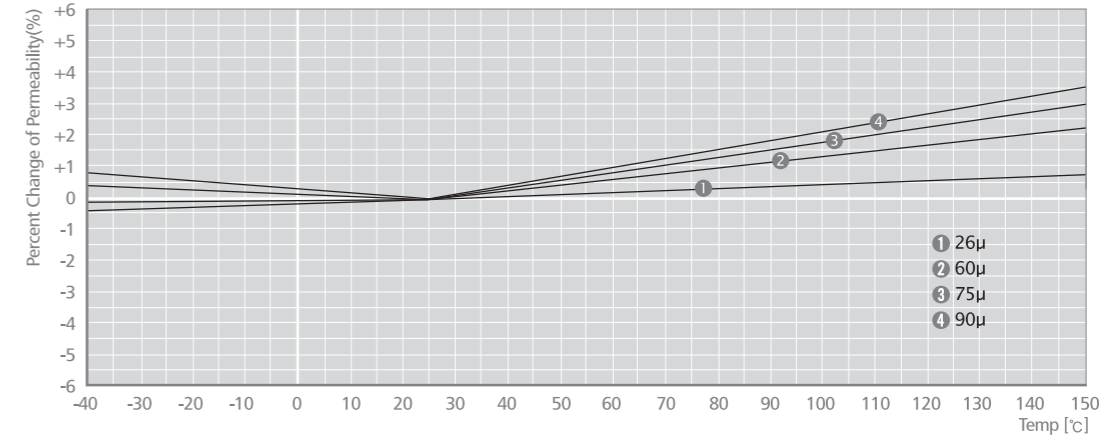

Mega Flux®



TOROIDAL MAGNETIC POWDER CORES

Tolerance of A_L value

Core Size	Sendust	MPP	High Flux	Maga Flux®
OD 035~OD 046	±15%	±12%	±12%	NA
OD 063~OD 112	±12%	±8%	±8%	±8%
OD 127~OD 1625	±8%	±8%	±8%	±8%

Inductance Calculation by A_L vs NI Curves;

Inductor specification

- Core : CM270125
- Number of Winding : 22Turns
- Current : DC 10Amperes

Solution

- Calculate NI (Ampere · Turns) NI = 22Turns X 10Ampere = 220
- Read the A_L value of CM270125 using the A_L vs NI curve on page 43.
 A_L value of CM270125 yields 100.4 when NI is 220.
- Calculate L at 10Ampere by using formula; $LN = A_L \times N^2 \times 10^{-3}(\mu H)$
Therefore,

$$L(@10A) = 100.4 \times 22^2 \times 0.001 = 48.6(\mu H)$$

※ Inductance calculation by Permeability vs DC Bias Curve is also available on Page 11.

OD035

OD 3.56mm / 0.140inch



ID 1.78mm
HT 1.52mm

Core Dimensions

		OD(max)	ID(min)	HT(max)
Before coating	(mm)	3.56	1.78	1.52
	(inch)	0.140	0.070	0.060
After coating (Parylene-C)	(mm)	3.76	1.58	1.72
	(inch)	0.148	0.062	0.068

Magnetic Dimensions

Cross Section (A)	Path Length (l)	Window Area (Wa)	Volume (V)
0.0137cm ²	0.817cm	0.018cm ²	0.010746cm ³
0.002in ²	0.317in	3,600cmil	0.000656in ³

Available Cores

MPP	Part No.			AL (nH/N ²)	Perm. (μ)
	High Flux	Sendust	Mega Flux [®]		
-	-	-	-	-	26
CM035060	CH035060	CS035060	CK035060	13	60
-	-	CS035075	CK035075	16	75
-	-	CS035090	CK035090	19	90
CM035125	CH035125	CS035125	-	26	125
CM035147	-	-	-	31	147
CM035160	-	-	-	33	160
-	-	-	-	-	173
-	-	-	-	-	200

Winding Information

AWG Wire No.	Single Layer Dia(cm)	Turn	Rdc, Ω	AWG Wire No.	Single Layer Dia(cm)	Turn	Rdc, Ω
28	0.0366	9	0.0237	37	0.0140	27	0.363
29	0.0330	10	0.0314	38	0.0124	30	0.503
30	0.0294	11	0.0431	39	0.0199	35	0.727
31	0.0267	13	0.0581	40	0.0096	40	1.02
32	0.0241	14	0.0768	41	0.00863	44	1.37
33	0.0216	16	0.105	42	0.00762	50	1.90
34	0.0191	19	0.146	43	0.00685	56	2.67
35	0.0170	21	0.200	44	0.00635	60	3.45
36	0.0152	24	0.272				

Single layer winding with 1 inch leads

AL vs NI Curve (125μ)

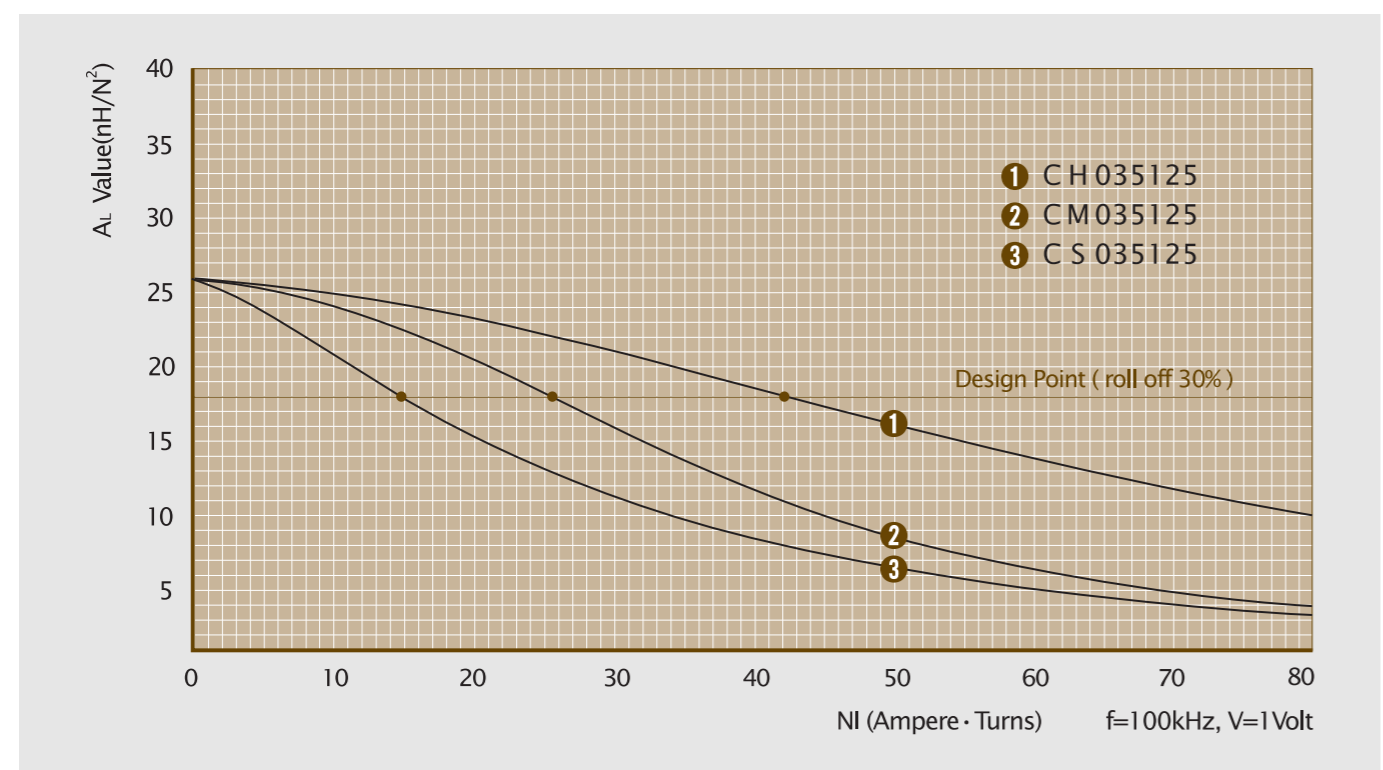

OD039

OD 3.94mm / 0.155inch

ID 2.24mm
HT 2.54mm



Core Dimensions

		OD(max)	ID(min)	HT(max)
Before coating	(mm)	3.94	2.24	2.54
	(inch)	0.155	0.088	0.100
After coating (Parylene-C)	(mm)	4.14	2.04	2.74
	(inch)	0.163	0.080	0.108

Magnetic Dimensions

Cross Section (A)	Path Length (l)	Window Area (Wa)	Volume (V)
0.0211cm ²	0.942cm	0.0308cm ²	0.019670cm ³
0.003245in ²	0.370inch	6,080cmil	0.001200in ³

Winding Information

AWG Wire No.	Single Layer Dia(cm)	Turn	Rdc, Ω	AWG Wire No.	Single Layer Dia(cm)	Turn	Rdc, Ω
27	0.0409	11	0.0248	36	0.0152	33	0.430
28	0.0366	12	0.0342	37	0.0140	36	0.579
29	0.0330	14	0.0458	38	0.0124	41	0.807
30	0.0294	16	0.0638	39	0.0109	47	1.18
31	0.0267	18	0.0869	40	0.0096	53	1.67
32	0.0241	20	0.116	41	0.00863	59	2.25
33	0.0216	23	0.161	42	0.00762	67	3.15
34	0.0191	26	0.226	43	0.00685	74	4.45
35	0.0170	29	0.313	44	0.00635	80	5.76

Single layer winding with 1 inch leads

Available Cores

MPP	Part No.			AL (nH/N ²)	Perm. (μ)
	High Flux	Sendust	Mega Flux [®]		
-	-	-	-	-	26
CM039060	CH039060	CS039060	CK039060	17	60
-	-	CS039075	CK039075	21	75
-	-	CS039090	CK039090	25	90
CM039125	CH039125	CS039125	-	35	125
CM039147	-	-	-	41	147
CM039160	-	-	-	45	160
-	-	-	-	-	173
-	-	-	-	-	200

AL vs NI Curve (125μ)

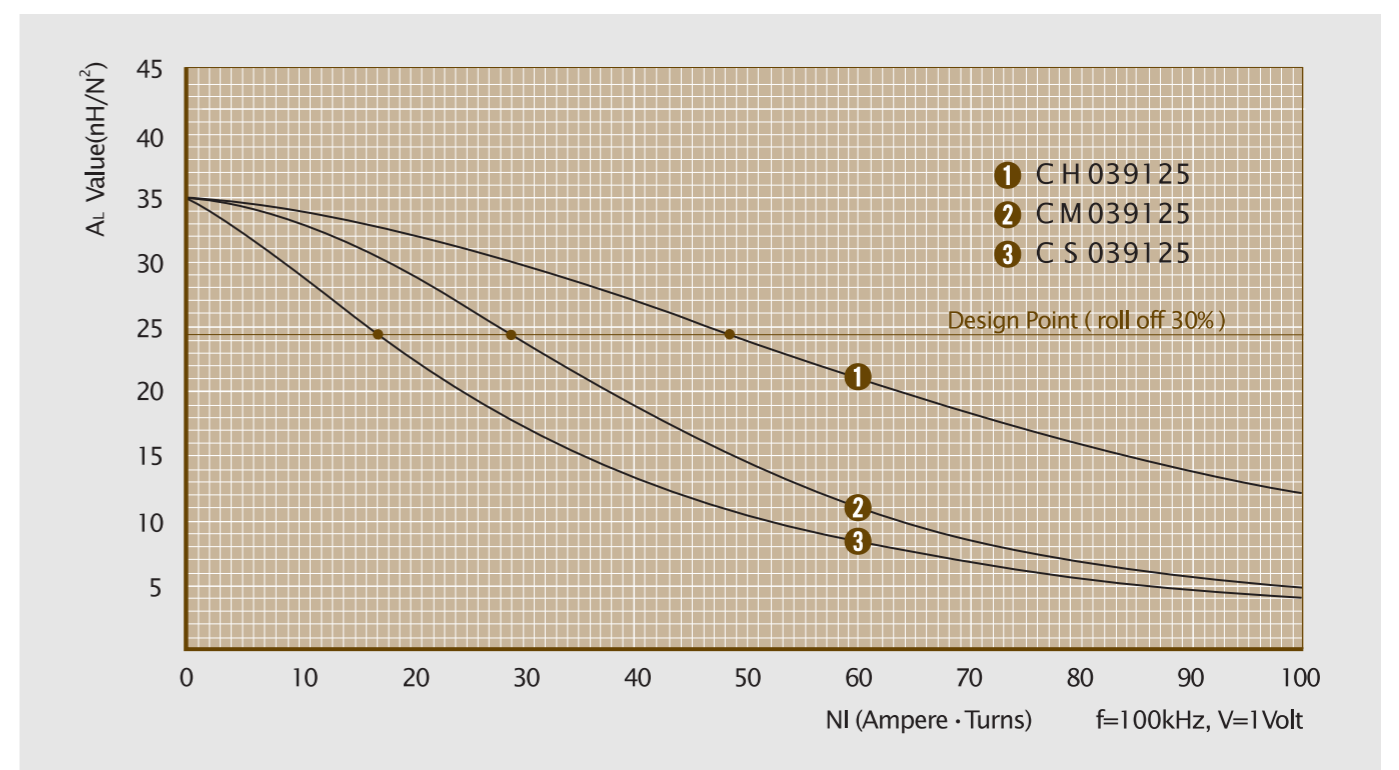

OD046

OD 4.65mm / 0.183inch

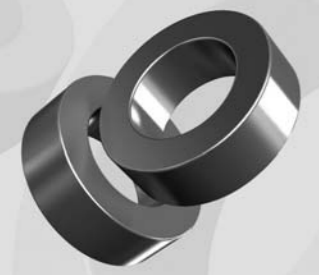

ID 2.36mm
HT 2.54mm

Core Dimensions

		OD(max)	ID(min)	HT(max)
Before coating	(mm)	4.65	2.36	2.54
	(inch)	0.183	0.093	0.100
After coating (parlylene-C)	(mm)	4.85	2.16	2.74
	(inch)	0.191	0.085	0.108

Magnetic Dimensions

Cross Section (A)	Path Length (l)	Window Area (Wa)	Volume (V)
0.0285cm ²	1.060cm	0.029cm ²	0.0302cm ³
0.00442in ²	0.418in	5,780cmil	0.001837in ³

Available Cores

MPP	Part No.			AL	Perm.
	High Flux	Sendust	Mega Flux®		
-	-	-	-	-	26
CM046060	CH046060	CS046060	CK046060	20	60
-	-	CS046075	CK046075	25	75
-	-	CS046090	CK046090	30	90
CM046125	CH046125	CS046125	-	42	125
CM046147	-	-	-	49	147
CM046160	-	-	-	53	160
-	-	-	-	-	173
-	-	-	-	-	200

Winding Information

AWG Wire No.	Single Layer		AWG Wire No.	Single Layer	
	Turn	Rdc, Ω		Turn	Rdc, Ω
26	0.0452	9	0.0205	35	0.0170
27	0.0409	10	0.0280	36	0.0152
28	0.0366	12	0.0388	37	0.0140
29	0.0330	13	0.0524	38	0.0124
30	0.0294	15	0.0734	39	0.0109
31	0.0267	17	0.101	40	0.0096
32	0.0241	19	0.135	41	0.00863
33	0.0216	22	0.188	42	0.00762
34	0.0191	25	0.266	43	0.00685

Single layer winding with 1 inch leads

AL vs NI Curve (60μ, 125μ)

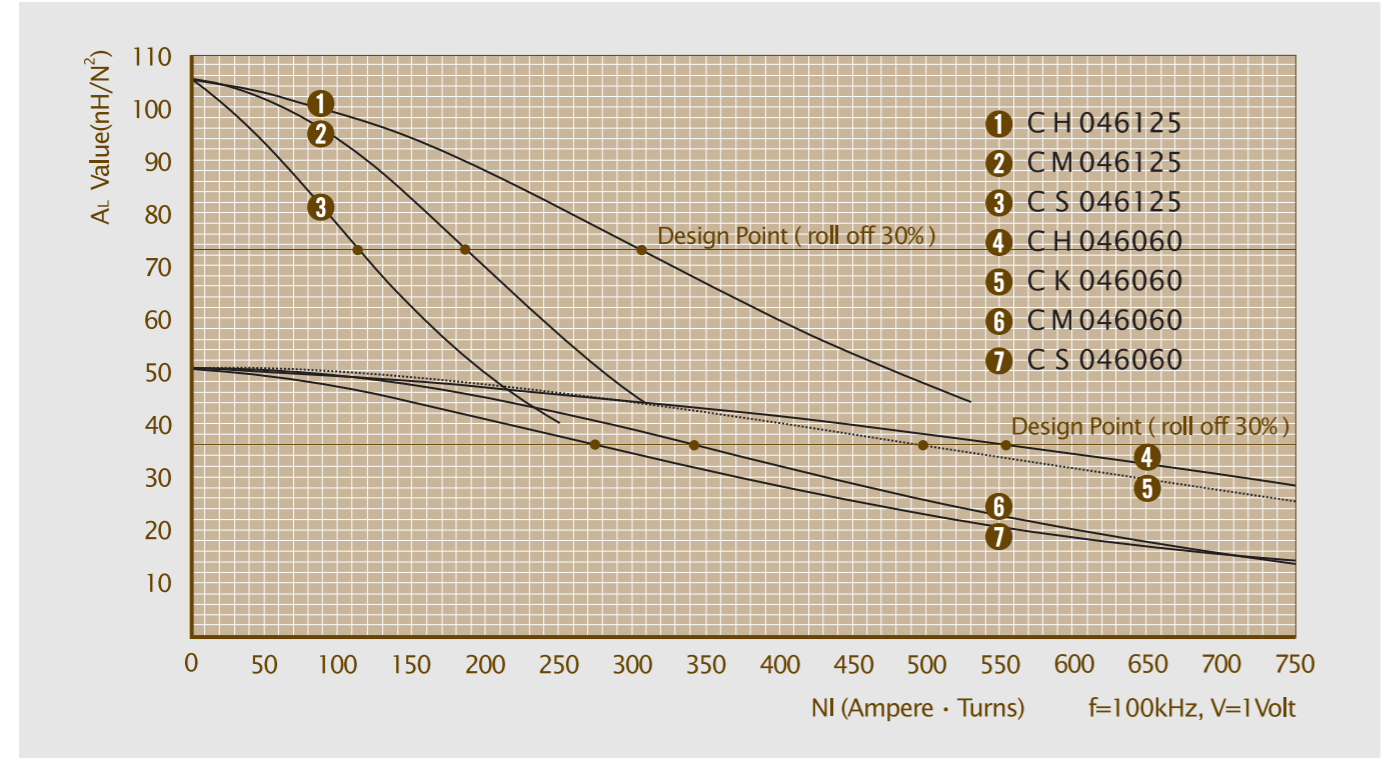

OD063

OD 6.35mm / 0.250inch

ID 2.79mm
HT 2.79mm



Core Dimensions

		OD(max)	ID(min)	HT(max)
Before coating	(mm)	6.35	2.79	2.79
	(inch)	0.250	0.110	0.110
After coating (parlylene-C)	(mm)	6.99	2.29	3.43
	(inch)	0.275	0.090	0.135

Magnetic Dimensions

Cross Section (A)	Path Length (l)	Window Area (Wa)	Volume (V)
0.0470cm ²	1.361cm	0.0412cm ²	0.064219cm ³
0.00729in ²	0.536in	8,100cmil	0.003919in ³

Winding Information

AWG Wire No.	Single Layer		AWG Wire No.	Single Layer	
	Turn	Rdc, Ω		Turn	Rdc, Ω
24	0.0566	8	0.0132	33	0.0216
25	0.0505	10	0.0183	34	0.0191
26	0.0452	11	0.0253	35	0.0170
27	0.0409	13	0.0346	36	0.0152
28	0.0366	14	0.0482	37	0.0140
29	0.0330	16	0.0653	38	0.0124
30	0.0294	19	0.0918	39	0.0109
31	0.0267	21	0.126	40	0.0096
32	0.0241	23	0.170	41	0.00863

Single layer winding with 1 inch leads

Available Cores

MPP	Part No.			AL	Perm.
	High Flux	Sendust	Mega Flux®		
-	-	-	-	-	26
CM063060	CH063060	CS063060	CK063060	24	60
-	-	CS063075	CK063075	30	75
-	-	CS063090	CK063090	36	90
CM063125	CH063125	CS063125	-	50	125
CM063147	CH063147	-	-	59	147
CM063160	CH063160	-	-	64	160
CM063173	-	-	-	69	173
CM063200	-	-	-	80	200

AL vs NI Curve (60μ, 125μ)

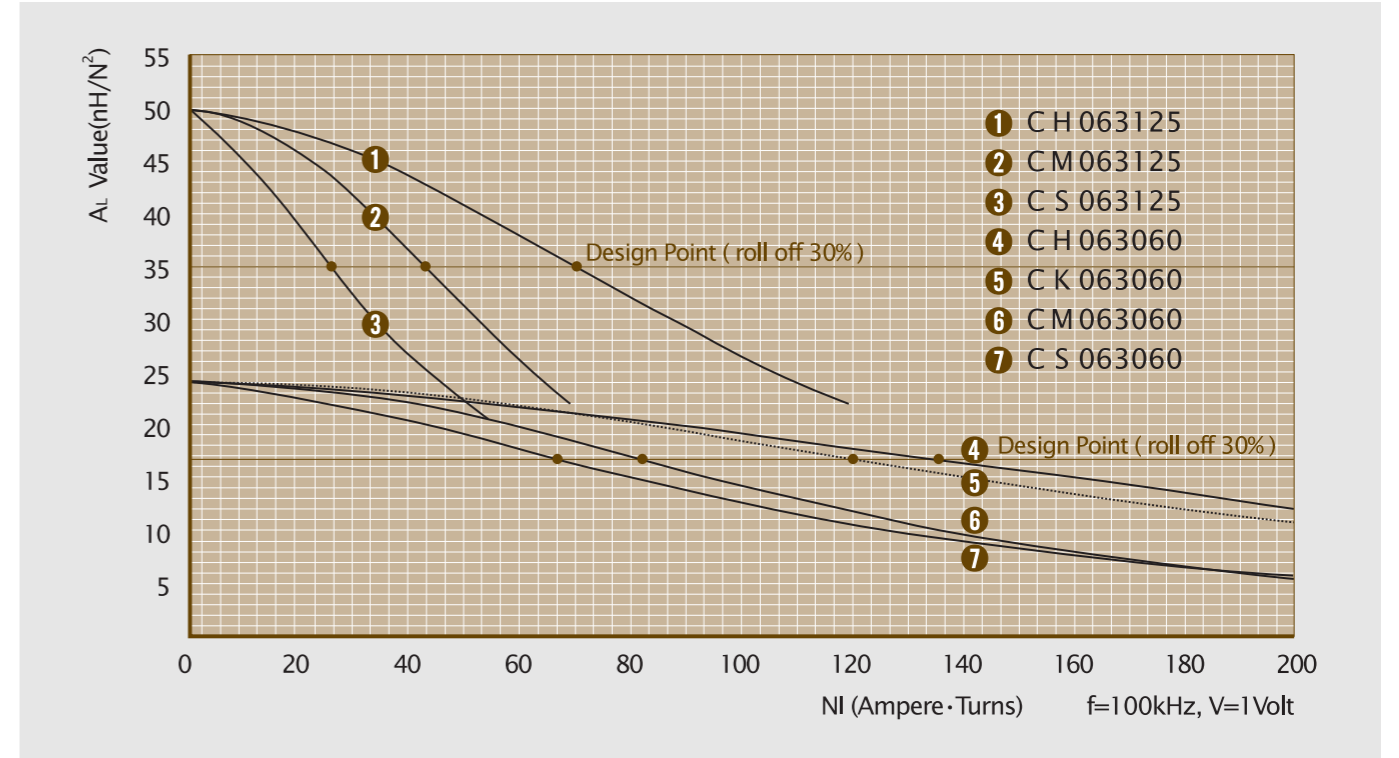

OD066

OD 6.6mm / 0.260inch

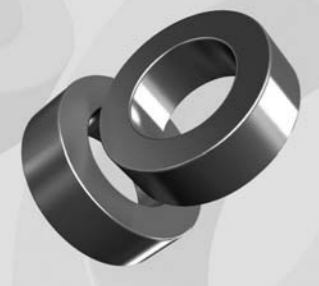

ID 2.67mm
HT 2.54mm

Core Dimensions

		OD(max)	ID(min)	HT(max)
Before coating	(mm)	6.6	2.67	2.54
	(inch)	0.260	0.105	0.100
After coating (Epoxy)	(mm)	7.24	2.29	3.18
	(inch)	0.285	0.090	0.125

Magnetic Dimensions

Cross Section (A)	Path Length (l)	Window Area (Wa)	Volume (V)
0.0476cm ²	1.363cm	0.0412cm ²	0.063971cm ³
0.00738in ²	0.537in	8,100cmil	0.003904in ³

Available Cores

Part No.				A _L	Perm.
MPP	High Flux	Sendust	Mega Flux [®]	(nH/N ²)	(μ)
CM066026	CH066026	-	-	11	26
CM066060	CH066060	CS066060	CK066060	26	60
-	-	CS066075	CK066075	32	75
-	-	CS066090	CK066090	39	90
CM066125	CH066125	CS066125	-	54	125
CM066147	CH066147	-	-	64	147
CM066160	CH066160	-	-	69	160
CM066173	-	-	-	75	173
CM066200	-	-	-	86	200

Winding Information

AWG Wire No.	Single Layer Dia(cm)	Turn	Rdc, Ω	AWG Wire No.	Single Layer Dia(cm)	Turn	Rdc, Ω
25	0.0505	10	0.0180	34	0.0191	30	0.330
26	0.0452	11	0.0249	35	0.0170	34	0.461
27	0.0409	13	0.0341	36	0.0152	38	0.637
28	0.0366	14	0.0474	37	0.0140	42	0.862
29	0.0330	16	0.0642	38	0.0124	47	1.21
30	0.0294	19	0.0902	39	0.0109	54	1.78
31	0.0267	21	0.124	40	0.0096	61	2.53
32	0.0241	23	0.167	41	0.00863	68	3.43
33	0.0216	26	0.233	42	0.00762	77	4.81

Single layer winding with 1 inch leads

■ A_L vs NI Curve (60μ, 125μ)

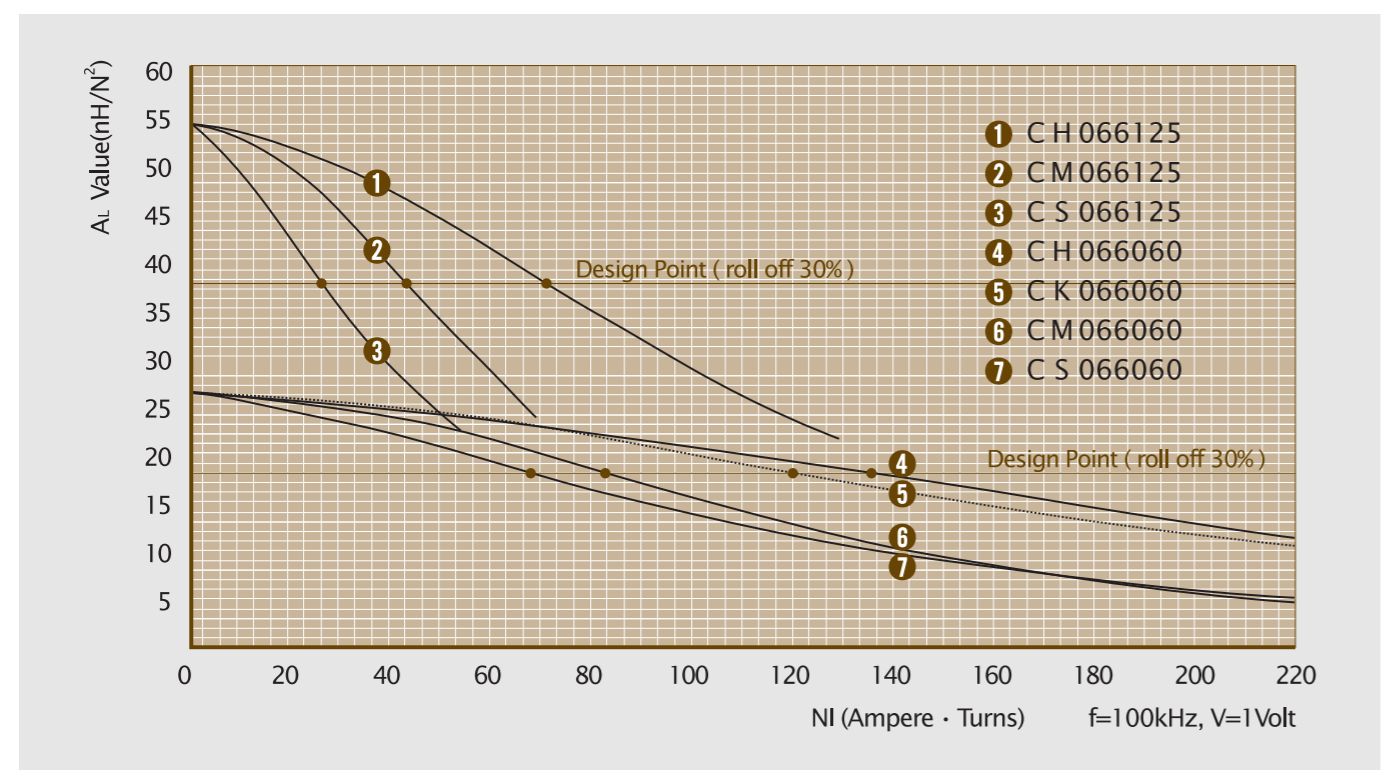

OD067

OD 6.6mm / 0.260inch

ID 2.67mm
HT 4.78mm



Core Dimensions

		OD(max)	ID(min)	HT(max)
Before coating	(mm)	6.6	2.67	4.78
	(inch)	0.260	0.105	0.188
After coating (Epoxy)	(mm)	7.32	2.21	5.54
	(inch)	0.288	0.087	0.218

Magnetic Dimensions

Cross Section (A)	Path Length (l)	Window Area (Wa)	Volume (V)
0.0920cm ²	1.363cm	0.0384cm ²	0.1254cm ³
0.01426in ²	0.537in	7,570cmil	0.007443in ³

Winding Information

AWG Wire No.	Single Layer Dia(cm)	Turn	Rdc, Ω	AWG Wire No.	Single Layer Dia(cm)	Turn	Rdc, Ω
25	0.0505	9	0.0223	34	0.0191	29	0.440
26	0.0452	11	0.0312	35	0.0170	32	0.617
27	0.0409	12	0.0431	36	0.0152	36	0.857
28	0.0366	14	0.0605	37	0.0140	40	1.17
29	0.0330	16	0.0826	38	0.0124	45	1.64
30	0.0294	18	0.117	39	0.0109	52	2.42
31	0.0267	20	0.162	40	0.0096	59	3.46
32	0.0241	22	0.220	41	0.00863	66	4.70
33	0.0216	25	0.309	42	0.00762	74	6.62

Single layer winding with 1 inch leads

Available Cores

Part No.				A _L	Perm.
MPP	High Flux	Sendust	Mega Flux [®]	(nH/N ²)	(μ)
CM067026	CH067026	-	-	21	26
CM067060	CH067060	CS067060	CK067060	50	60
-	-	CS067075	CK067075	62	75
-	-	CS067090	CK067090	74	90
CM067125	CH067125	CS067125	-	103	125
CM067147	CH067147	-	-	122	147
CM067160	CH067160	-	-	132	160
CM067173	-	-	-	144	173
CM067200	-	-	-	165	200

■ A_L vs NI Curve (60μ, 125μ)

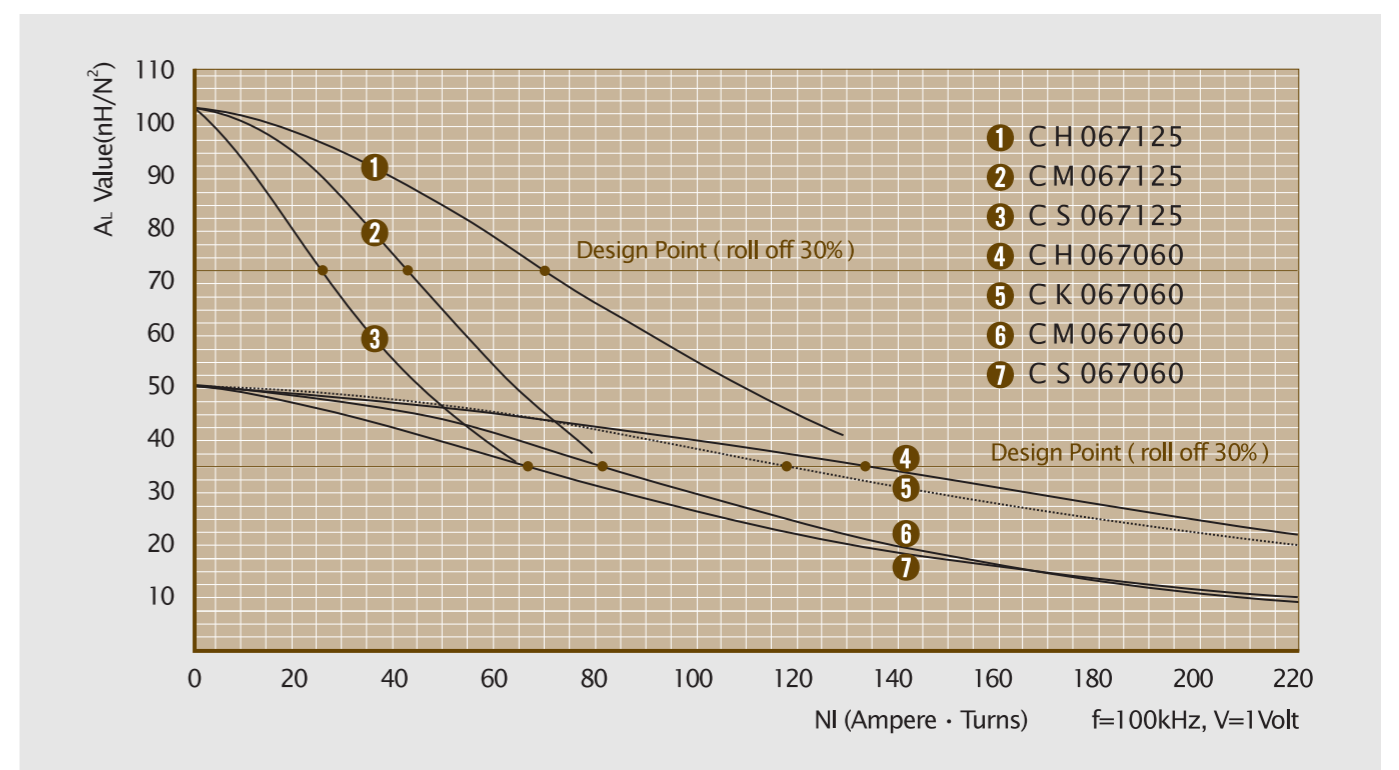

OD068

OD 6.86mm / 0.270inch

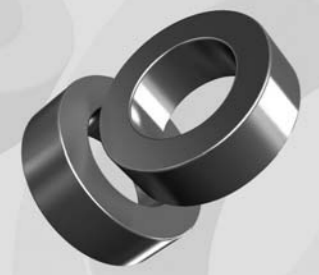

ID 3.96mm
HT 5.08mm

Core Dimensions

		OD(max)	ID(min)	HT(max)
Before coating	(mm)	6.86	3.96	5.08
	(inch)	0.270	0.156	0.200
After coating (Epoxy)	(mm)	7.62	3.45	5.72
	(inch)	0.300	0.136	0.225

Magnetic Dimensions

Cross Section (A)	Path Length (l)	Window Area (Wa)	Volume (V)
0.0725cm ²	1.65cm	0.0934cm ²	0.126009cm ³
0.01124in ²	0.650in	18,500cmil	0.007693in ³

Available Cores

MPP	Part No.			AL (nH/N ²)	Perm. (μ)
	High Flux	Sendust	Mega Flux [®]		
CM068026	CH068026	-	-	14	26
CM068060	CH068060	CS068060	CK068060	33	60
-	-	CS068075	CK068075	42	75
-	-	CS068090	CK068090	50	90
CM068125	CH068125	CS068125	-	70	125
CM068147	CH068147	-	-	81	147
CM068160	CH068160	-	-	89	160
CM068173	-	-	-	95	173
CM068200	-	-	-	112	200

Winding Information

AWG Wire No.	Single Layer Dia(cm)	Turn	Rdc, Ω	AWG Wire No.	Single Layer Dia(cm)	Turn	Rdc, Ω
21	0.0785	9	0.00902	30	0.0294	29	0.177
22	0.0701	11	0.0126	31	0.0267	33	0.244
23	0.0632	12	0.0174	32	0.0241	36	0.331
24	0.0566	14	0.0242	33	0.0216	41	0.466
25	0.0505	16	0.0338	34	0.0191	46	0.664
26	0.0452	18	0.0472	35	0.0170	52	0.932
27	0.0409	21	0.0651	36	0.0152	58	1.29
28	0.0366	23	0.0915	37	0.0140	65	1.76
29	0.0330	26	0.125	38	0.0124	73	2.48

Single layer winding with 1 inch leads

AL vs NI Curve (60μ, 125μ)

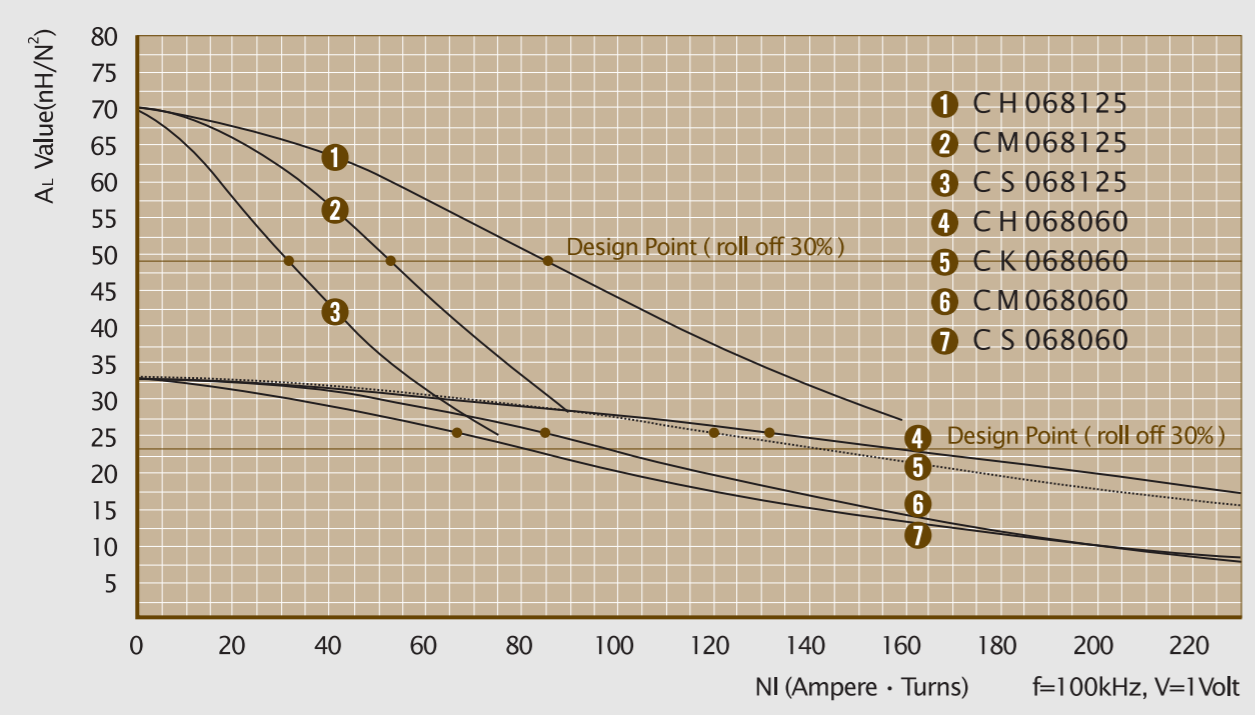

OD078

OD 7.87mm / 0.310inch

ID 3.96mm
HT 3.18mm



Core Dimensions

		OD(max)	ID(min)	HT(max)
Before coating	(mm)	7.87	3.96	3.18
	(inch)	0.310	0.156	0.125
After coating (Epoxy)	(mm)	8.51	3.43	3.81
	(inch)	0.335	0.135	0.150

Magnetic Dimensions

Cross Section (A)	Path Length (l)	Window Area (Wa)	Volume (V)
0.0615cm ²	1.787cm	0.0922cm ²	0.1099cm ³
0.00953in ²	0.704in	18,200cmil	0.0067in ³

Winding Information

AWG Wire No.	Single Layer Dia(cm)	Turn	Rdc, Ω	AWG Wire No.	Single Layer Dia(cm)	Turn	Rdc, Ω
21	0.0785	9	0.0078	30	0.0294	29	0.146
22	0.0701	11	0.0108	31	0.0267	33	0.201
23	0.0632	12	0.0148	32	0.0241	36	0.272
24	0.0566	14	0.0206	33	0.0216	41	0.382
25	0.0505	16	0.0285	34	0.0191	46	0.543
26	0.0452	18	0.0397	35	0.0170	52	0.760
27	0.0409	20	0.0545	36	0.0152	58	1.05
28	0.0366	23	0.0762	37	0.0140	64	1.43
29	0.0330	26	0.104	38	0.0124	72	2.01

Single layer winding with 1 inch leads

Available Cores

MPP	Part No.			AL (nH/N ²)	Perm. (μ)
	High Flux	Sendust	Mega Flux [®]		
CM078026	CH078026	-	-	11	26
CM078060	CH078060	CS078060	CK078060	25	60
-	-	CS078075	CK078075	31	75
-	-	CS078090	CK078090	37	90
CM078125	CH078125	CS078125	-	52	125
CM078147	CH078147	-	-	62	147
CM078160	CH078160	-	-	66	160
CM078173	-	-	-	73	173
CM078200	-	-	-	83	200

AL vs NI Curve (60μ, 125μ)

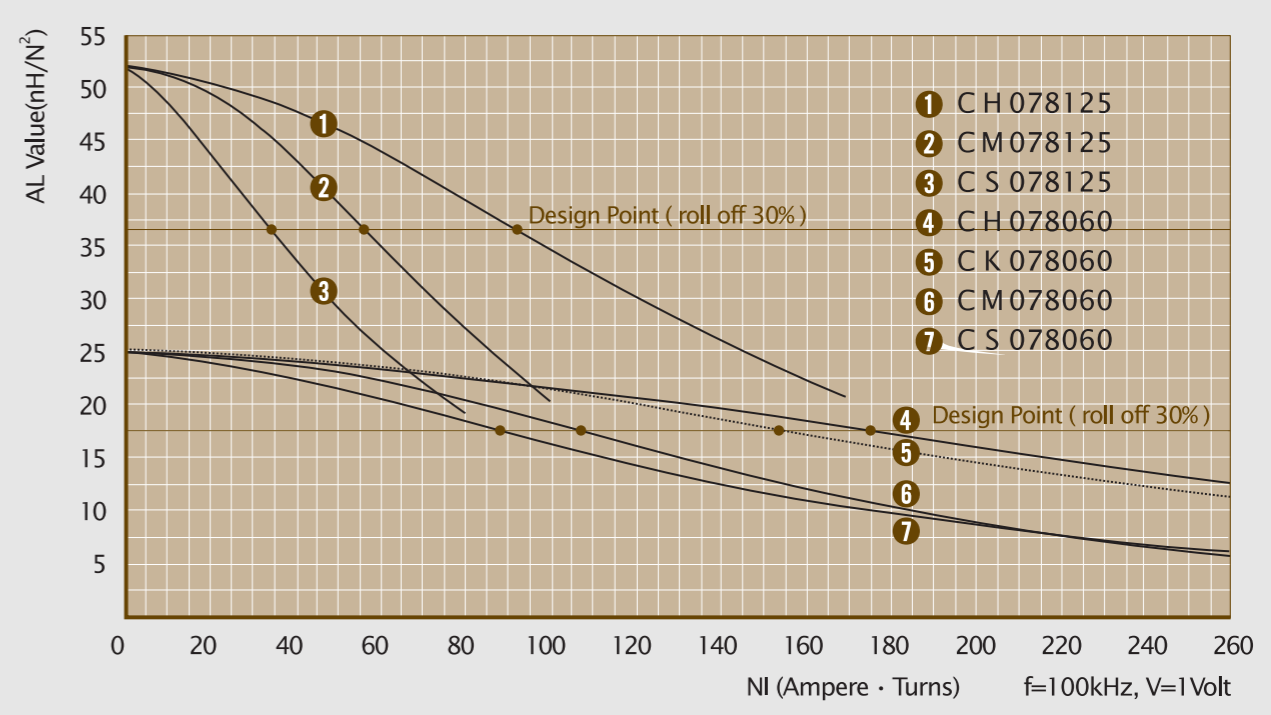

OD096

OD 9.65mm / 0.380inch

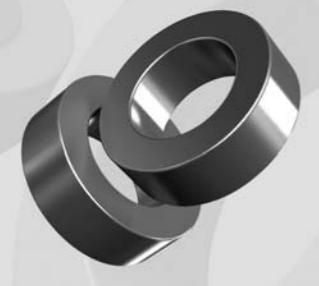

ID 4.78mm
HT 3.18mm

Core Dimensions

		OD(max)	ID(min)	HT(max)
Before coating	(mm)	9.65	4.78	3.18
	(inch)	0.380	0.188	0.125
After coating (Epoxy)	(mm)	10.29	4.27	3.81
	(inch)	0.405	0.168	0.150

Magnetic Dimensions

Cross Section (A)	Path Length (l)	Window Area (Wa)	Volume (V)
0.0752cm ²	2.18cm	0.1429cm ²	0.1639cm ³
0.01166in ²	0.859in	28,200cmil	0.0100in ³

Available Cores

MPP	Part No.			AL	Perm.
	High Flux	Sendust	Mega Flux®		
CM096026	CH096026	-	-	11	26
CM096060	CH096060	CS096060	CK096060	25	60
-	-	CS096075	CK096075	32	75
-	-	CS096090	CK096090	38	90
CM096125	CH096125	CS096125	-	53	125
CM096147	CH096147	-	-	63	147
CM096160	CH096160	-	-	68	160
CM096173	-	-	-	74	173
CM096200	-	-	-	84	200

Winding Information

AWG Wire No.	Single Layer Dia(cm)	Turn	Rdc, Ω	AWG Wire No.	Single Layer Dia(cm)	Turn	Rdc, Ω
19	0.0980	9	0.0053	28	0.0366	29	0.100
20	0.0879	11	0.0073	29	0.0330	33	0.136
21	0.0785	12	0.0101	30	0.0294	37	0.193
22	0.0701	14	0.0141	31	0.0267	41	0.266
23	0.0632	16	0.0193	32	0.0241	46	0.360
24	0.0566	18	0.0268	33	0.0216	51	0.505
25	0.0505	21	0.0372	34	0.0191	58	0.719
26	0.0452	23	0.0519	35	0.0170	65	1.01
27	0.0409	26	0.0714	36	0.0152	73	1.40

Single layer winding with 1 inch leads

AL vs NI Curve (60μ, 125μ)

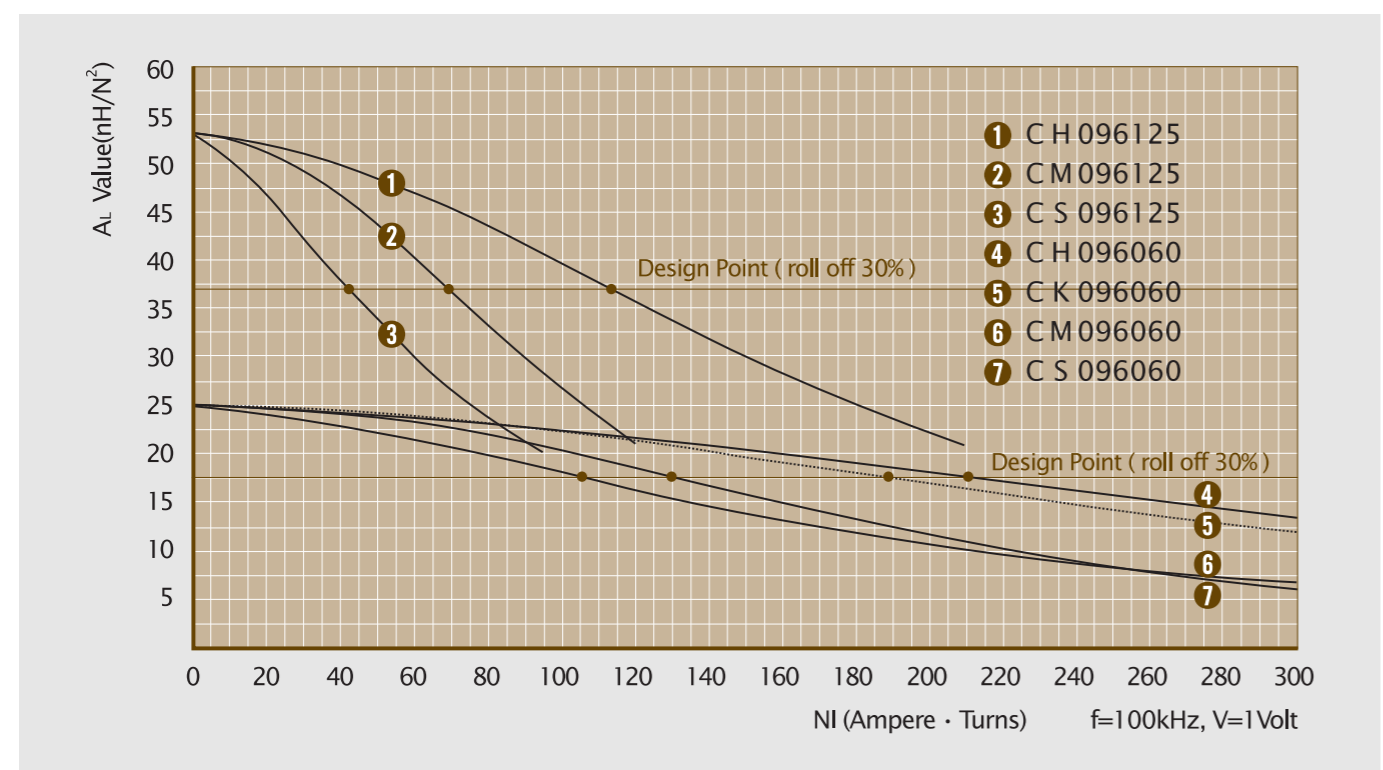

OD097

OD 9.65mm / 0.380inch

ID 4.78mm
HT 3.96mm



Core Dimensions

		OD(max)	ID(min)	HT(max)
Before coating	(mm)	9.65	4.78	3.96
	(inch)	0.380	0.188	0.156
After coating (Epoxy)	(mm)	10.29	4.27	4.57
	(inch)	0.405	0.168	0.180

Magnetic Dimensions

Cross Section (A)	Path Length (l)	Window Area (Wa)	Volume (V)
0.0945cm ²	2.18cm	0.1429cm ²	0.2060cm ³
0.01465in ²	0.859in	28,200cmil	0.01258in ³

Winding Information

AWG Wire No.	Single Layer Dia(cm)	Turn	Rdc, Ω	AWG Wire No.	Single Layer Dia(cm)	Turn	Rdc, Ω
19	0.0980	9	0.00567	28	0.0366	29	0.110
20	0.0879	11	0.00783	29	0.0330	33	0.150
21	0.0785	12	0.0109	30	0.0294	37	0.212
22	0.0701	14	0.0152	31	0.0267	41	0.293
23	0.0632	16	0.0209	32	0.0241	46	0.397
24	0.0566	18	0.0291	33	0.0216	51	0.558
25	0.0505	21	0.0405	34	0.0191	58	0.795
26	0.0452	23	0.0567	35	0.0170	65	1.12
27	0.0409	26	0.0782	36	0.0152	73	1.55

Single layer winding with 1 inch leads

Available Cores

MPP	Part No.			AL	Perm.
	High Flux	Sendust	Mega Flux®		
CM097026	CH097026	-	-	14	26
CM097060	CH097060	CS097060	CK097060	32	60
-	-	CS097075	CK097075	40	75
-	-	CS097090	CK097090	48	90
CM097125	CH097125	CS097125	-	66	125
CM097147	CH097147	-	-	78	147
CM097160	CH097160	-	-	84	160
CM097173	-	-	-	92	173
CM097200	-	-	-	105	200

AL vs NI Curve (60μ, 125μ)

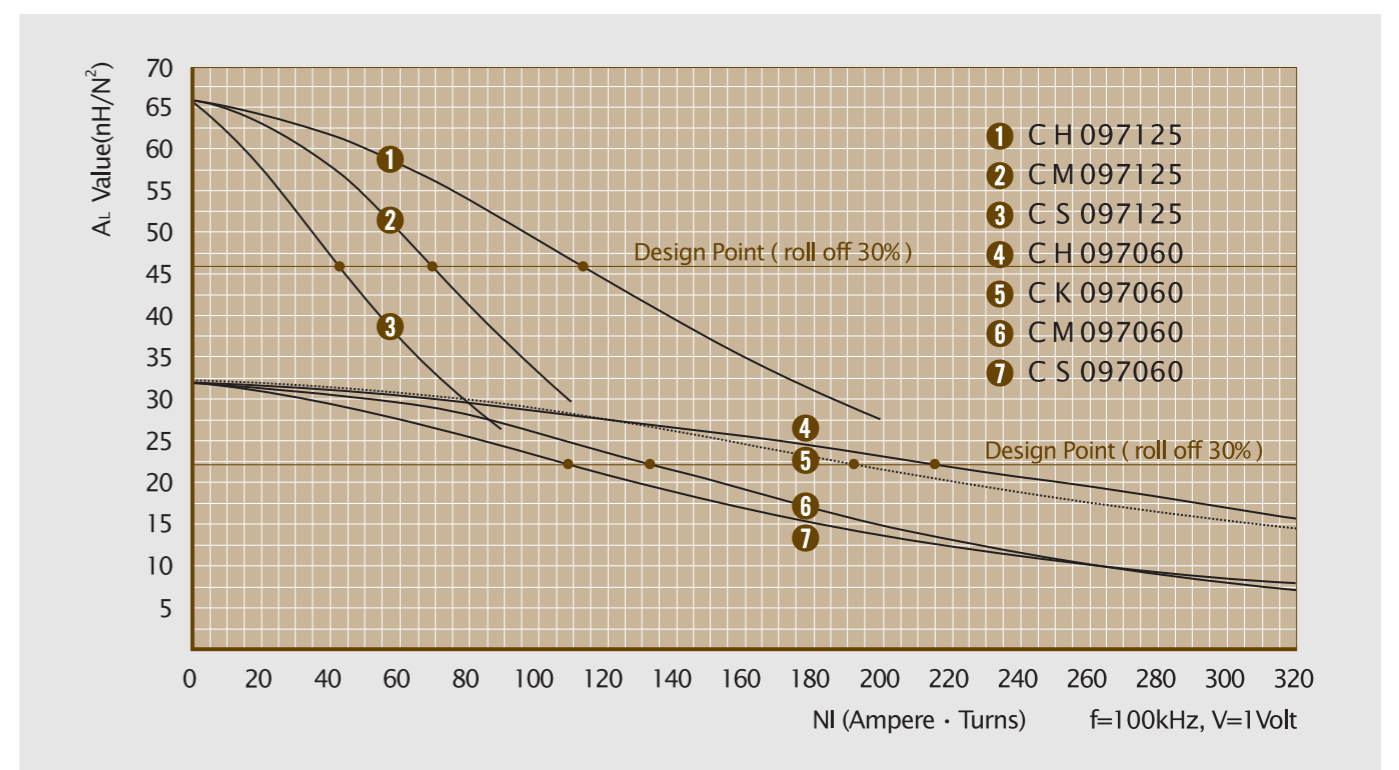

OD 102

OD 10.16mm / 0.400inch



ID 5.08mm
HT 3.96mm

Core Dimensions

		OD(max)	ID(min)	HT(max)
Before coating	(mm)	10.16	5.08	3.96
	(inch)	0.400	0.200	0.156
After coating (Epoxy)	(mm)	10.80	4.57	4.57
	(inch)	0.425	0.180	0.180

Magnetic Dimensions

Cross Section (A)	Path Length (l)	Window Area (Wa)	Volume (V)
0.1000cm ²	2.38cm	0.164cm ²	0.2380cm ³
0.01550in ²	0.906in	32,400cmil	0.0140in ³

Available Cores

Part No.				A _L	Perm.
MPP	High Flux	Sendust	Mega Flux®	(nH/N ²)	(μ)
CM102026	CH102026	-	-	14	26
CM102060	CH102060	CS102060	CK102060	32	60
-	-	CS102075	CK102075	40	75
-	-	CS102090	CK102090	48	90
CM102125	CH102125	CS102125	-	66	125
CM102147	CH102147	-	-	78	147
CM102160	CH102160	-	-	84	160
CM102173	-	-	-	92	173
CM102200	-	-	-	105	200

Winding Information

AWG Wire No.	Single Layer Dia(cm)	Turn	Rdc, Ω	AWG Wire No.	Single Layer Dia(cm)	Turn	Rdc, Ω
18	0.109	9	0.00442	27	0.0409	28	0.0846
19	0.0980	10	0.00613	28	0.0366	32	0.119
20	0.0879	12	0.00847	29	0.0330	35	0.162
21	0.0785	13	0.0118	30	0.0294	40	0.230
22	0.0701	15	0.0164	31	0.0267	44	0.317
23	0.0632	17	0.0226	32	0.0241	49	0.430
24	0.0566	20	0.0315	33	0.0216	55	0.605
25	0.0505	22	0.0439	34	0.0191	62	0.862
26	0.0452	25	0.0614	35	0.0170	70	1.21

Single layer winding with 1 inch leads

■ A_L vs NI Curve (60μ, 125μ)

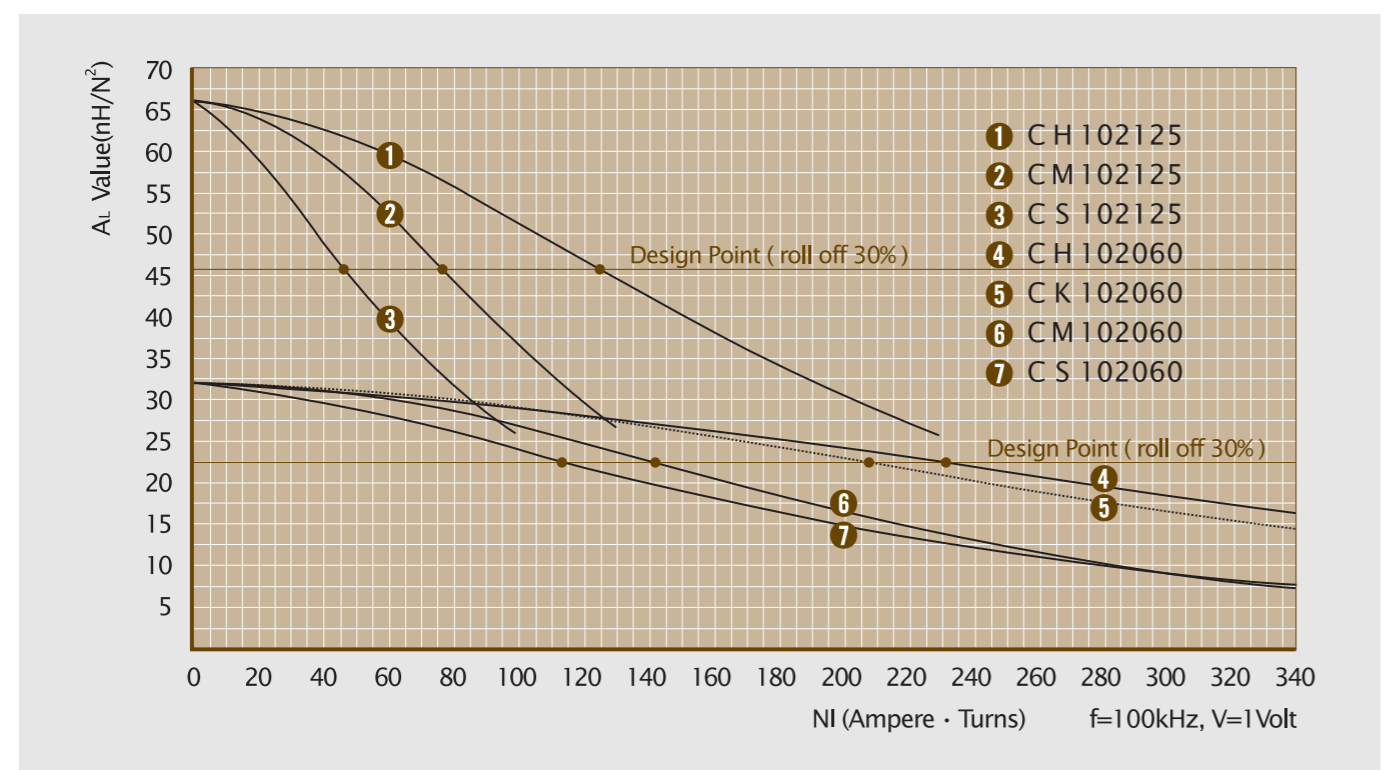

OD 112

OD 11.18mm / 0.440inch



ID 6.35mm
HT 3.96mm

Core Dimensions

		OD(max)	ID(min)	HT(max)
Before coating	(mm)	11.18	6.35	3.96
	(inch)	0.440	0.250	0.156
After coating (Epoxy)	(mm)	11.90	5.89	4.72
	(inch)	0.468	0.232	0.186

Magnetic Dimensions

Cross Section (A)	Path Length (l)	Window Area (Wa)	Volume (V)
0.0906cm ²	2.69cm	0.273cm ²	0.2437cm ³
0.01403in ²	1.08in	53,800cmil	0.01515in ³

Winding Information

AWG Wire No.	Single Layer Dia(cm)	Turn	Rdc, Ω	AWG Wire No.	Single Layer Dia(cm)	Turn	Rdc, Ω
16	0.137	9	0.00299	25	0.0505	29	0.0566
17	0.122	11	0.00412	26	0.0452	33	0.0792
18	0.109	12	0.00572	27	0.0409	37	0.109
19	0.0980	14	0.00792	28	0.0366	42	0.153
20	0.0879	16	0.0109	29	0.0330	46	0.209
21	0.0785	18	0.0152	30	0.0294	52	0.297
22	0.0701	21	0.0212	31	0.0267	58	0.410
23	0.0632	23	0.0292	32	0.0241	64	0.556
24	0.0566	26	0.0406	33	0.0216	72	0.782

Single layer winding with 1 inch leads

Available Cores

Part No.				A _L	Perm.
MPP	High Flux	Sendust	Mega Flux®	(nH/N ²)	(μ)
CM112026	CH112026	CS112026	CK112026	11	26
CM112060	CH112060	CS112060	CK112060	26	60
-	-	CS112075	CK112075	32	75
-	-	CS112090	CK112090	38	90
CM112125	CH112125	CS112125	-	53	125
CM112147	CH112147	-	-	63	147
CM112160	CH112160	-	-	68	160
CM112173	-	-	-	74	173
CM112200	-	-	-	85	200

■ A_L vs NI Curve (60μ, 125μ)

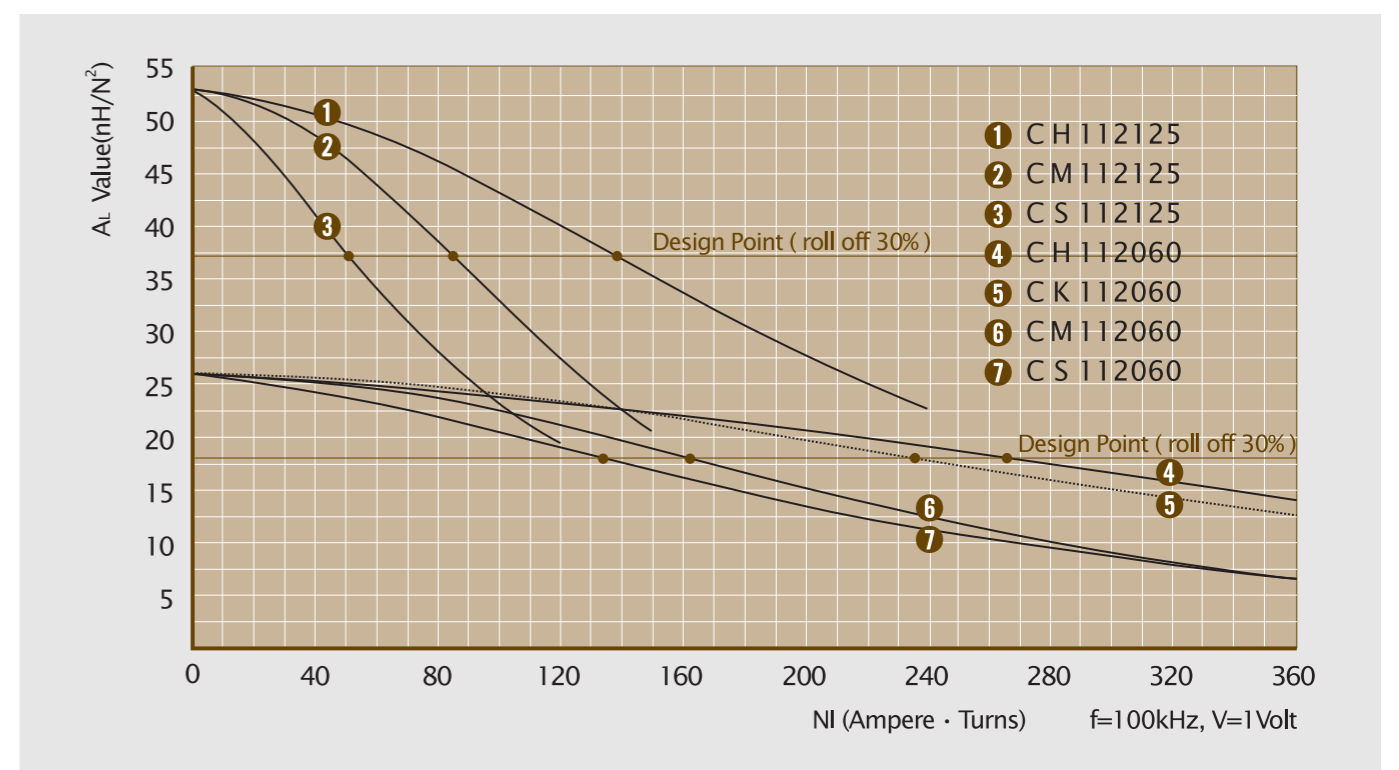

OD 127

OD 12.70mm / 0.500inch

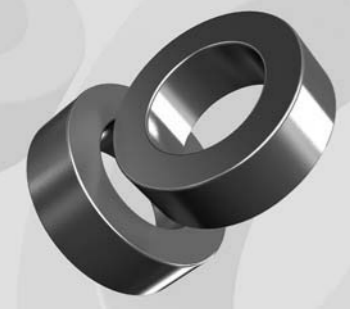

ID 7.62mm
HT 4.75mm

Core Dimensions

		OD(max)	ID(min)	HT(max)
Before coating	(mm)	12.70	7.62	4.75
	(inch)	0.500	0.300	0.187
After coating (Epoxy)	(mm)	13.46	6.99	5.51
	(inch)	0.530	0.275	0.217

Magnetic Dimensions

Cross Section (A)	Path Length (l)	Window Area (Wa)	Volume (V)
0.114cm ²	3.12cm	0.383cm ²	0.35568cm ³
0.01767in ²	1.229in	75,600cmil	0.002172in ³

Available Cores

MPP	Part No.				AL (nH/N ²)	Perm. (μ)
	High Flux	Sendust	Mega Flux [®]			
CM127026	CH127026	CS127026	CK127026		12	26
CM127060	CH127060	CS127060	CK127060		27	60
-	-	CS127075	CK127075		34	75
-	-	CS127090	CK127090		40	90
CM127125	CH127125	CS127125	-		56	125
CM127147	CH127147	-	-		67	147
CM127160	CH127160	-	-		72	160
CM127173	-	-	-		79	173
CM127200	-	-	-		90	200

Winding Information

AWG Wire		Single Layer		AWG Wire		Single Layer	
No.	Dia(cm)	Turn	Rdc, Ω	No.	Dia(cm)	Turn	Rdc, Ω
15	0.153	10	0.00271	24	0.0566	31	0.0518
16	0.137	11	0.00376	25	0.0505	35	0.0723
17	0.122	13	0.00520	26	0.0452	40	0.101
18	0.109	15	0.00722	27	0.0409	45	0.140
19	0.0980	17	0.0100	28	0.0366	50	0.197
20	0.0879	19	0.0139	29	0.0330	56	0.269
21	0.0785	22	0.0193	30	0.0294	63	0.381
22	0.0701	25	0.0270	31	0.0267	69	0.527
23	0.0632	28	0.0371	32	0.0241	77	0.716

Single layer winding with 1 inch leads

AL vs NI Curve (60μ, 125μ)

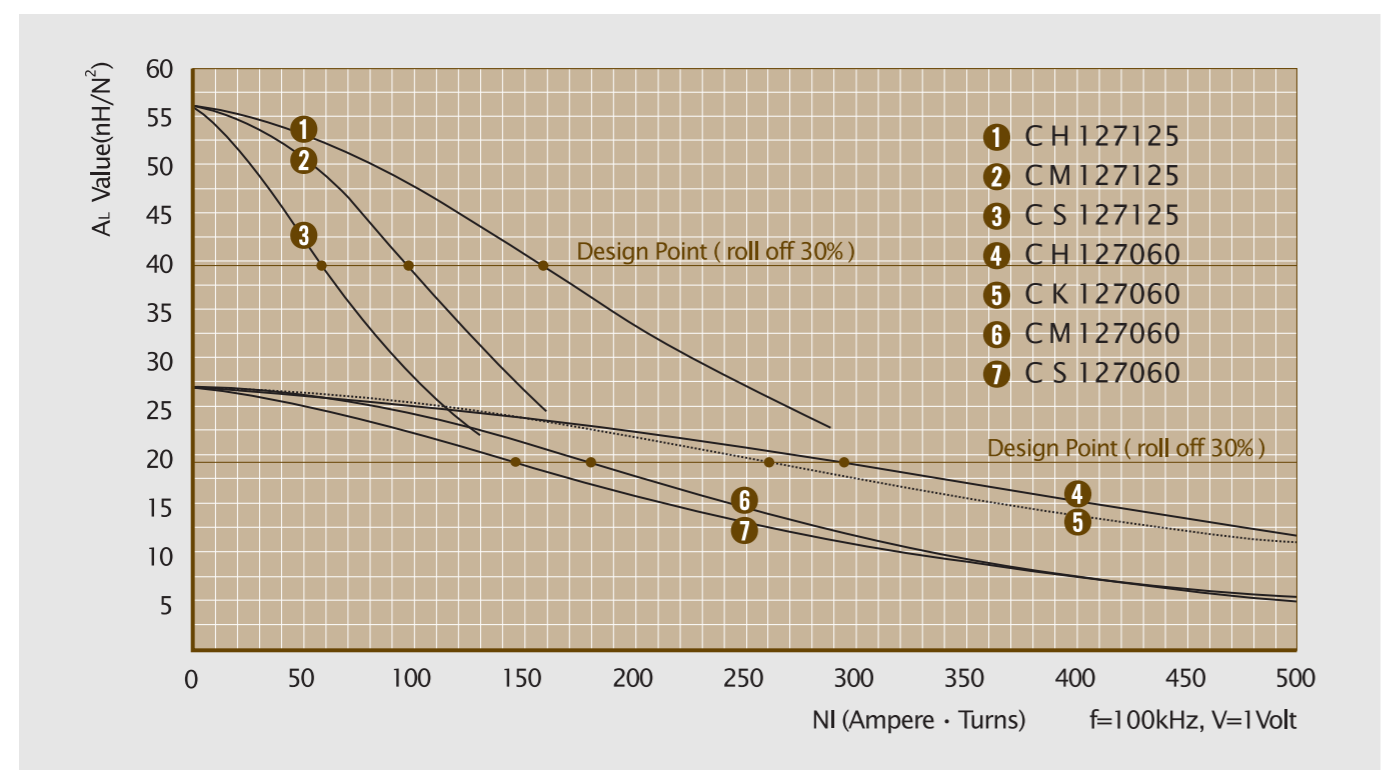

OD 166

OD 16.51mm / 0.650inch

ID 10.16mm
HT 6.35mm



Core Dimensions

		OD(max)	ID(min)	HT(max)
Before coating	(mm)	16.51	10.16	6.35
	(inch)	0.650	0.400	0.250
After coating (Epoxy)	(mm)	17.40	9.53	7.11
	(inch)	0.680	0.375	0.280

Magnetic Dimensions

Cross Section (A)	Path Length (l)	Window Area (Wa)	Volume (V)
0.1920cm ²	4.11cm	0.713cm ²	0.7891cm ³
0.0298in ²	1.619in	140,600cmil	0.0438in ³

Winding Information

AWG Wire		Single Layer		AWG Wire		Single Layer	
No.	Dia(cm)	Turn	Rdc, Ω	No.	Dia(cm)	Turn	Rdc, Ω
12	0.213	10	0.00165	21	0.0785	31	0.0323
13	0.190	11	0.00230	22	0.0701	35	0.0453
14	0.171	13	0.00318	23	0.0632	39	0.0626
15	0.153	15	0.00443	24	0.0566	44	0.0876
16	0.137	17	0.00617	25	0.0505	49	0.123
17	0.122	19	0.00856	26	0.0452	55	0.172
18	0.109	21	0.0119	27	0.0409	62	0.239
19	0.0980	24	0.0166	28	0.0366	69	0.336
20	0.0879	27	0.0231	29	0.0330	77	0.460

Single layer winding with 1 inch leads

Available Cores

MPP	Part No.				AL (nH/N ²)	Perm. (μ)
	High Flux	Sendust	Mega Flux [®]			
CM166026	CH166026	CS166026	CK166026	15	26	
CM166060	CH166060	CS166060	CK166060	35	60	
-	-	CS166075	CK166075	43	75	
-	-	CS166090	CK166090	52	90	
CM166125	CH166125	CS166125	-	72	125	
CM166147	CH166147	-	-	88	147	
CM166160	CH166160	-	-	92	160	
CM166173	-	-	-	104	173	
CM166200	-	-	-	115	200	

AL vs NI Curve (60μ, 125μ)

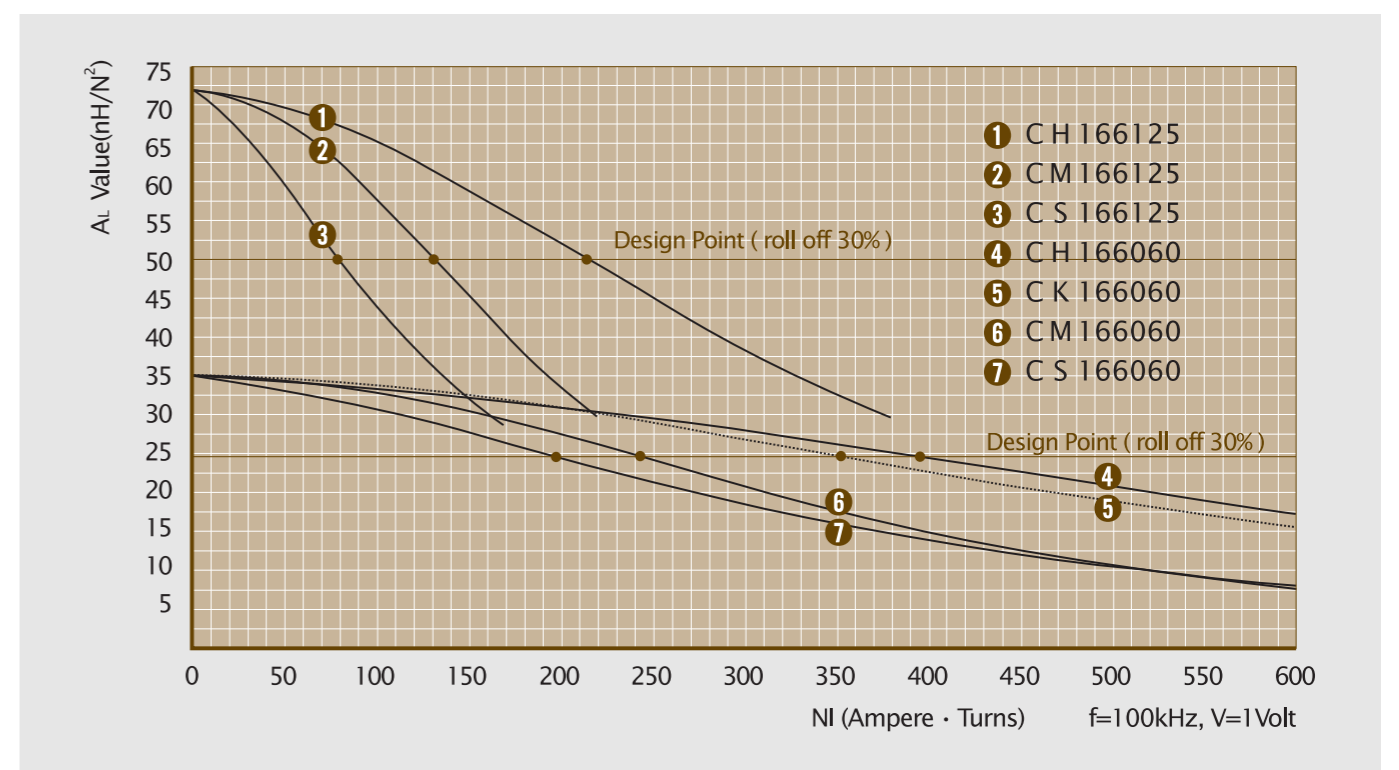

OD 172

OD 17.27mm / 0.680inch

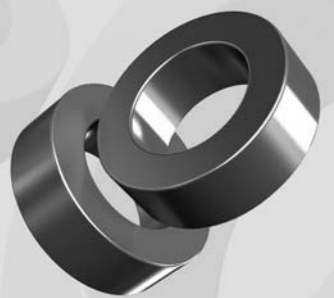

ID 9.65mm
HT 6.35mm

Core Dimensions

		OD(max)	ID(min)	HT(max)
Before coating	(mm)	17.27	9.65	6.35
	(inch)	0.680	0.380	0.250
After coating (Epoxy)	(mm)	18.03	9.02	7.11
	(inch)	0.710	0.355	0.280

Magnetic Dimensions

Cross Section (A)	Path Length (l)	Window Area (Wa)	Volume (V)
0.232cm ²	4.14cm	0.683cm ²	0.9605cm ³
0.0360in ²	1.63in	126,000cmil	0.05868in ³

Available Cores

MPP	Part No.				AL (nH/N ²)	Perm. (μ)
	High Flux	Sendust	Mega Flux [®]			
CM172026	CH172026	CS172026	CK172026	19	26	
CM172060	CH172060	CS172060	CK172060	43	60	
-	-	CS172075	CK172075	53	75	
-	-	CS172090	CK172090	64	90	
CM172125	CH172125	CS172125	-	89	125	
CM172147	CH172147	-	-	105	147	
CM172160	CH172160	-	-	114	160	
CM172173	-	-	-	123	173	
CM172200	-	-	-	142	200	

Winding Information

AWG Wire No.	Single Layer Dia(cm)	Turn	Rdc, Ω	AWG Wire No.	Single Layer Dia(cm)	Turn	Rdc, Ω
12	0.213	9	0.00161	21	0.0785	29	0.0319
13	0.190	10	0.00225	22	0.0701	33	0.0449
14	0.171	12	0.00311	23	0.0632	37	0.0621
15	0.153	14	0.00434	24	0.0566	41	0.0869
16	0.137	16	0.00606	25	0.0505	47	0.122
17	0.122	18	0.00843	26	0.0452	52	0.171
18	0.109	20	0.0118	27	0.0409	58	0.237
19	0.0980	23	0.0164	28	0.0366	65	0.334
20	0.0879	26	0.0228	29	0.0330	73	0.458

Single layer winding with 1 inch leads

AL vs NI Curve (60μ, 125μ)

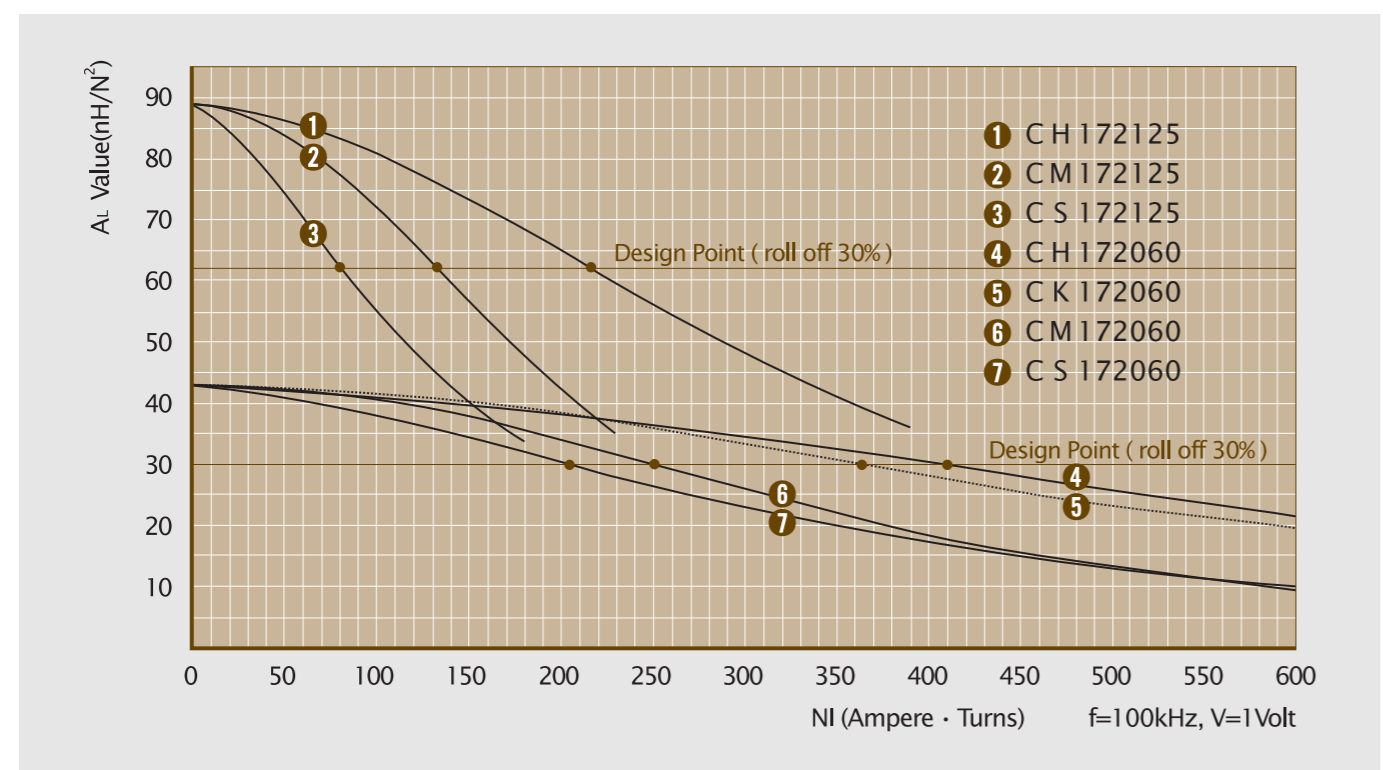

OD 203

OD 20.32mm / 0.800inch

ID 12.70mm
HT 6.35mm

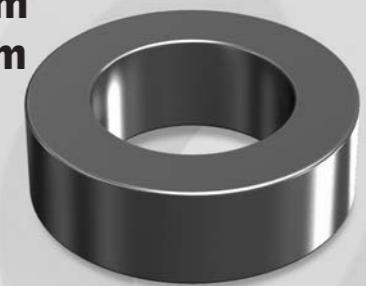

Core Dimensions

		OD(max)	ID(min)	HT(max)
Before coating	(mm)	20.32	12.70	6.35
	(inch)	0.800	0.500	0.250
After coating (Epoxy)	(mm)	21.1	12.07	7.11
	(inch)	0.830	0.475	0.280

Magnetic Dimensions

Cross Section (A)	Path Length (l)	Window Area (Wa)	Volume (V)
0.226cm ²	5.09cm	1.14cm ²	1.1510cm ³
0.035in ²	2.01in	225,600cmil	0.07035in ³

Winding Information

AWG Wire No.	Single Layer Dia(cm)	Turn	Rdc, Ω	AWG Wire No.	Single Layer Dia(cm)	Turn	Rdc, Ω
12	0.213	13	0.00221	21	0.0785	40	0.0430
13	0.190	15	0.00307	22	0.0701	45	0.0604
14	0.171	17	0.00424	23	0.0632	50	0.0834
15	0.153	19	0.00590	24	0.0566	56	0.117
16	0.137	22	0.00822	25	0.0505	63	0.164
17	0.122	25	0.0114	26	0.0452	71	0.230
18	0.109	28	0.0159	27	0.0409	79	0.318
19	0.0980	32	0.0222	28	0.0366	89	0.448
20	0.0879	35	0.0308	29	0.0330	98	0.614

Single layer winding with 1 inch leads

Available Cores

MPP	Part No.				AL (nH/N ²)	Perm. (μ)
	High Flux	Sendust	Mega Flux [®]			
CM203026	CH203026	CS203026	CK203026	14	26	
CM203060	CH203060	CS203060	CK203060	32	60	
-	-	CS203075	CK203075	41	75	
-	-	CS203090	CK203090	49	90	
CM203125	CH203125	CS203125	-	68	125	
CM203147	CH203147	-	-	81	147	
CM203160	CH203160	-	-	87	160	
CM203173	-	-	-	96	173	
CM203200	-	-	-	109	200	

AL vs NI Curve (60μ, 125μ)

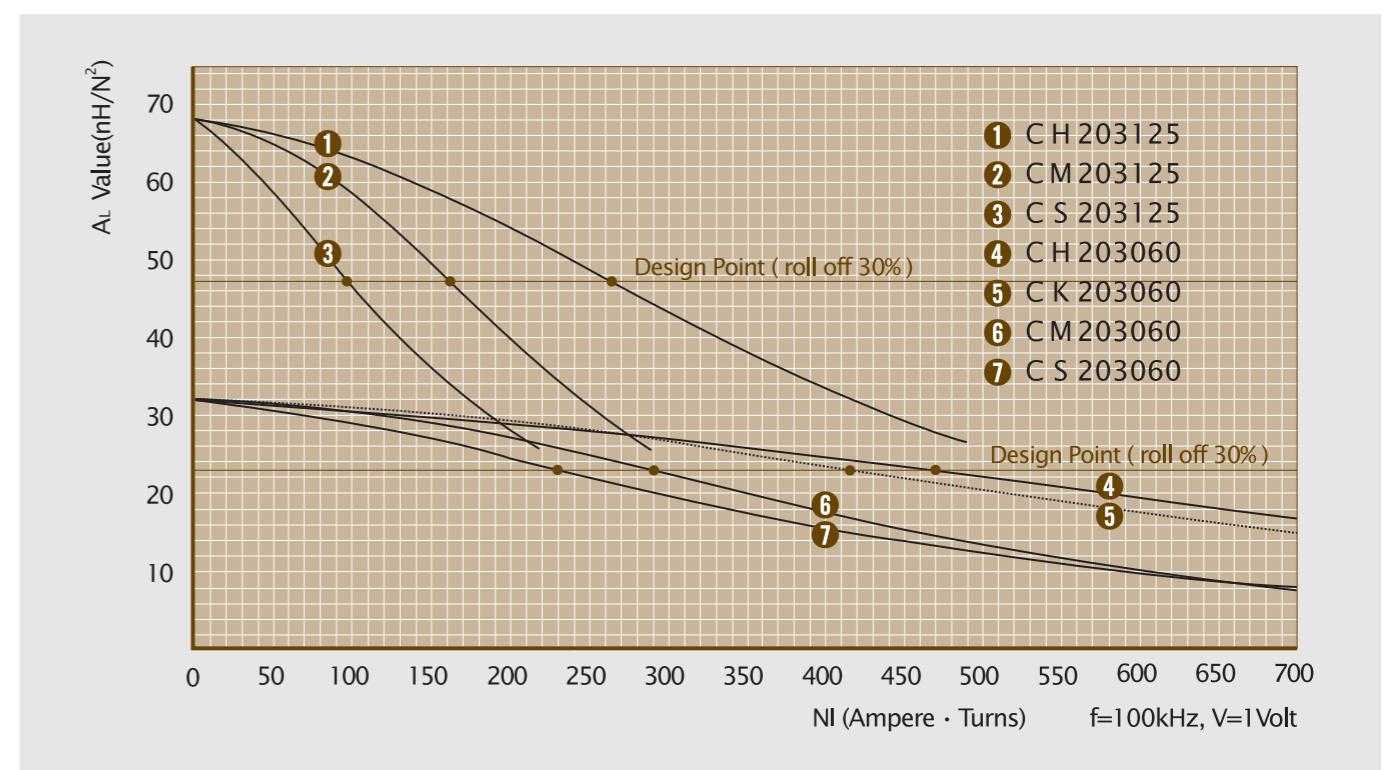

OD229

OD 22.86mm / 0.900inch

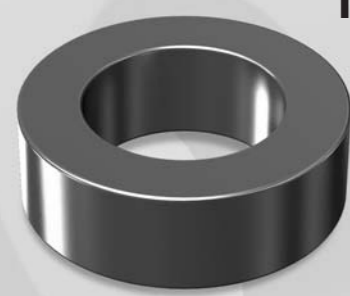

ID 13.97mm
HT 7.62mm

Core Dimensions

		OD(max)	ID(min)	HT(max)
Before coating	(mm)	22.86	13.97	7.62
	(inch)	0.900	0.550	0.300
After coating (Epoxy)	(mm)	23.62	13.39	8.38
	(inch)	0.930	0.527	0.330

Magnetic Dimensions

Cross Section (A)	Path Length (l)	Window Area (Wa)	Volume (V)
0.331cm ²	5.67cm	1.41cm ²	1.8771cm ³
0.0513in ²	2.23in	277,700cmil	0.11455in ³

Available Cores

MPP	Part No.				AL (nH/N ²)	Perm. (μ)
	High Flux	Sendust	Mega Flux [®]			
CM229026	CH229026	CS229026	CK229026	19	26	
CM229060	CH229060	CS229060	CK229060	43	60	
-	-	CS229075	CK229075	54	75	
-	-	CS229090	CK229090	65	90	
CM229125	CH229125	CS229125	-	90	125	
CM229147	CH229147	-	-	106	147	
CM229160	CH229160	-	-	115	160	
CM229173	-	-	-	124	173	
CM229200	-	-	-	144	200	

Winding Information

AWG Wire No.	Single Layer Dia(cm)	Turn	Rdc, Ω	AWG Wire No.	Single Layer Dia(cm)	Turn	Rdc, Ω
12	0.213	15	0.00276	21	0.0785	45	0.0548
13	0.190	17	0.00384	22	0.0701	50	0.0771
14	0.171	19	0.00532	23	0.0632	56	0.107
15	0.153	22	0.00742	24	0.0566	63	0.150
16	0.137	25	0.0104	25	0.0505	71	0.210
17	0.122	28	0.0144	26	0.0452	79	0.295
18	0.109	31	0.0202	27	0.0409	88	0.409
19	0.0980	35	0.0281	28	0.0366	99	0.577
20	0.0879	40	0.0392	29	0.0330	109	0.791

Single layer winding with 1 inch leads

AL vs NI Curve (60μ, 125μ)

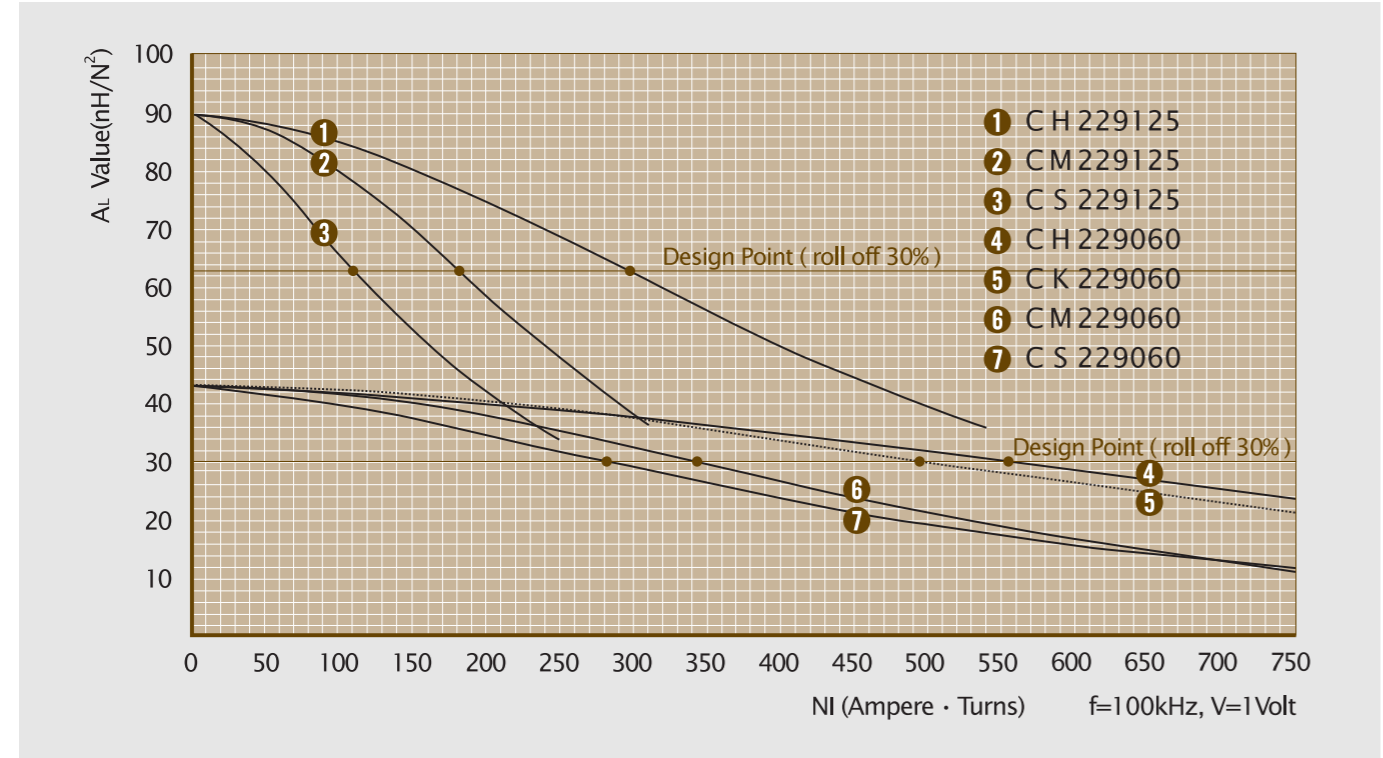

OD234

OD 23.57mm / 0.928inch



ID 14.40mm
HT 8.89mm

Core Dimensions

		OD(max)	ID(min)	HT(max)
Before coating	(mm)	23.57	14.40	8.89
	(inch)	0.928	0.567	0.350
After coating (Epoxy)	(mm)	24.30	13.77	9.70
	(inch)	0.956	0.542	0.382

Magnetic Dimensions

Cross Section (A)	Path Length (l)	Window Area (Wa)	Volume (V)
0.388cm ²	5.88cm	1.49cm ²	2.2814cm ³
0.061in ²	2.32in	293,800cmil	0.1415in ³

Winding Information

AWG Wire No.	Single Layer Dia(cm)	Turn	Rdc, Ω	AWG Wire No.	Single Layer Dia(cm)	Turn	Rdc, Ω
12	0.213	15	0.00307	21	0.0785	46	0.0620
13	0.190	17	0.00429	22	0.0701	52	0.0874
14	0.171	20	0.00595	23	0.0632	58	0.1210
15	0.153	22	0.00832	24	0.0566	65	0.170
16	0.137	25	0.0116	25	0.0505	73	0.238
17	0.122	29	0.0162	26	0.0452	81	0.336
18	0.109	32	0.0227	27	0.0409	91	0.465
19	0.0980	36	0.0318	28	0.0366	101	0.657
20	0.0879	41	0.0443	29	0.0330	112	0.901

Single layer winding with 1 inch leads

Available Cores

MPP	Part No.				AL (nH/N ²)	Perm. (μ)
	High Flux	Sendust	Mega Flux [®]			
CM234026	CH234026	CS234026	CK234026	22	26	
CM234060	CH234060	CS234060	CK234060	51	60	
-	-	CS234075	CK234075	63	75	
-	-	CS234090	CK234090	76	90	
CM234125	CH234125	CS234125	-	105	125	
CM234147	CH234147	-	-	124	147	
CM234160	CH234160	-	-	135	160	
CM234173	-	-	-	146	173	
CM234200	-	-	-	169	200	

AL vs NI Curve (60μ, 125μ)

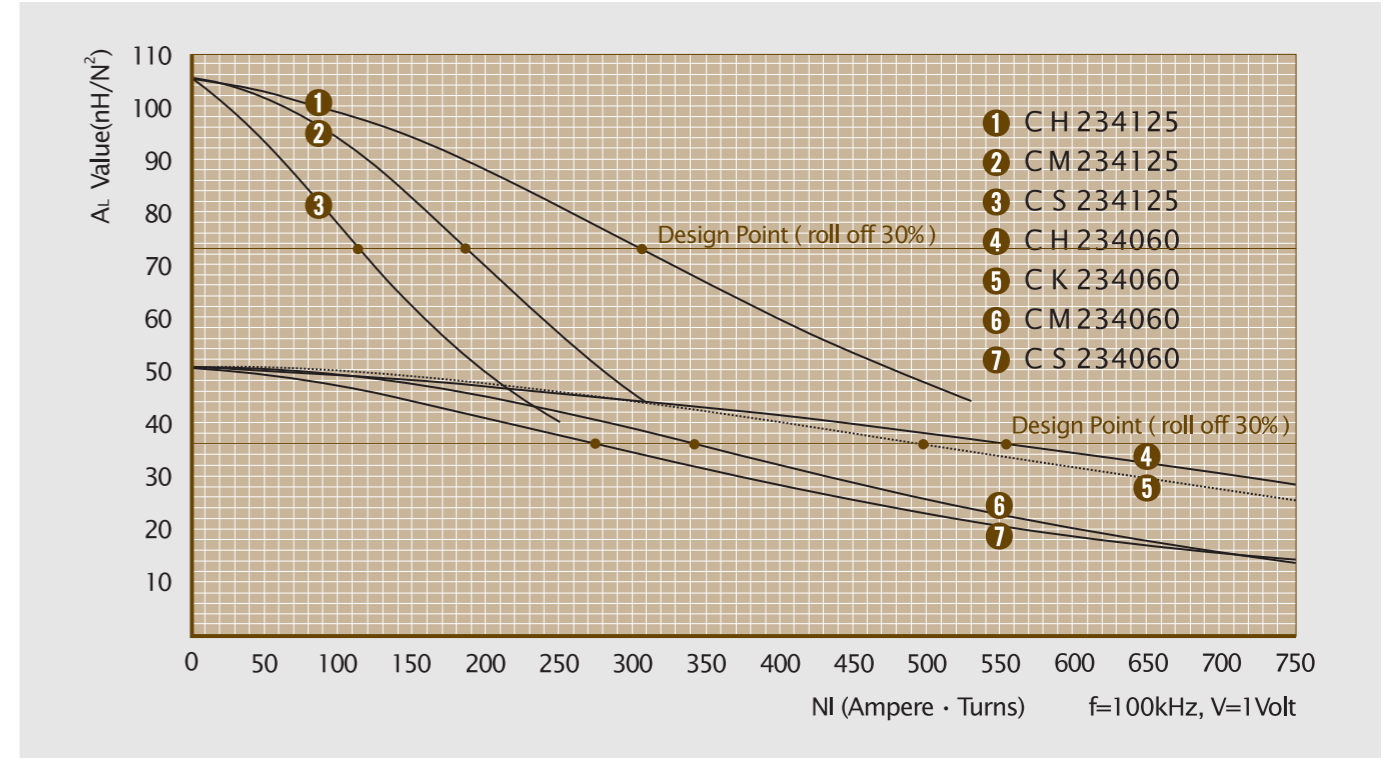

OD270

OD 26.92mm / 1.060inches



ID 14.73mm
HT 11.18mm

Core Dimensions

		OD(max)	ID(min)	HT(max)
Before coating	(mm)	26.92	14.73	11.18
	(inch)	1.060	0.580	0.440
After coating (Epoxy)	(mm)	27.70	14.10	11.99
	(inch)	1.090	0.555	0.472

Magnetic Dimensions

Cross Section (A)	Path Length (l)	Window Area (Wa)	Volume (V)
0.654cm ²	6.35cm	1.56cm ²	4.154cm ³
0.1014in ²	2.50in	308,000cmil	0.2536in ³

Available Cores

MPP	Part No.				AL (nH/N ²)	Perm. (μ)
	High Flux	Sendust	Mega Flux [®]			
CM270026	CH270026	CS270026	CK270026		32	26
CM270060	CH270060	CS270060	CK270060		75	60
-	-	CS270075	CK270075		94	75
-	-	CS270090	CK270090		113	90
CM270125	CH270125	CS270125	-		157	125
CM270147	CH270147	-	-		185	147
CM270160	CH270160	-	-		201	160
CM270173	-	-	-		217	173
CM270200	-	-	-		251	200

Winding Information

AWG Wire No.	Single Layer Dia(cm)	Turn	Rdc, Ω	AWG Wire No.	Single Layer Dia(cm)	Turn	Rdc, Ω
12	0.213	16	0.00367	21	0.0785	47	0.0759
13	0.190	18	0.00514	22	0.0701	53	0.107
14	0.171	20	0.00715	23	0.0632	59	0.149
15	0.153	23	0.0100	24	0.0566	66	0.209
16	0.137	26	0.0141	25	0.0505	74	0.294
17	0.122	29	0.0197	26	0.0452	83	0.414
18	0.109	33	0.0276	27	0.0409	93	0.575
19	0.0980	37	0.0387	28	0.0366	104	0.812
20	0.0879	42	0.0541	29	0.0330	115	1.11

Single layer winding with 1 inch leads

AL vs NI Curve (60μ, 125μ)

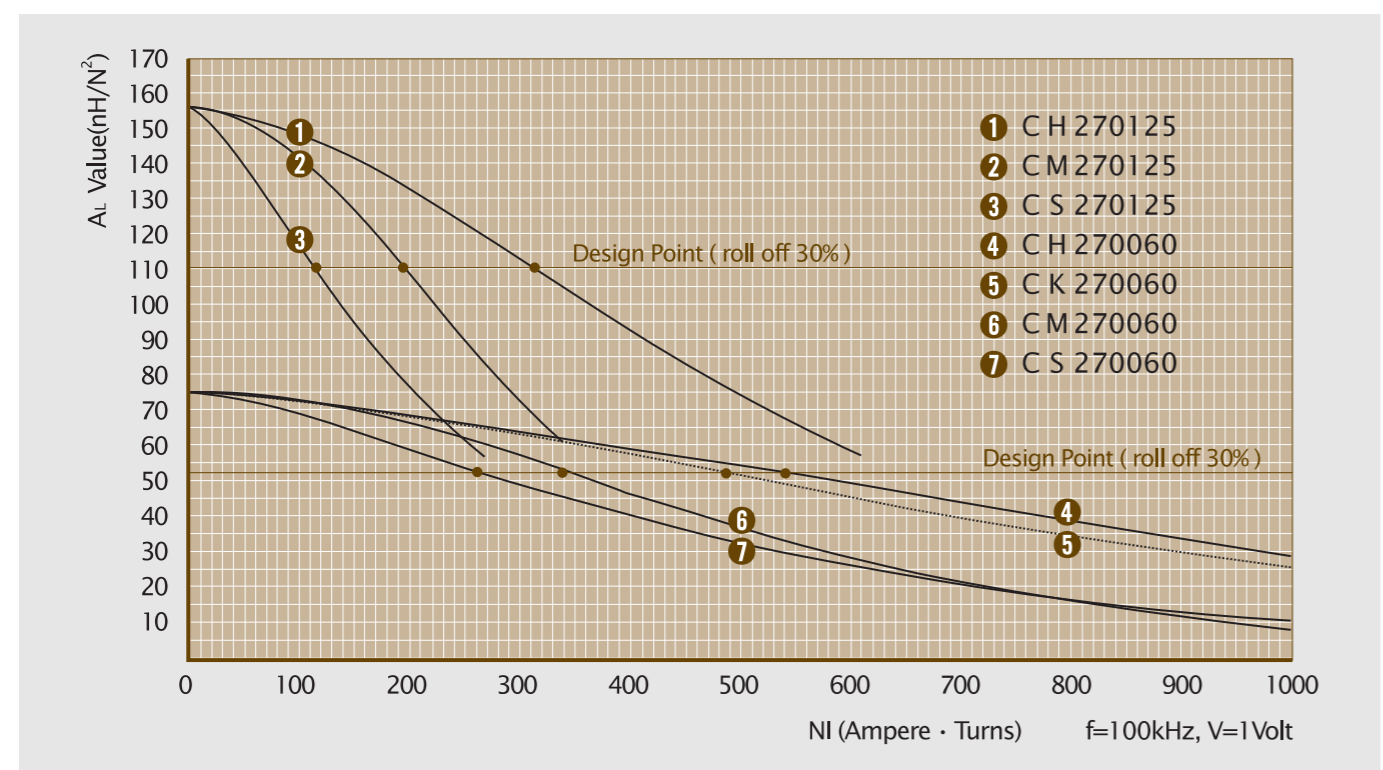

OD330

OD 33.02mm / 1.300inches



ID 19.94mm
HT 10.67mm

Core Dimensions

		OD(max)	ID(min)	HT(max)
Before coating	(mm)	33.02	19.94	10.67
	(inch)	1.300	0.785	0.420
After coating (Epoxy)	(mm)	33.83	19.30	11.61
	(inch)	1.332	0.760	0.457

Magnetic Dimensions

Cross Section (A)	Path Length (l)	Window Area (Wa)	Volume (V)
00.672cm ²	8.15cm	2.93cm ²	5.4768cm ³
0.1042in ²	3.21in	577,600cmil	0.3345in ³

Winding Information

AWG Wire No.	Single Layer Dia(cm)	Turn	Rdc, Ω	AWG Wire No.	Single Layer Dia(cm)	Turn	Rdc, Ω
12	0.213	23	0.00517	21	0.0785	66	0.105
13	0.190	26	0.00722	22	0.0701	74	0.148
14	0.171	29	0.0100	23	0.0632	82	0.206
15	0.153	32	0.0140	24	0.0566	92	0.289
16	0.137	37	0.0197	25	0.0505	103	0.406
17	0.122	41	0.0274	26	0.0452	115	0.572
18	0.109	46	0.0384	27	0.0409	128	0.794
19	0.0980	52	0.0538	28	0.0366	143	1.12
20	0.0879	58	0.0750	29	0.0330	159	1.54

Single layer winding with 1 inch leads

Available Cores

MPP	Part No.				AL (nH/N ²)	Perm. (μ)
	High Flux	Sendust	Mega Flux [®]			
CM330026	CH330026	CS330026	CK330026		28	26
CM330060	CH330060	CS330060	CK330060		61	60
-	-	CS330075	CK330075		76	75
-	-	CS330090	CK330090		91	90
CM330125	CH330125	CS330125	-		127	125
CM330147	CH330147	-	-		150	147
CM330160	CH330160	-	-		163	160
CM330173	-	-	-		176	173
-	-	-	-		203	200

AL vs NI Curve (60μ, 125μ)

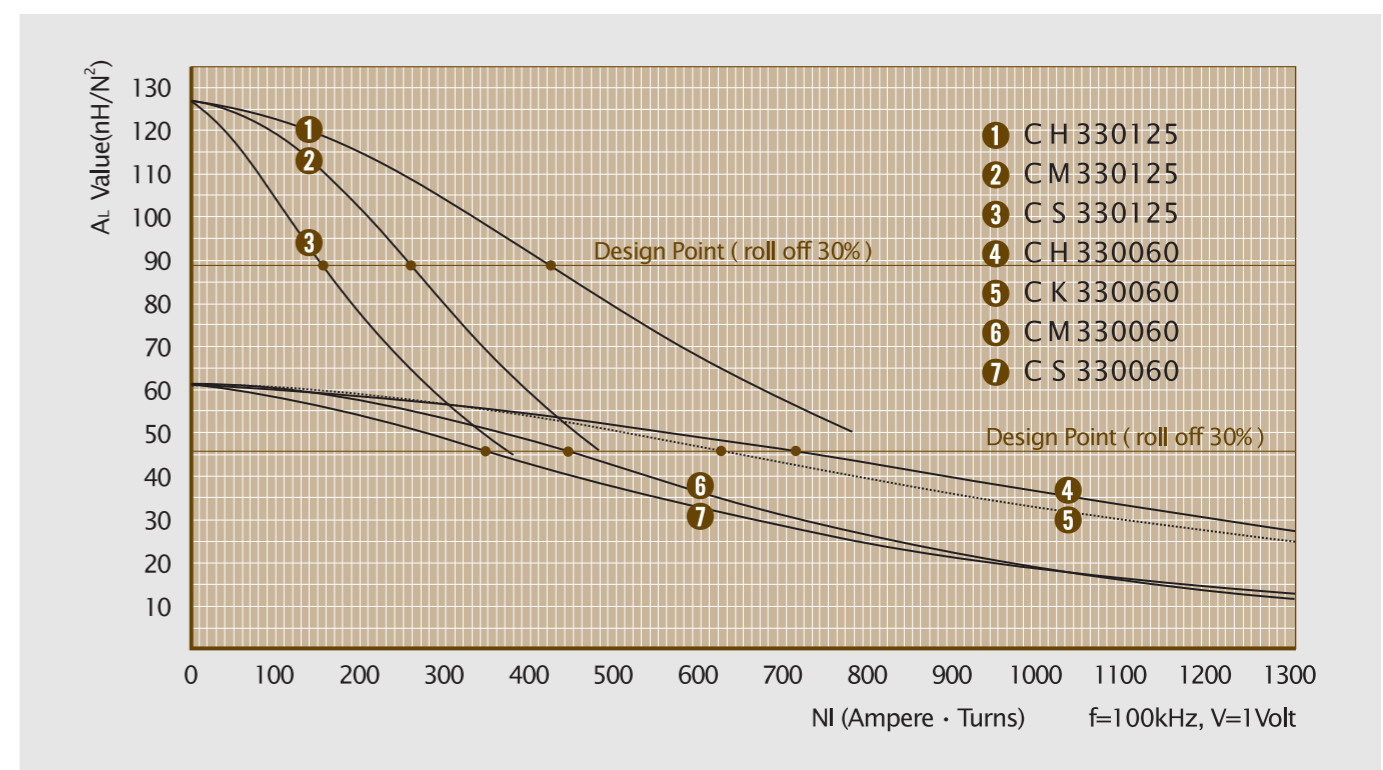

OD343

OD 34.29mm / 1.350inches

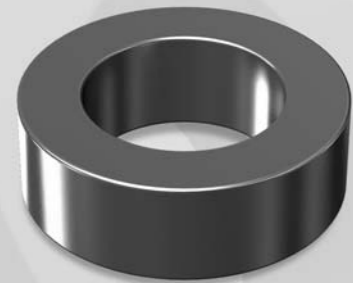

ID 23.37mm
HT 8.89mm

Core Dimensions

		OD(max)	ID(min)	HT(max)
Before coating	(mm)	34.29	23.37	8.89
	(inch)	1.350	0.920	0.350
After coating (Epoxy)	(mm)	35.20	22.60	9.83
	(inch)	1.385	0.888	0.387

Magnetic Dimensions

Cross Section (A)	Path Length (l)	Window Area (Wa)	Volume (V)
0.454cm ²	8.95cm	4.01cm ²	4.0633cm ³
0.0704in ²	3.53in	788,500cmil	0.2485in ³

Available Cores

MPP	Part No.				AL (nH/N ²)	Perm. (μ)
	High Flux	Sendust	Mega Flux [®]			
CM343026	CH343026	CS343026	CK343026		16	26
CM343060	CH343060	CS343060	CK343060		38	60
-	-	CS343075	CK343075		47	75
-	-	CS343090	CK343090		57	90
CM343125	CH343125	CS343125	-		79	125
CM343147	CH343147	-	-		93	147
CM343160	CH343160	-	-		101	160
CM343173	-	-	-		109	173
-	-	-	-		126	200

Winding Information

AWG Wire No.	Dia(cm)	Single Layer		AWG Wire No.	Dia(cm)	Single Layer	
		Turn	Rdc, Ω			Turn	Rdc, Ω
12	0.213	27	0.00533	21	0.0785	77	0.105
13	0.190	30	0.00740	22	0.0701	87	0.148
14	0.171	34	0.0102	23	0.0632	96	0.206
15	0.153	38	0.0143	24	0.0566	108	0.288
16	0.137	43	0.0199	25	0.0505	121	0.404
17	0.122	49	0.0277	26	0.0452	135	0.569
18	0.109	55	0.0388	27	0.0409	150	0.789
19	0.0980	61	0.0541	28	0.0366	168	1.11
20	0.0879	69	0.0754	29	0.0330	186	1.53

Single layer winding with 1 inch leads

AL vs NI Curve (60μ, 125μ)

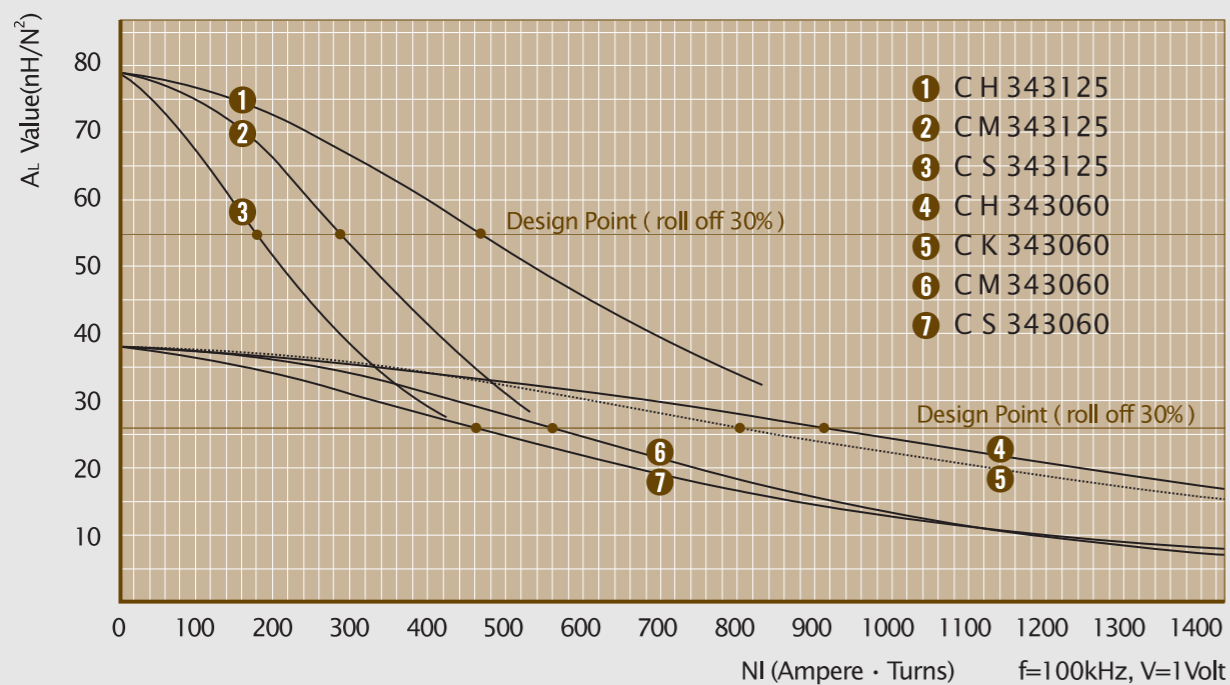

OD358

OD 35.81 mm / 1.410inches

ID 22.35mm
HT 10.46mm

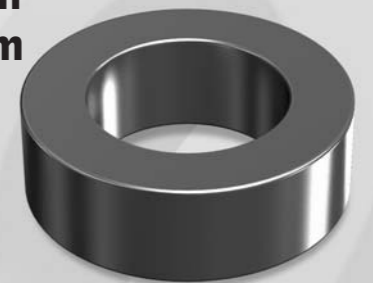

Core Dimensions

		OD(max)	ID(min)	HT(max)
Before coating	(mm)	35.81	22.35	10.46
	(inch)	1.410	0.880	0.412
After coating (Epoxy)	(mm)	36.70	21.50	11.28
	(inch)	1.445	0.848	0.444

Magnetic Dimensions

Cross Section (A)	Path Length (l)	Window Area (Wa)	Volume (V)
0.678cm ²	8.98cm	3.64cm ²	6.0884cm ³
0.1051in ²	3.54in	719,100cmil	0.3721in ³

Winding Information

AWG Wire No.	Dia(cm)	Single Layer		AWG Wire No.	Dia(cm)	Single Layer	
		Turn	Rdc, Ω			Turn	Rdc, Ω
12	0.213	25	0.00579	21	0.0785	74	0.117
13	0.190	29	0.00809	22	0.0701	82	0.166
14	0.171	32	0.0112	23	0.0632	92	0.229
15	0.153	37	0.0157	24	0.0566	103	0.322
16	0.137	41	0.0220	25	0.0505	115	0.452
17	0.122	46	0.0306	26	0.0452	129	0.637
18	0.109	52	0.0429	27	0.0409	143	0.885
19	0.0980	58	0.0600	28	0.0366	160	1.25
20	0.0879	65	0.0837	29	0.0330	177	1.71

Single layer winding with 1 inch leads

Available Cores

MPP	Part No.				AL (nH/N ²)	Perm. (μ)
	High Flux	Sendust	Mega Flux [®]			
CM358026	CH358026	CS358026	CK358026		24	26
CM358060	CH358060	CS358060	CK358060		56	60
-	-	CS358075	CK358075		70	75
-	-	CS358090	CK358090		84	90
CM358125	CH358125	CS358125	-		117	125
CM358147	CH358147	-	-		138	147
CM358160	CH358160	-	-		150	160
CM358173	-	-	-		162	173
-	-	-	-		187	200

AL vs NI Curve (60μ, 125μ)

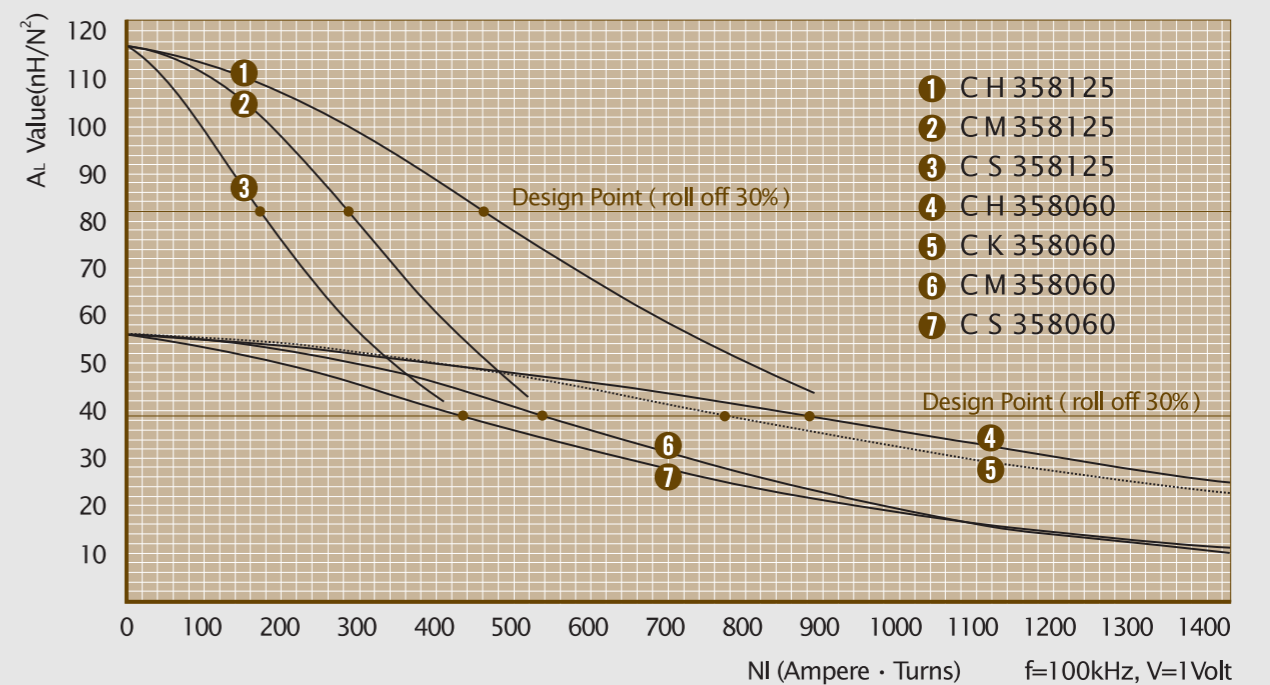

OD400

OD 39.88mm / 1.570inches



ID 24.13mm
HT 14.48mm

Core Dimensions

		OD(max)	ID(min)	HT(max)
Before coating	(mm)	39.88	24.13	14.48
	(inch)	1.570	0.950	0.570
After coating (Epoxy)	(mm)	40.70	23.30	15.37
	(inch)	1.602	0.918	0.605

Magnetic Dimensions

Cross Section (A)	Path Length (l)	Window Area (Wa)	Volume (V)
1.072cm ²	9.84cm	4.27cm ²	10.5485cm ³
0.1662in ²	3.88in	842,700cmil	0.6449in ³

Available Cores

MPP	Part No.				AL (nH/N ²)	Perm. (μ)
	High Flux	Sendust	Mega Flux [®]			
CM400026	CH400026	CS400026	CK400026		35	26
CM400060	CH400060	CS400060	CK400060		81	60
-	-	CS400075	CK400075		101	75
-	-	CS400090	CK400090		121	90
CM400125	CH400125	CS400125	-		168	125
CM400147	CH400147	-	-		198	147
CM400160	CH400160	-	-		215	160
CM400173	-	-	-		233	173
-	-	-	-		269	200

Winding Information

AWG Wire No.	Single Layer Dia(cm)	Turn	Rdc, Ω	AWG Wire No.	Single Layer Dia(cm)	Turn	Rdc, Ω
10	0.213	22	0.00389	19	0.0785	64	0.0804
11	0.190	25	0.00545	20	0.0701	71	0.112
12	0.171	28	0.00762	21	0.0632	80	0.158
13	0.153	31	0.0107	22	0.0566	90	0.223
14	0.137	35	0.0148	23	0.0505	100	0.309
15	0.122	40	0.0208	24	0.0452	112	0.435
16	0.109	45	0.0292	25	0.0409	125	0.611
17	0.0980	50	0.0408	26	0.0366	140	0.862
18	0.0879	57	0.0574	27	0.0330	155	1.20

Single layer winding with 1 inch leads

AL vs NI Curve (60μ, 125μ)

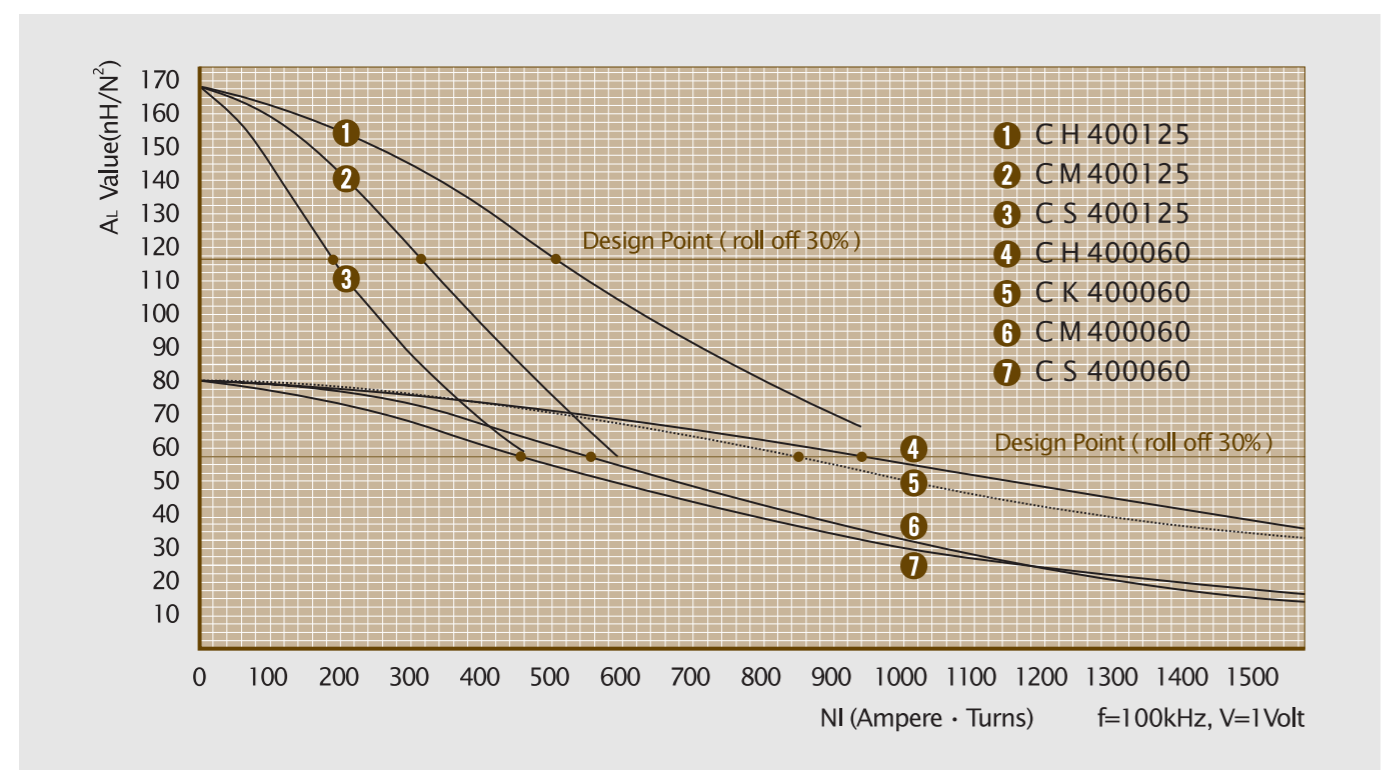

OD467

OD 46.74mm / 1.840inches



ID 24.13mm
HT 18.03mm

Core Dimensions

		OD(max)	ID(min)	HT(max)
Before coating	(mm)	46.74	24.13	18.03
	(inch)	1.840	0.950	0.710
After coating (Epoxy)	(mm)	47.60	23.30	18.92
	(inch)	1.875	0.918	0.745

Magnetic Dimensions

Cross Section (A)	Path Length (l)	Window Area (Wa)	Volume (V)
1.990cm ²	10.74cm	4.27cm ²	21.373cm ³
0.308in ²	4.23in	842,700cmil	1.303in ³

Winding Information

AWG Wire No.	Single Layer Dia(cm)	Turn	Rdc, Ω	AWG Wire No.	Single Layer Dia(cm)	Turn	Rdc, Ω
10	0.213	22	0.0488	19	0.0785	64	0.104
11	0.190	25	0.0688	20	0.0701	71	0.146
12	0.171	28	0.0966	21	0.0632	80	0.205
13	0.153	31	0.0136	22	0.0566	90	0.290
14	0.137	35	0.0189	23	0.0505	100	0.403
15	0.122	40	0.0267	24	0.0452	112	0.567
16	0.109	45	0.0375	25	0.0409	125	0.798
17	0.0980	50	0.0526	26	0.0366	140	1.13
18	0.0879	57	0.0740	27	0.0330	155	1.57

Single layer winding with 1 inch leads

Available Cores

MPP	Part No.				AL (nH/N ²)	Perm. (μ)
	High Flux	Sendust	Mega Flux [®]			
CM467026	CH467026	CS467026	CK467026		59	26
CM467060	CH467060	CS467060	CK467060		135	60
-	-	CS467075	CK467075		169	75
-	-	CS467090	CK467090		202	90
CM467125	CH467125	CS467125	-		281	125
CM467147	-	-	-		330	147
CM467160	-	-	-		360	160
-	-	-	-		-	173
-	-	-	-		-	200

AL vs NI Curve (60μ, 125μ)

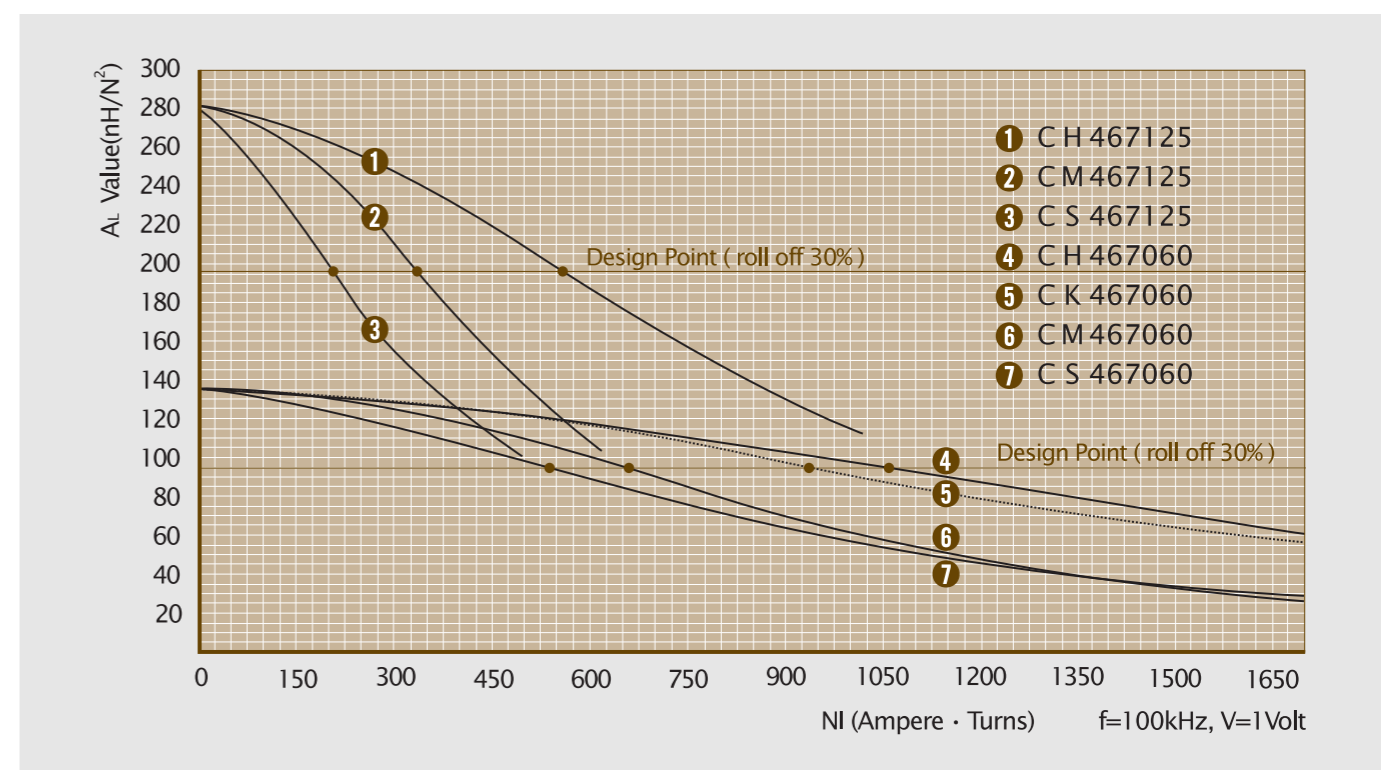

OD468

OD 46.74mm / 1.840inches



ID 28.70mm
HT 15.24mm

Core Dimensions

		OD(max)	ID(min)	HT(max)
Before coating	(mm)	46.74	28.70	15.24
	(inch)	1.840	1.130	0.600
After coating (Epoxy)	(mm)	47.60	27.90	16.13
	(inch)	1.875	1.098	0.635

Magnetic Dimensions

Cross Section (A)	Path Length (l)	Window Area (Wa)	Volume (V)
1.340cm ²	11.63cm	6.11cm ²	15.584cm ³
0.208in ²	4.58in	1,206,000cmil	0.9526in ³

Available Cores

MPP	Part No.				AL (nH/N ²)	Perm. (μ)
	High Flux	Sendust	Mega Flux [®]			
CM468026	CH468026	CS468026	CK468026		37	26
CM468060	CH468060	CS468060	CK468060		86	60
-	-	CS468075	CK468075		107	75
-	-	CS468090	CK468090		128	90
CM468125	CH468125	CS468125	-		178	125
CM468147	-	-	-		210	147
CM468160	-	-	-		228	160
-	-	-	-		-	173
-	-	-	-		-	200

Winding Information

AWG Wire No.	Single Layer Dia(cm)	Turn	Rdc, Ω	AWG Wire No.	Single Layer Dia(cm)	Turn	Rdc, Ω
10	0.267	26	0.00505	19	0.0980	77	0.104
11	0.238	30	0.00708	20	0.0879	86	0.146
12	0.213	34	0.0099	21	0.0785	96	0.205
13	0.190	38	0.0139	22	0.0701	108	0.290
14	0.171	43	0.0193	23	0.0632	120	0.402
15	0.153	48	0.0270	24	0.0566	134	0.565
16	0.137	54	0.0380	25	0.0505	150	0.795
17	0.122	61	0.0530	26	0.0452	168	1.12
18	0.109	68	0.0745	27	0.0409	186	1.56

Single layer winding with 1 inch leads

AL vs NI Curve (60μ, 125μ)

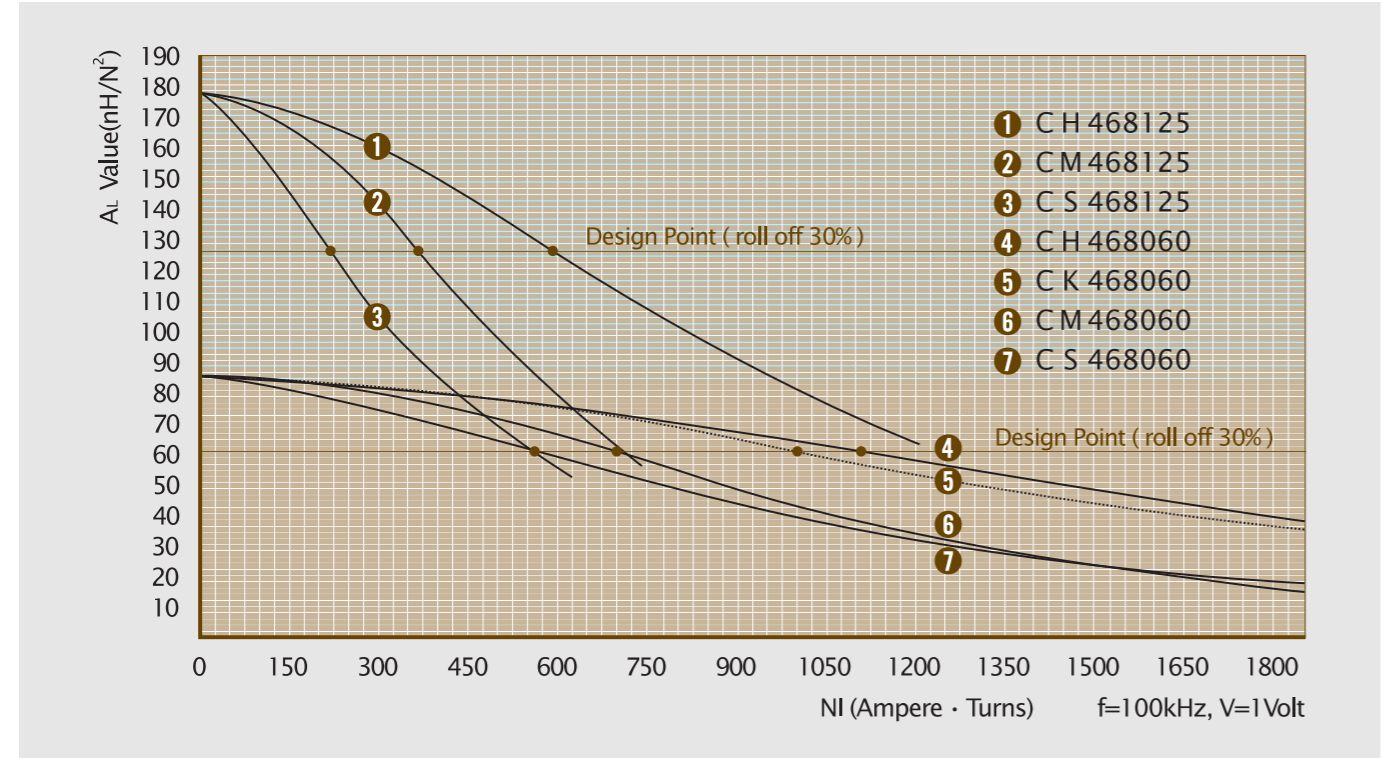

OD508

OD 50.80mm / 2.000inches



ID 31.75mm
HT 13.46mm

Core Dimensions

		OD(max)	ID(min)	HT(max)
Before coating	(mm)	50.80	31.75	13.46
	(inch)	2.000	1.250	0.530
After coating (Epoxy)	(mm)	51.70	30.90	14.35
	(inch)	2.035	1.218	0.565

Magnetic Dimensions

Cross Section (A)	Path Length (l)	Window Area (Wa)	Volume (V)
1.251cm ²	12.73cm	7.50cm ²	15.929cm ³
0.194in ²	5.02in	1,484,000cmil	0.9739in ³

Winding Information

AWG Wire No.	Single Layer Dia(cm)	Turn	Rdc, Ω	AWG Wire No.	Single Layer Dia(cm)	Turn	Rdc, Ω
10	0.267	30	0.00539	19	0.0980	85	0.110
11	0.238	33	0.00754	20	0.0879	95	0.154
12	0.213	38	0.0105	21	0.0785	107	0.216
13	0.190	43	0.0147	22	0.0701	120	0.306
14	0.171	48	0.0205	23	0.0632	133	0.424
15	0.153	54	0.0287	24	0.0566	149	0.596
16	0.137	60	0.0402	25	0.0505	167	0.838
17	0.122	68	0.0562	26	0.0452	186	1.18
18	0.109	76	0.0788	27	0.0409	207	1.64

Single layer winding with 1 inch leads

Available Cores

MPP	Part No.				AL (nH/N ²)	Perm. (μ)
	High Flux	Sendust	Mega Flux [®]			
CM508026	CH508026	CS508026	CK508026		32	26
CM508060	CH508060	CS508060	CK508060		73	60
-	-	CS508075	CK508075		91	75
-	-	CS508090	CK508090		109	90
CM508125	CH508125	CS508125	-		152	125
CM508147	-	-	-		179	147
CM508160	-	-	-		195	160
-	-	-	-		-	173
-	-	-	-		-	200

AL vs NI Curve (60μ, 125μ)

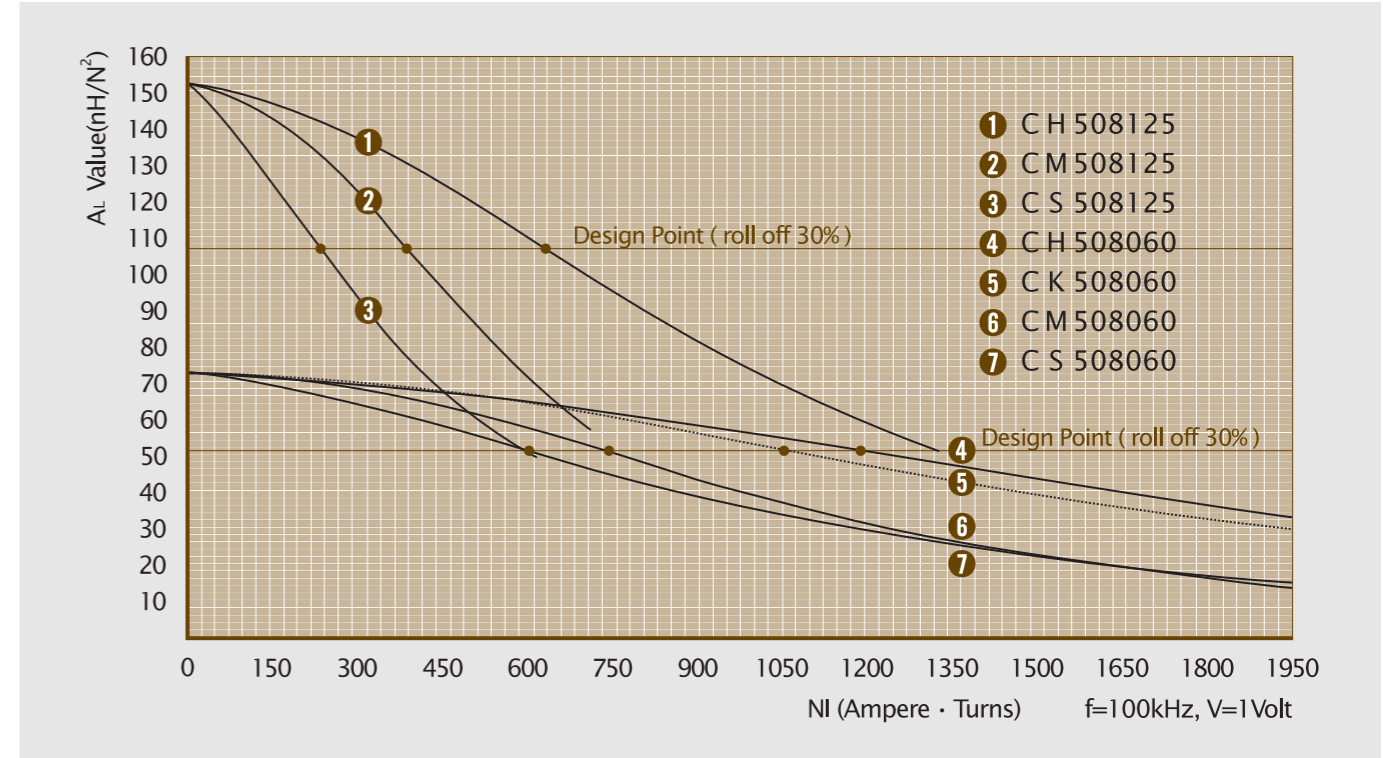

OD571

OD 57.15mm / 2.250inches



ID 26.39mm
HT 15.24mm

Core Dimensions

		OD(max)	ID(min)	HT(max)
Before coating	(mm)	57.15	26.39	15.24
	(inch)	2.250	1.039	0.600
After coating (Epoxy)	(mm)	58.00	25.60	16.10
	(inch)	2.285	1.007	0.635

Magnetic Dimensions

Cross Section (A)	Path Length (l)	Window Area (Wa)	Volume (V)
2.29cm ²	12.5cm	5.14cm ²	28.6cm ³
0.355in ²	4.93in	1,014,049cmil	1.75in ³

Available Cores

Part No.				AL	Perm.
MPP	High Flux	Sendust	Mega Flux®	(nH/N ²)	(μ)
CM571026	CH571026	CS571026	CK571026	60	26
CM571060	CH571060	CS571060	CK571060	138	60
-	-	CS571075	CK571075	172	75
-	-	CS571090	CK571090	206	90
CM571125	CH571125	CS571125	-	287	125
CM571147	-	-	-	306	147
CM571160	-	-	-	333	160
-	-	-	-	-	173
-	-	-	-	-	200

Winding Information

AWG Wire No.	Single Layer Dia(cm)	Turn	Rdc, Ω	AWG Wire No.	Single Layer Dia(cm)	Turn	Rdc, Ω
10	0.267	26	0.00551	19	0.0980	78	0.133
11	0.238	30	0.00801	20	0.0879	88	0.189
12	0.213	34	0.0115	21	0.0785	99	0.269
13	0.190	39	0.0165	22	0.0701	111	0.381
14	0.171	43	0.0230	23	0.0632	124	0.534
15	0.153	49	0.0330	24	0.0566	138	0.752
16	0.137	55	0.0469	25	0.0505	156	1.07
17	0.122	62	0.0664	26	0.0452	174	1.51
18	0.109	70	0.0948	27	0.0409	193	2.10

Single layer winding with 1 inch leads

AL vs NI Curve (60μ, 125μ)

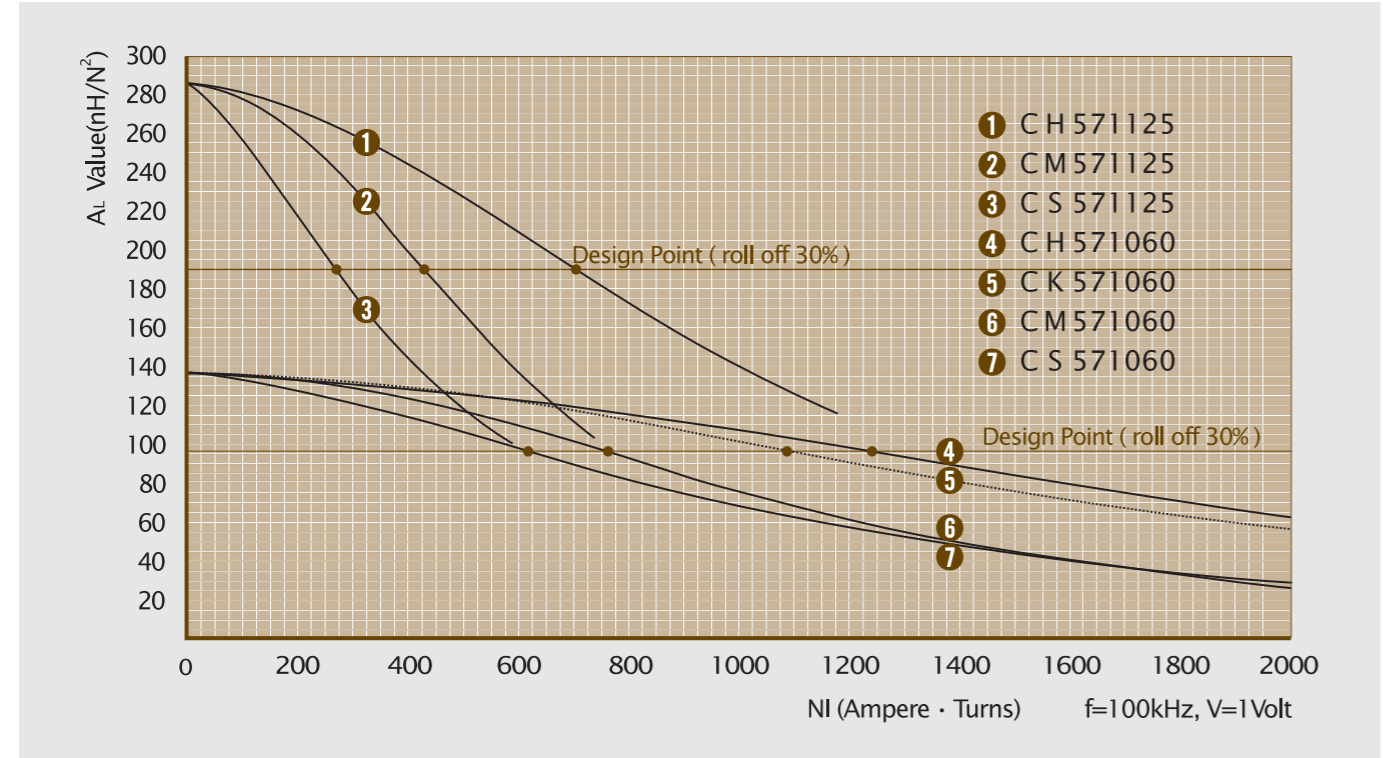

OD572

OD 57.15mm / 2.250inches



ID 35.56mm
HT 13.97mm

Core Dimensions

		OD(max)	ID(min)	HT(max)
Before coating	(mm)	57.15	35.56	13.97
	(inch)	2.250	1.400	0.550
After coating (Epoxy)	(mm)	58.00	34.70	14.86
	(inch)	2.285	1.368	0.585

Magnetic Dimensions

Cross Section (A)	Path Length (l)	Window Area (Wa)	Volume (V)
1.444cm ²	14.30cm	9.48cm ²	20.65cm ³
0.244in ²	5.63in	1,871,000cmil	1.261in ³

Winding Information

AWG Wire No.	Single Layer Dia(cm)	Turn	Rdc, Ω	AWG Wire No.	Single Layer Dia(cm)	Turn	Rdc, Ω
10	0.267	37	0.00644	19	0.0980	108	0.152
11	0.238	42	0.00920	20	0.0879	120	0.211
12	0.213	48	0.0133	21	0.0785	135	0.300
13	0.190	54	0.0188	22	0.0701	152	0.428
14	0.171	60	0.0263	23	0.0632	169	0.596
15	0.153	68	0.0376	24	0.0566	189	0.845
16	0.137	76	0.0531	25	0.0505	212	1.19
17	0.122	85	0.0746	26	0.0452	237	1.69
18	0.109	96	0.107	27	0.0409	263	2.35

Single layer winding with 1 inch leads

Available Cores

Part No.				AL	Perm.
MPP	High Flux	Sendust	Mega Flux®	(nH/N ²)	(μ)
CM572026	CH572026	CS572026	CK572026	33	26
CM572060	CH572060	CS572060	CK572060	75	60
-	-	CS572075	CK572075	94	75
-	-	CS572090	CK572090	112	90
CM572125	CH572125	CS572125	-	156	125
CM572147	-	-	-	185	147
CM572160	-	-	-	200	160
-	-	-	-	-	173
-	-	-	-	-	200

AL vs NI Curve (60μ, 125μ)

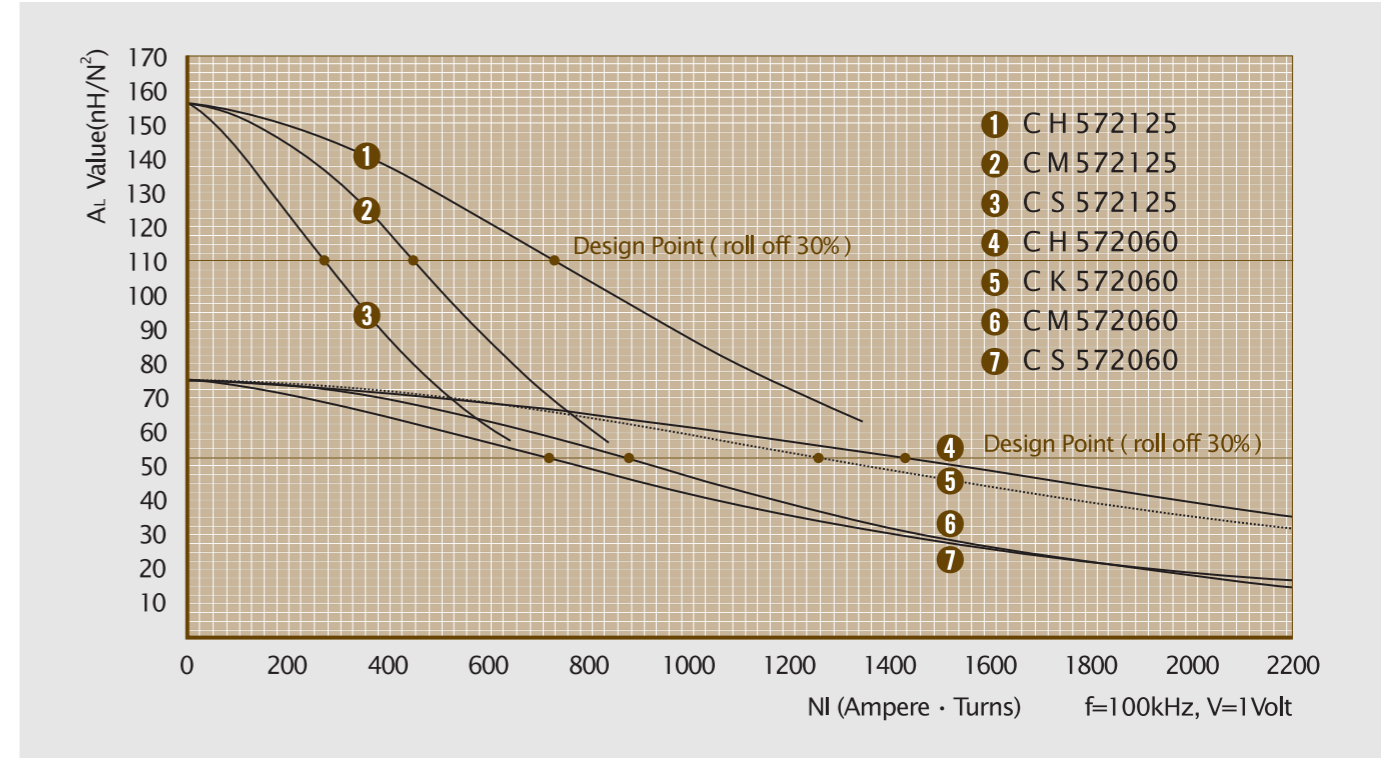

OD610

OD 62.0mm / 2.441 inches

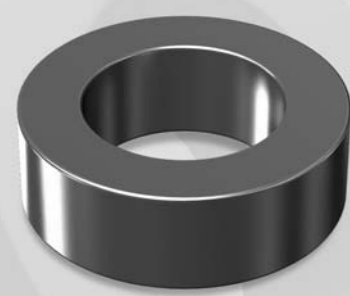

ID 32.6mm
HT 25.0mm

Core Dimensions

		OD(max)	ID(min)	HT(max)
Before coating	(mm)	62.0	32.6	25.0
	(inch)	2.441	1.283	0.984
After coating (Epoxy)	(mm)	63.1	31.37	26.27
	(inch)	2.484	1.235	1.034

Magnetic Dimensions

Cross Section (A)	Path Length (l)	Window Area (Wa)	Volume (V)
3.675cm ²	14.37cm	7.73cm ²	52.81cm ³
0.570in ²	5.66in	1,525,610cmil	3.223in ³

Available Cores

Part No.				AL	Perm.
MPP	High Flux	Sendust	Mega Flux®	(nH/N ²)	(μ)
CM610026	CH610026	CS610026	CK610026	83	26
CM610060	CH610060	CS610060	CK610060	192	60
-	-	CS610075	CK610075	240	75
-	-	CS610090	CK610090	288	90
CM610125	CH610125	CS610125	-	400	125
-	-	-	-	-	147
-	-	-	-	-	160
-	-	-	-	-	173
-	-	-	-	-	200

Winding Information

AWG Wire No.	Single Layer Dia(cm)	Turn Rdc, Q	AWG Wire No.	Single Layer Dia(cm)	Turn Rdc, Q
10	0.267		19	0.0980	
11	0.238		20	0.0879	
12	0.213		21	0.0785	
13	0.190		22	0.0701	
14	0.171	N · A	23	0.0632	N · A
15	0.153		24	0.0566	
16	0.137		25	0.0505	
17	0.122		26	0.0452	
18	0.109		27	0.0409	

Single layer winding with 1 inch leads

AL vs NI Curve (60μ, 125μ)

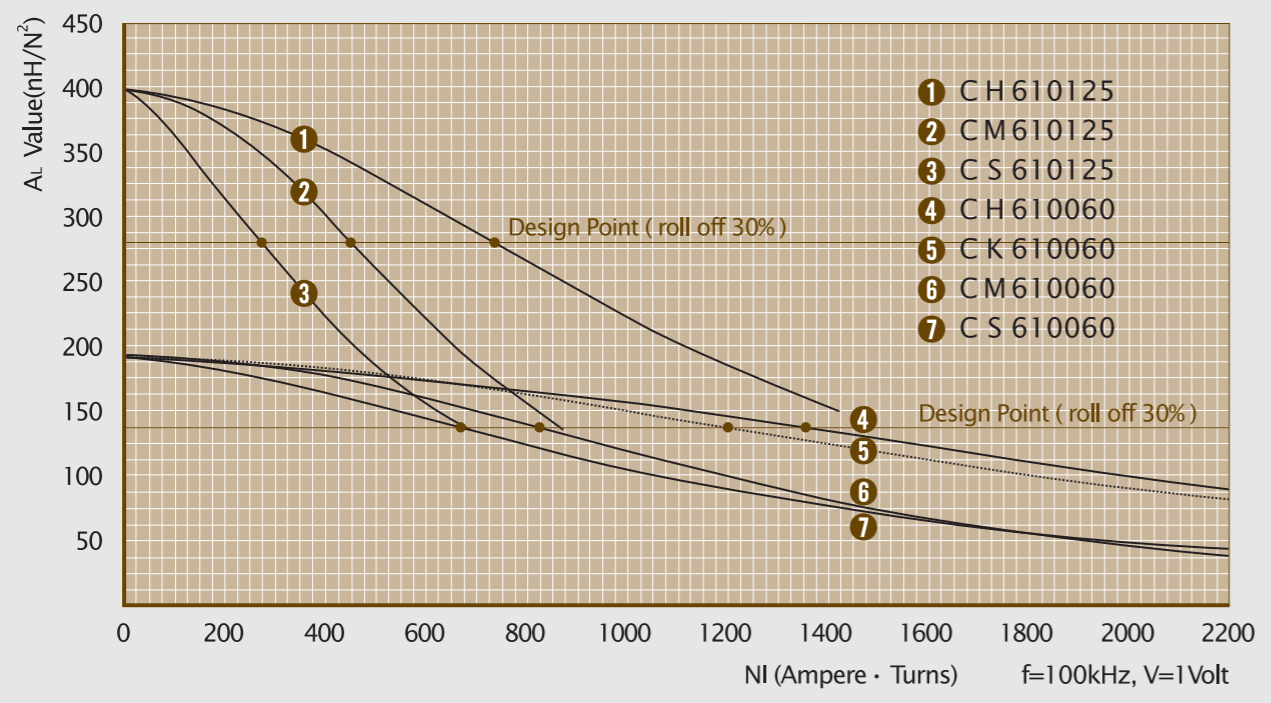

OD740

OD 74.1mm / 2.917 inches



ID 45.3mm
HT 35.0mm

Core Dimensions

		OD(max)	ID(min)	HT(max)
Before coating	(mm)	74.1	45.3	35.0
	(inch)	2.917	1.783	1.378
After coating (Epoxy)	(mm)	75.2	44.07	36.27
	(inch)	2.961	1.735	1.428

Magnetic Dimensions

Cross Section (A)	Path Length (l)	Window Area (Wa)	Volume (V)
5.040cm ²	18.38cm	15.25cm ²	92.64cm ³
0.781in ²	7.24in	3,009,310cmil	5.653in ³

Winding Information

AWG Wire No.	Single Layer Dia(cm)	Turn Rdc, Q	AWG Wire No.	Single Layer Dia(cm)	Turn Rdc, Q
10	0.267		19	0.0980	
11	0.238		20	0.0879	
12	0.213		21	0.0785	
13	0.190		22	0.0701	
14	0.171	N · A	23	0.0632	N · A
15	0.153		24	0.0566	
16	0.137		25	0.0505	
17	0.122		26	0.0452	
18	0.109		27	0.0409	

Single layer winding with 1 inch leads

Available Cores

Part No.				AL	Perm.
MPP	High Flux	Sendust	Mega Flux®	(nH/N ²)	(μ)
CM740026	CH740026	CS740026	CK740026	89	26
CM740060	CH740060	CS740060	CK740060	206	60
-	-	CS740075	CK740075	257	75
-	-	CS740090	CK740090	309	90
CM740125	CH740125	CS740125	-	429	125
-	-	-	-	-	147
-	-	-	-	-	160
-	-	-	-	-	173
-	-	-	-	-	200

AL vs NI Curve (60μ, 125μ)

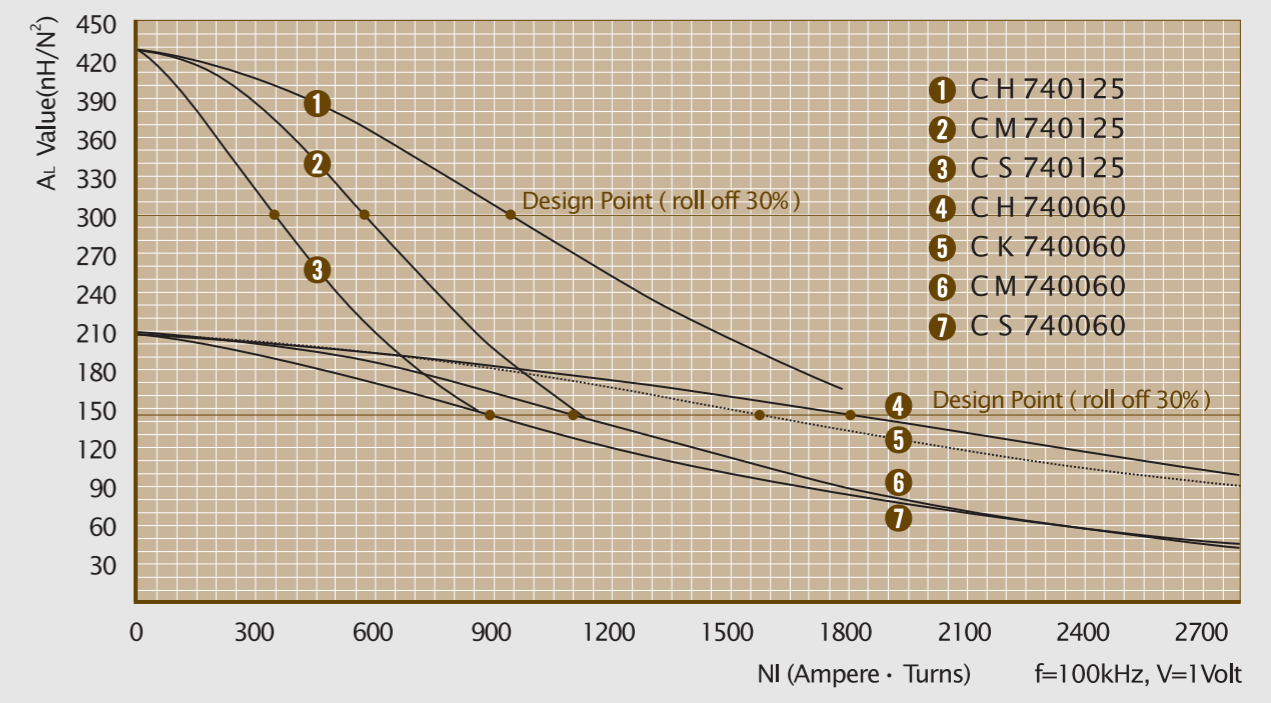

OD 777

OD 77.8mm / 3.063inches

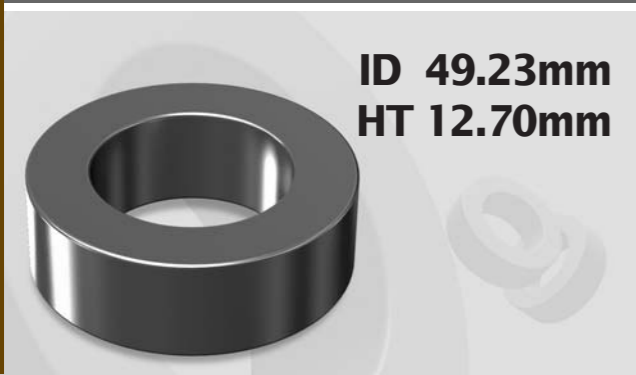

ID 49.23mm
HT 12.70mm

Core Dimensions

		OD(max)	ID(min)	HT(max)
Before coating	(mm)	77.80	49.23	12.70
	(inch)	3.063	1.938	0.50
After coating (Epoxy)	(mm)	78.90	48.0	13.97
	(inch)	3.108	1.888	0.550

Magnetic Dimensions

Cross Section (A)	Path Length (l)	Window Area (Wa)	Volume (V)
1.770cm ²	20.0cm	17.99cm ²	34.770cm ³
0.274in ²	7.72in	3,550,000cmil	2.122in ³

Available Cores

MPP	Part No.				AL	Perm.
	High Flux	Sendust	Mega Flux®	(nH/N ²)		
CM777026	CH777026	CS777026	CK777026	30	26	
CM777060	CH777060	CS777060	CK777060	68	60	
-	-	CS777075	CK777075	85	75	
-	-	CS777090	CK777090	102	90	
CM777125	CH777125	CS777125	-	142	125	
-	-	-	-	-	147	
-	-	-	-	-	160	
-	-	-	-	-	173	
-	-	-	-	-	200	

Winding Information

AWG Wire No.	Single Layer Dia(cm)	Turn	Rdc, Ω	AWG Wire No.	Single Layer Dia(cm)	Turn	Rdc, Ω
10	0.267	53	0.0113	19	0.0980	150	0.258
11	0.238	60	0.0162	20	0.0879	168	0.364
12	0.213	67	0.0228	21	0.0785	188	0.514
13	0.190	76	0.0325	22	0.0701	211	0.732
14	0.171	84	0.0454	23	0.0632	235	1.02
15	0.153	95	0.0646	24	0.0566	263	1.30
16	0.137	106	0.0912	25	0.0505	295	1.84
17	0.122	119	0.129	26	0.0452	330	2.61
18	0.109	134	0.183	27	0.0409	365	3.62

Single layer winding with 1 inch leads

AL vs NI Curve (60μ, 125μ)

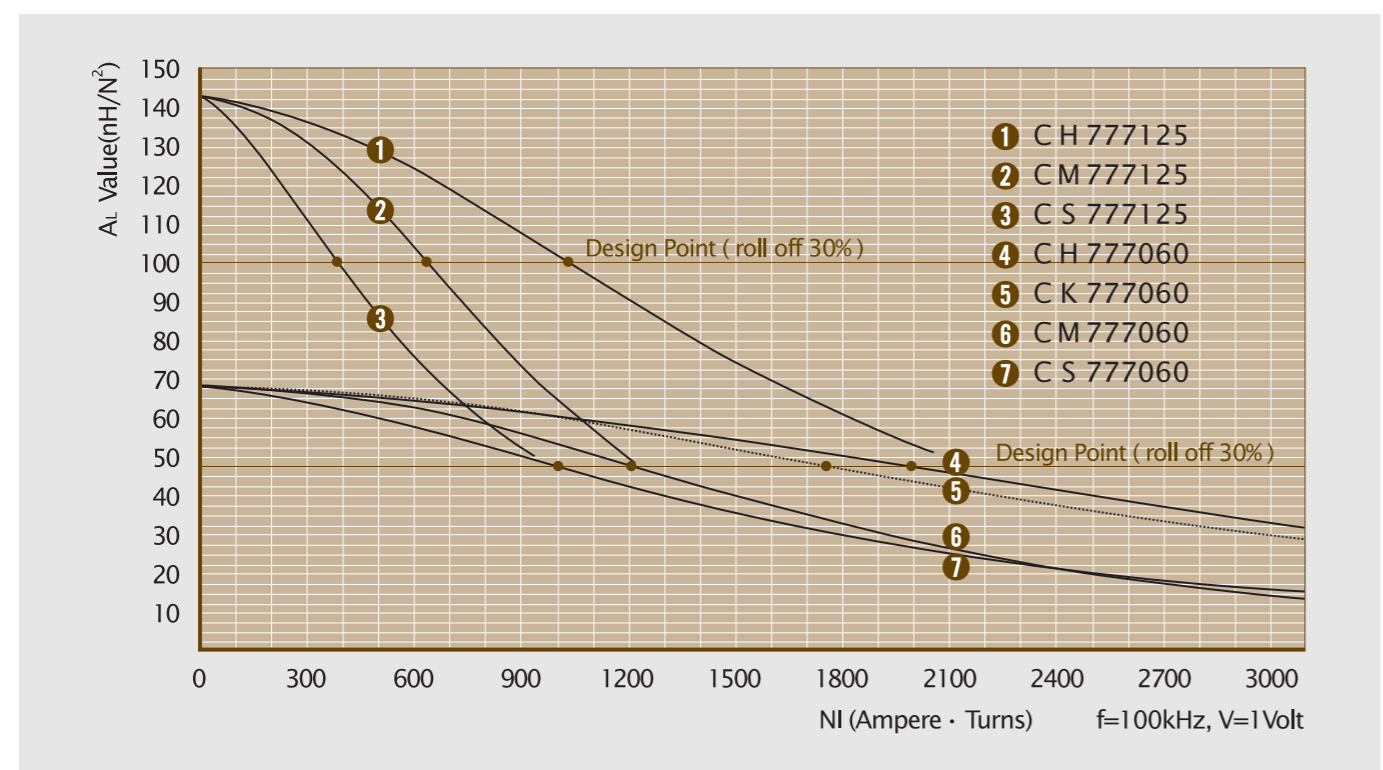

- 1 CH 777125
- 2 CM 777125
- 3 CS 777125
- 4 CH 777060
- 5 CK 777060
- 6 CM 777060
- 7 CS 777060

OD 778

OD 77.8mm / 3.063inches



ID 49.23mm
HT 15.9mm

Core Dimensions

		OD(max)	ID(min)	HT(max)
Before coating	(mm)	77.80	49.23	15.9
	(inch)	3.063	1.938	0.626
After coating (Epoxy)	(mm)	78.90	48.0	17.2
	(inch)	3.108	1.888	0.677

Magnetic Dimensions

Cross Section (A)	Path Length (l)	Window Area (Wa)	Volume (V)
2.270cm ²	20.0cm	17.99cm ²	43.531cm ³
0.352in ²	7.72in	3,550,000cmil	2.656in ³

Winding Information

AWG Wire No.	Single Layer Dia(cm)	Turn	Rdc, Ω	AWG Wire No.	Single Layer Dia(cm)	Turn	Rdc, Ω
10	0.267			19	0.0980		
11	0.238			20	0.0879		
12	0.213			21	0.0785		
13	0.190			22	0.0701		
14	0.171	N · A		23	0.0632	N · A	
15	0.153			24	0.0566		
16	0.137			25	0.0505		
17	0.122			26	0.0452		
18	0.109			27	0.0409		

Single layer winding with 1 inch leads

Available Cores

MPP	Part No.				AL	Perm.
	High Flux	Sendust	Mega Flux®	(nH/N ²)		
CM778026	CH778026	CS778026	CK778026	37	26	
CM778060	CH778060	CS778060	CK778060	85	60	
-	-	CS778075	CK778075	107	75	
-	-	CS778090	CK778090	128	90	
CM778125	CH778125	CS778125	-	178	125	
-	-	-	-	-	147	
-	-	-	-	-	160	
-	-	-	-	-	173	
-	-	-	-	-	200	

AL vs NI Curve (60μ, 125μ)

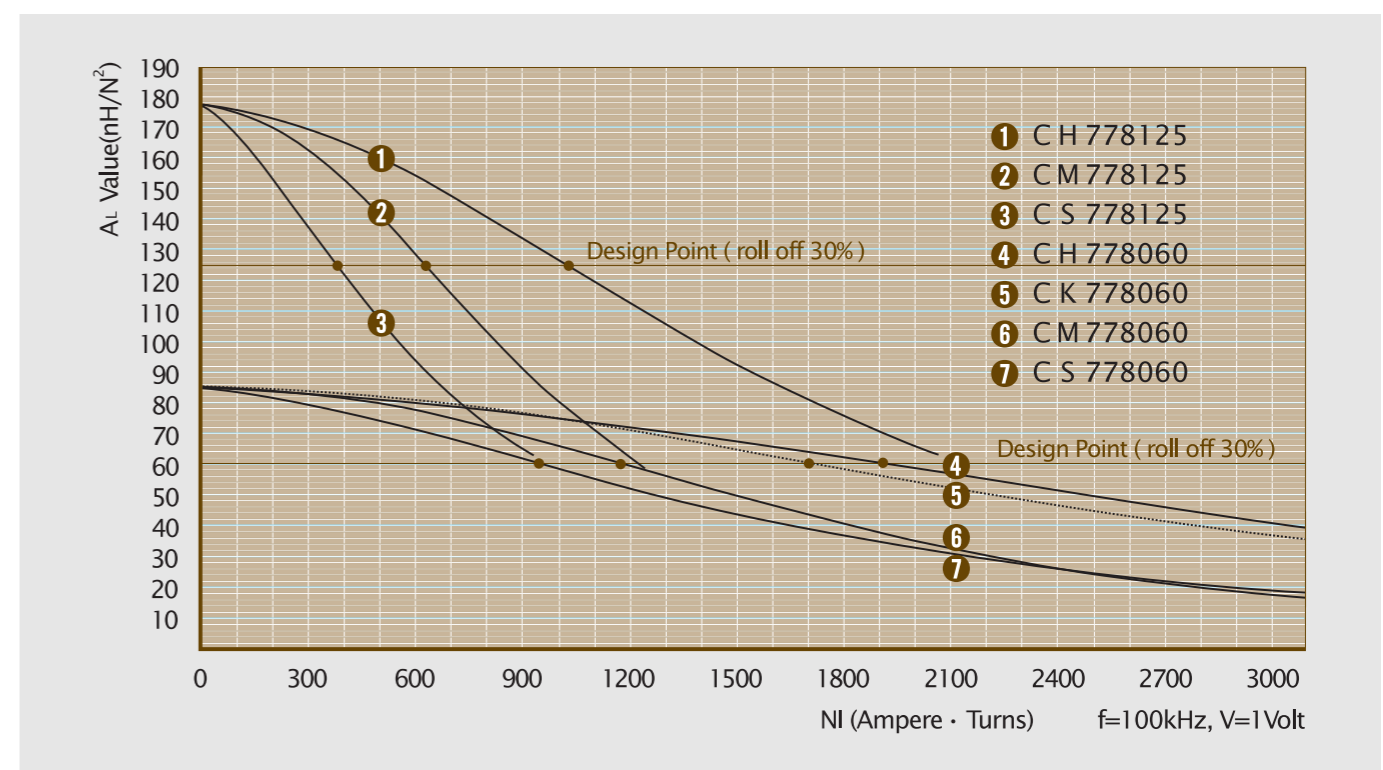

- 1 CH 778125
- 2 CM 778125
- 3 CS 778125
- 4 CH 778060
- 5 CK 778060
- 6 CM 778060
- 7 CS 778060

OD888

OD 88.9mm / 3.500inches

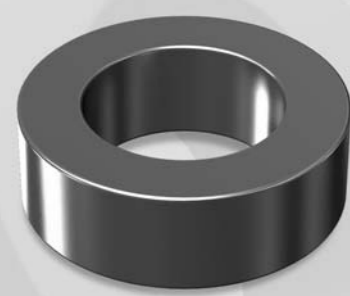

ID 66.0mm
HT 15.9mm

Core Dimensions

		OD(max)	ID(min)	HT(max)
Before coating	(mm)	88.90	66.00	15.90
	(inch)	3.500	2.598	0.626
After coating (Epoxy)	(mm)	90.03	64.74	17.20
	(inch)	3.544	2.549	0.677

Magnetic Dimensions

Cross Section (A)	Path Length (l)	Window Area (Wa)	Volume (V)
1.83cm ²	24.10cm	32.92cm ²	44,103cm ³
0.284in ²	9.46in	6,00,140cmil	2.691in ³

Available Cores

Part No.				A _L	Perm.
MPP	High Flux	Sendust	Mega Flux®	(nH/N ²)	(μ)
CM888026	CH888026	CS888026	CK888026	24	26
CM888060	CH888060	CS888060	CK888060	57	60
-	-	CS888075	CK888075	71	75
-	-	CS888090	CK888090	85	90
CM888125	CH888125	CS888125	-	119	125
-	-	-	-	-	147
-	-	-	-	-	160
-	-	-	-	-	173
-	-	-	-	-	200

Winding Information

AWG Wire No.	Single Layer Dia(cm)	Turn Rdc, Q	AWG Wire No.	Single Layer Dia(cm)	Turn Rdc, Q
10	0.267		19	0.0980	
11	0.238		20	0.0879	
12	0.213		21	0.0785	
13	0.190		22	0.0701	
14	0.171	N · A	23	0.0632	N · A
15	0.153		24	0.0566	
16	0.137		25	0.0505	
17	0.122		26	0.0452	
18	0.109		27	0.0409	

Single layer winding with 1 inch leads

■ A_L vs NI Curve (60μ, 125μ)

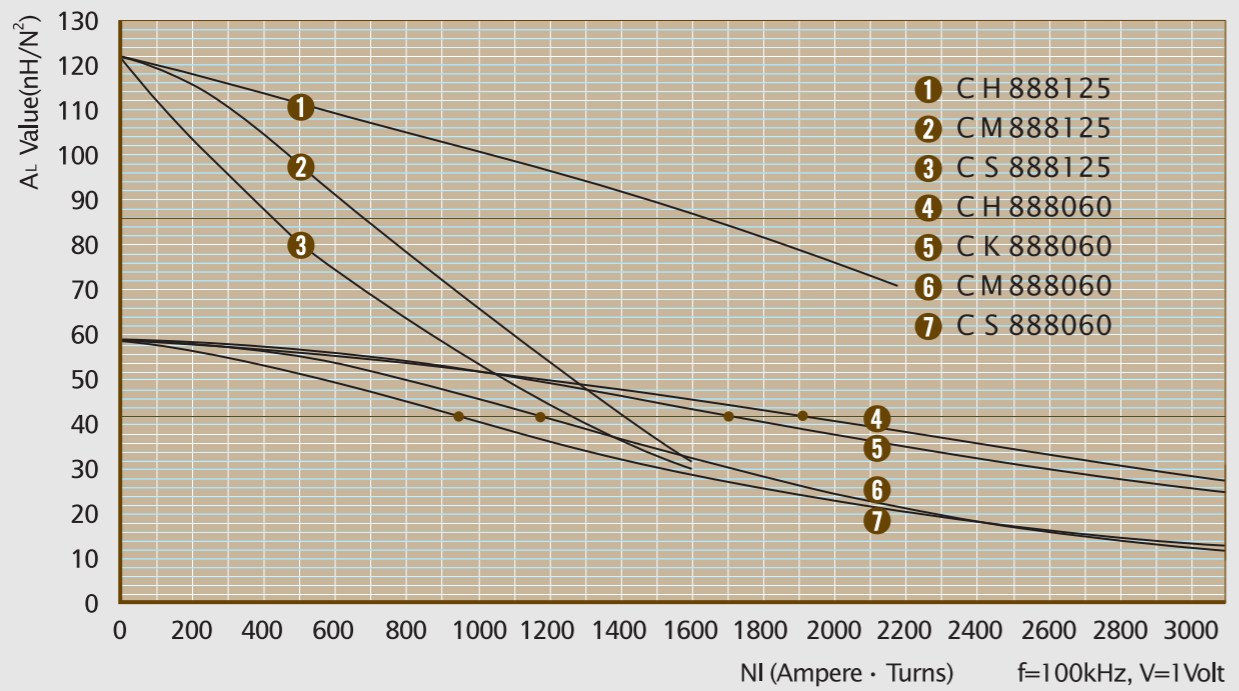

OD1016

OD 101.6mm / 3.980inches

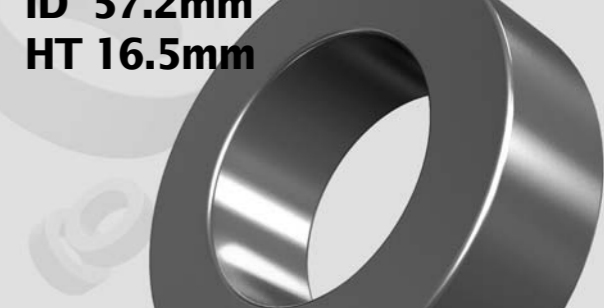

ID 57.2mm
HT 16.5mm

Core Dimensions

		OD(max)	ID(min)	HT(max)
Before coating	(mm)	101.6	57.2	16.5
	(inch)	3.980	2.252	0.650
After coating (Epoxy)	(mm)	103.1	55.7	17.8
	(inch)	4.059	2.193	0.701

Magnetic Dimensions

Cross Section (A)	Path Length (l)	Window Area (Wa)	Volume (V)
3.522cm ²	24.27cm	24.36cm ²	85.495cm ³
0.546in ²	9.56in	4,807,425cmil	5.217in ³

Winding Information

AWG Wire No.	Single Layer Dia(cm)	Turn Rdc, Q	AWG Wire No.	Single Layer Dia(cm)	Turn Rdc, Q
10	0.267		19	0.0980	
11	0.238		20	0.0879	
12	0.213		21	0.0785	
13	0.190		22	0.0701	
14	0.171	N · A	23	0.0632	N · A
15	0.153		24	0.0566	
16	0.137		25	0.0505	
17	0.122		26	0.0452	
18	0.109		27	0.0409	

Single layer winding with 1 inch leads

Available Cores

Part No.				A _L	Perm.
MPP	High Flux	Sendust	Mega Flux®	(nH/N ²)	(μ)
CM1016026	CH1016026	CS1016026	CK1016026	48	26
CM1016060	CH1016060	CS1016060	CK1016060	112	60
CM1016125	CH1016125	CS1016125	-	228	125
-	-	-	-	-	147
-	-	-	-	-	160
-	-	-	-	-	173
-	-	-	-	-	200

■ A_L vs NI Curve (60μ, 125μ)

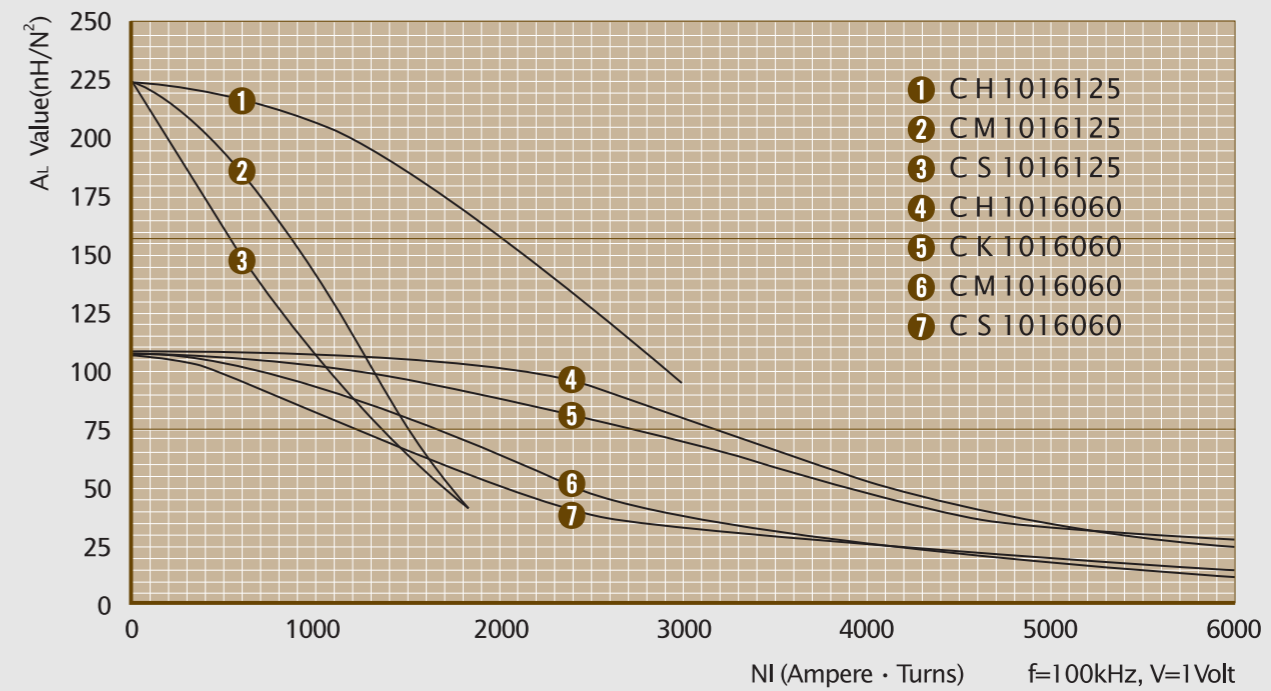

OD 1325

OD 132.5mm / 5.217inches

ID 78.6mm
HT 25.4mm

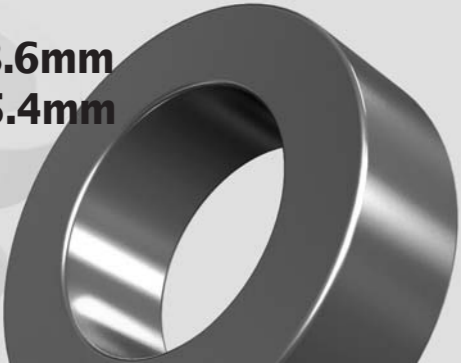

Core Dimensions

		OD(max)	ID(min)	HT(max)
Before coating	(mm)	132.5	78.6	25.4
	(inch)	5.217	3.094	1.000
After coating (Epoxy)	(mm)	134.2	77.0	26.8
	(inch)	5.283	3.032	1.055

Magnetic Dimensions

Cross Section (A)	Path Length (l)	Window Area (Wa)	Volume (V)
6.71cm ²	32.42cm	46.61cm ²	217.58cm ³
1.040in ²	12.77in	9,199,089cmil	13.28in ³

Available Cores

Part No.				A _L	Perm.
MPP	High Flux	Sendust	Mega Flux®	(nH/N ²)	(μ)
CM1325026	CH1325026	CS1325026	CK1325026	68	26
CM1325060	CH1325060	CS1325060	CK1325060	156	60
CM1325125	CH1325125	CS1325125	-	325	125
-	-	-	-	-	147
-	-	-	-	-	160
-	-	-	-	-	173
-	-	-	-	-	200

Winding Information

AWG Wire No.	Single Layer Dia(cm)	Turn Rdc, Q	AWG Wire No.	Single Layer Dia(cm)	Turn Rdc, Q
10	0.267		19	0.0980	
11	0.238		20	0.0879	
12	0.213		21	0.0785	
13	0.190		22	0.0701	
14	0.171	N · A	23	0.0632	N · A
15	0.153		24	0.0566	
16	0.137		25	0.0505	
17	0.122		26	0.0452	
18	0.109		27	0.0409	

Single layer winding with 1 inch leads

■ A_L vs NI Curve (60μ, 125μ)

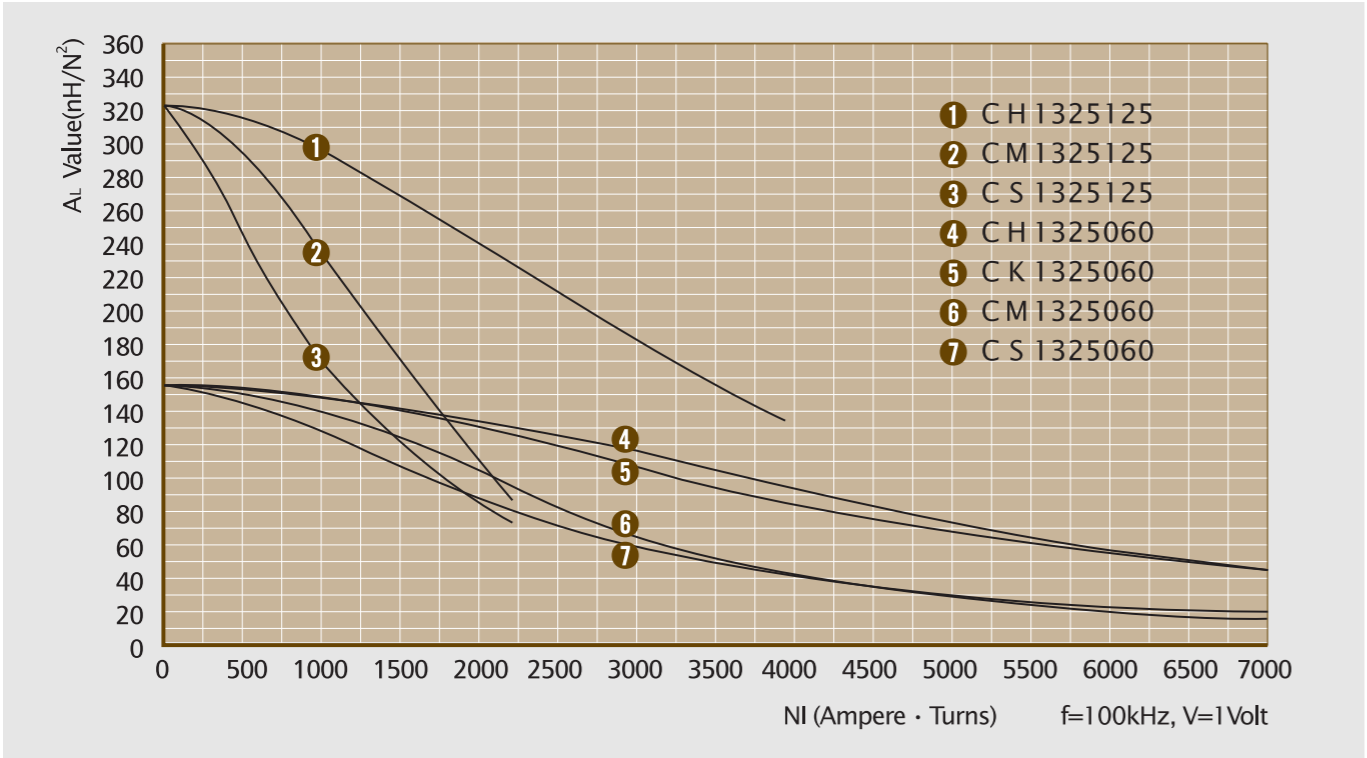

OD 1625

OD 165.0mm / 6.496inches

ID 88.9mm
HT 25.4mm

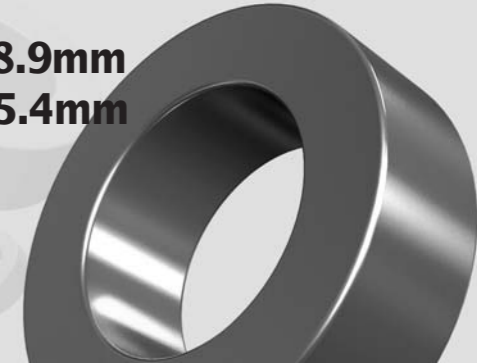

Core Dimensions

		OD(max)	ID(min)	HT(max)
Before coating	(mm)	165.0	88.9	25.4
	(inch)	6.496	3.500	1.000
After coating (Epoxy)	(mm)	167.2	86.9	27.3
	(inch)	6.583	3.421	1.075

Magnetic Dimensions

Cross Section (A)	Path Length (l)	Window Area (Wa)	Volume (V)
9.46cm ²	38.65cm	59.31cm ²	365.63cm ³
1.466in ²	15.22in	11,704,978cmil	22.31in ³

Winding Information

AWG Wire No.	Single Layer Dia(cm)	Turn Rdc, Q	AWG Wire No.	Single Layer Dia(cm)	Turn Rdc, Q
10	0.267		19	0.0980	
11	0.238		20	0.0879	
12	0.213		21	0.0785	
13	0.190		22	0.0701	
14	0.171	N · A	23	0.0632	N · A
15	0.153		24	0.0566	
16	0.137		25	0.0505	
17	0.122		26	0.0452	
18	0.109		27	0.0409	

Single layer winding with 1 inch leads

Available Cores

Part No.				A _L	Perm.
MPP	High Flux	Sendust	Mega Flux®	(nH/N ²)	(μ)
CM1625026	CH1625026	CS1625026	CK1625026	80	26
CM1625060	CH1625060	CS1625060	CK1625060	184	60
CM1625125	CH1625125	CS1625125	-	384	125
-	-	-	-	-	147
-	-	-	-	-	160
-	-	-	-	-	173
-	-	-	-	-	200

■ A_L vs NI Curve (60μ, 125μ)

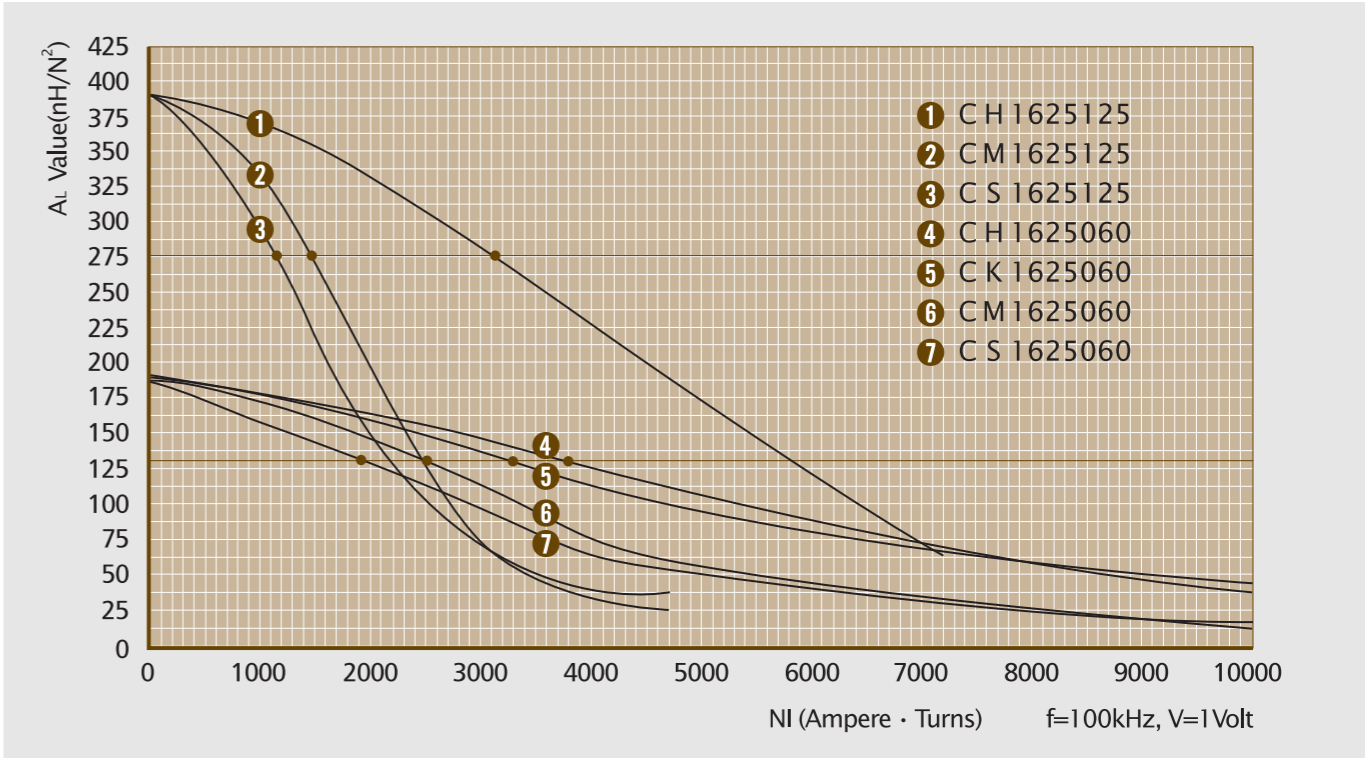

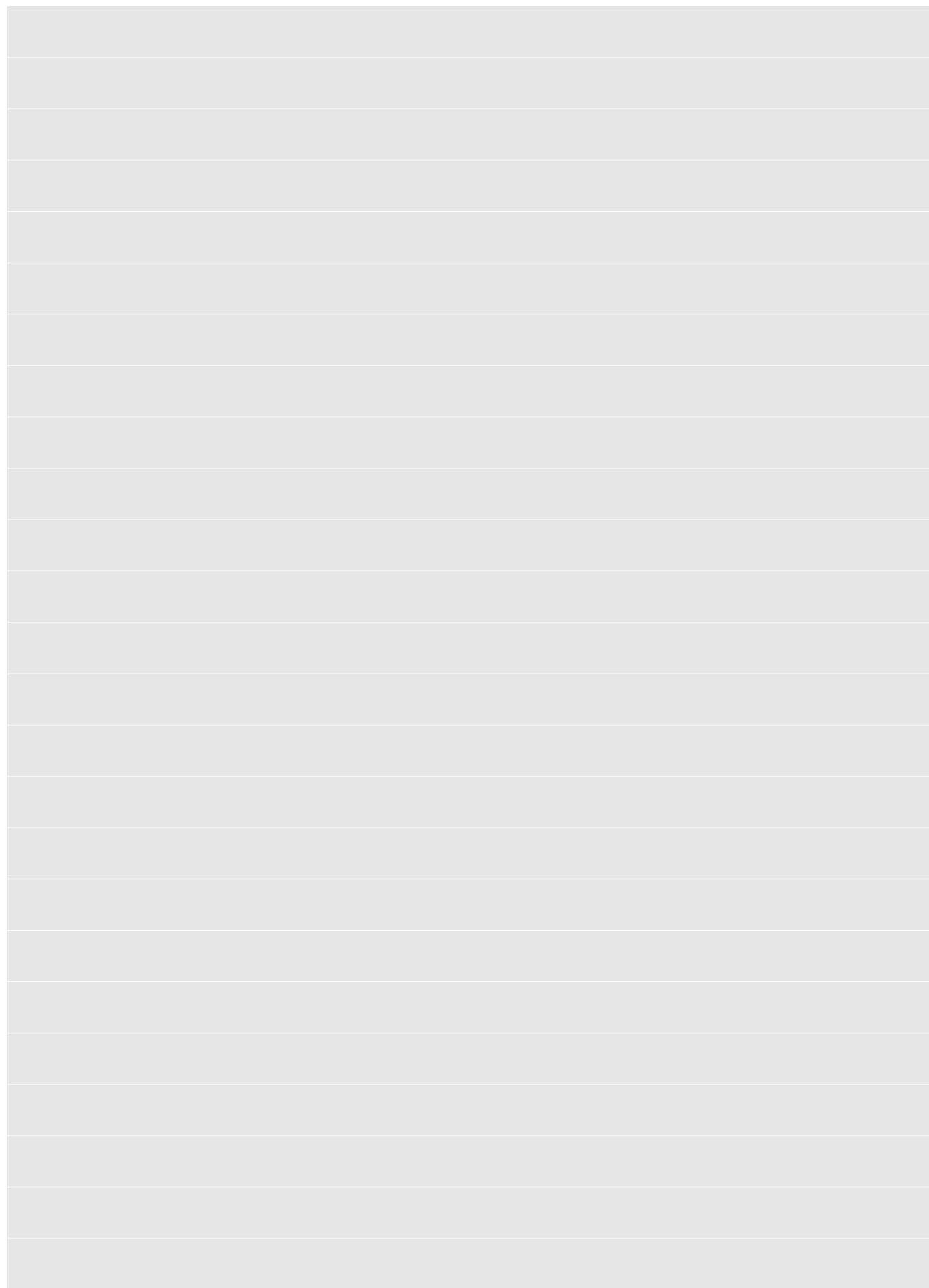

SPECIAL MAGNETIC POWDER CORES

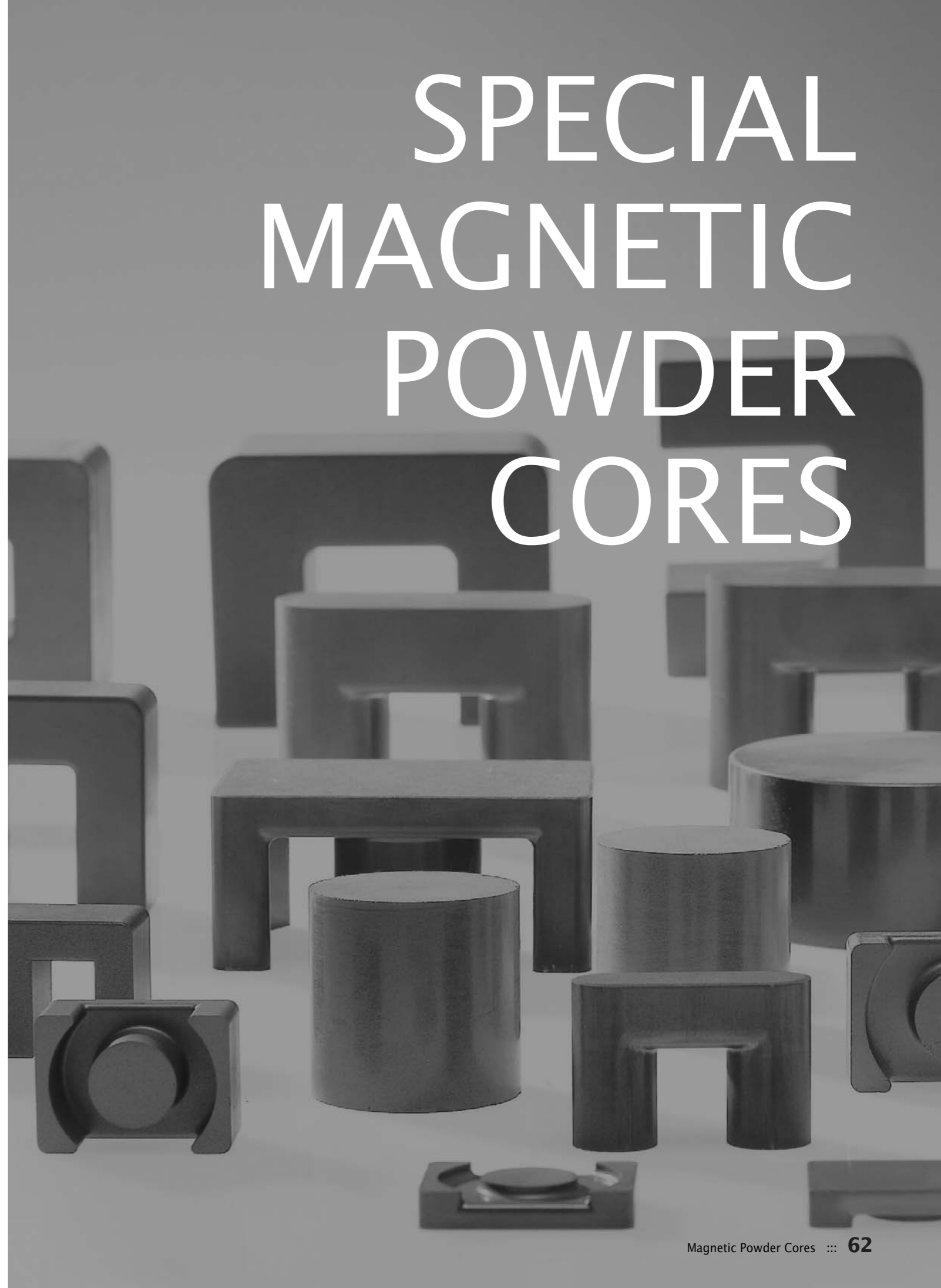

ELLIPSE CORES



Features

- Shorter wire length than rectangular post
- Good DC Bias characteristics
- Larger energy storage capacity
- Low core loss at high frequency

Applications

- Choke filter for solar cell inverters
- Boost Inductor for solar cell inverters



Product Identification

• Post

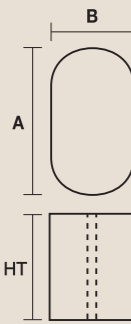

LK 35 15 - 20 C

Permeability : 60 μ	Available perm. 26,40,60 μ
Height : 20mm	Available size : 20mm~25mm
Width : 15mm	
Length : 35mm	
Mega Flux [®] Ellipse Core	LK : Mega Flux [®] , LS: Sendust

• Plate

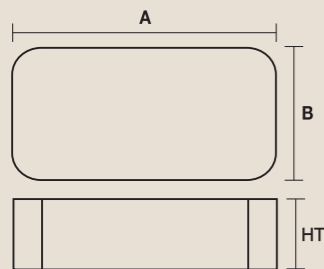

LK 60 35 - 13 C

Permeability : 60 μ	Available perm. 26,40,60 μ
Height : 13mm	Available size : 13mm~18mm
Width : 35mm	
Length : 60mm	
Ellipse Core	LK : Mega Flux [®]

(1) Post Ellipse Cores

Part No.	Dimensions				Cross Section Area (cm ²)
	A Length (mm)	B Width (mm)	RC Radius (mm)	D Height (mm)	
LK3515-20	35	15	7.5	20	4.77
LK3515-25	35	15	7.5	25	4.77
LK3520-20	35	20	7.5	20	6.52
LK3520-25	35	20	7.5	25	6.52

(2) Plate Ellipse Cores

Part No.	Dimensions				Cross Section Area (cm ²)
	A Length (mm)	B Width (mm)	RC Radius (mm)	D Height (mm)	
LK5035-13	50	35	7.5	13.5	4.77
LK5035-18	50	35	7.5	18.5	6.52
LK6035-13	60	35	7.5	13.5	4.77
LK6035-18	60	35	7.5	18.5	6.52
LK7035-13	60	35	7.5	13.5	4.77
LK7035-18	70	35	7.5	18.5	6.52

* LS(Sendust Ellipse Core), LH(High Flux Ellipse Core) and customized designs are also available.

ELLIPSE CORES ASSEMBLY

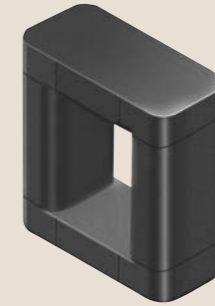

Permeability vs DC Bias Curves

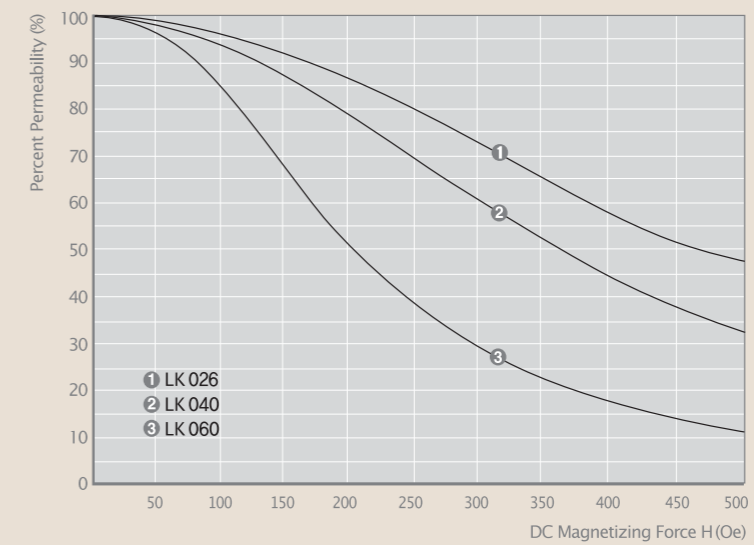

PLATE Part No.	POST		Dimensions					Path Length (cm)	Cross Section Area (cm ²)	Window Area (cm ²)	AL value (nH/N ²) \pm 12%		
	Part No.	1 LEG STACK	A Length (mm)	B Width (mm)	C Height (mm)	D Inner Height (mm)	E Inner Length (mm)				026 μ	040 μ	060 μ
	LK3515-25	2	50	35	77	50	20	18.47	4.77	10	101	130	195
	LK3515-20	3	50	35	87	60	20	16.04	4.77	12	91	117	176
LK5035-18	LK3520-20	2	50	35	77	40	10	18.04	6.52	4	158	204	306
	LK3520-25	2	50	35	87	50	10	20.04	6.52	5	141	182	273
	LK3520-20	3	50	35	97	60	10	22.04	6.52	6	127	164	245
LK6035-13	LK3515-20	2	60	35	67	40	30	18.47	4.77	12	101	130	195
	LK3515-25	2	60	35	77	50	30	20.47	4.77	15	91	117	176
	LK3515-20	3	60	35	87	60	30	22.47	4.77	18	83	107	160
LK6035-18	LK3520-20	2	60	35	77	40	20	18.04	6.52	8	141	182	273
	LK3520-25	2	60	35	87	50	20	20.04	6.52	10	127	164	245
	LK3520-20	3	60	35	97	60	20	22.04	6.52	12	115	149	223
LK7035-13	LK3515-20	2	70	35	67	40	40	20.47	4.77	16	91	117	176
	LK3515-25	2	70	35	77	50	40	22.47	4.77	20	83	107	160
	LK3515-20	3	70	35	87	60	40	24.47	4.77	24	76	98	147
LK7035-18	LK3520-25	2	70	35	77	40	30	20.04	6.52	12	127	164	245
	LK3520-20	2	70	35	87	50	30	22.04	6.52	15	115	149	223
	LK3520-25	3	70	35	97	60	30	24.04	6.52	18	106	136	204

BLOCK CORES



Features

- Large energy storage capacity
- No magnetic flux leakage
- Good temperature stability
- Low core loss at high frequency

Applications

- High inductance choke coils
- Flyback transformers
- Multiple circuit choke coils
- Output chokes for SMPS



Product Identification

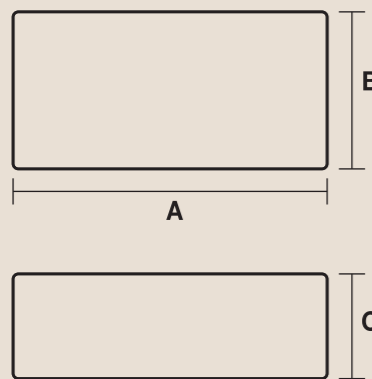

BK 6 3 20 - 060

Permeability : 60μ	Available perm. 26,40,60 μ
Height : 20mm	Available HT : 15mm~20mm
Width : 30mm	
Length : 60mm	Available size : 50mm~80mm
Mega Flux® Block Core	BH : High Flux, BS: Sendust

Part No.	Dimensions (mm)			Cross Section Area(cm ²)
	A	B	C	
BK5315	50.5	30.3	15	4.5
BK5320	50.5	30.3	20	6
BK6315	60.5	30.3	15	4.5
BK6320	60.5	30.3	20	6
BK7315	70.5	30.3	15	4.5
BK7320	70.5	30.3	20	6
BK8315	80.5	30.3	15	4.5
BK8320	80.5	30.3	20	6

※ BS(Sendust Block Core), BH(High Flux Core) and customized designs are also available.

BLOCK CORES ASSEMBLY



Permeability vs DC Bias Curves

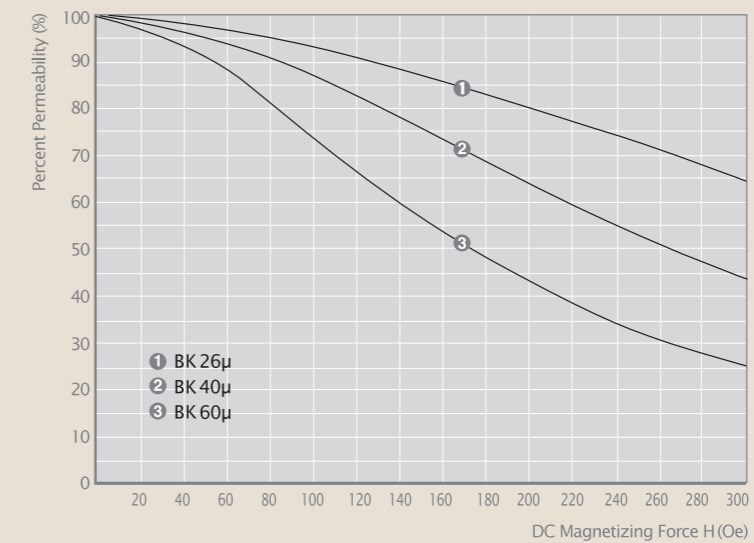

Unit Part No.	Assembled (L x W x H mm)	Path Length (cm)	Window Area (cm ²)	Sectional Area (cm ²)	A _L value (nH/N ²) ± 12%		
					026 μ	040 μ	060 μ
BK5315	80 x 50 x 30	18.71	15	3	95	121	181
BK5320	90 x 50 x 30	18.28	24	3	130	165	247
BK6315	90 x 60 x 30	22.71	18	4.5	79	100	149
BK6320	100 x 60 x 30	22.28	12	6	107	135	203
BK7315	100 x 70 x 30	26.71	28	4.5	67	85	127
BK7320	110 x 70 x 30	26.28	21	6	91	115	172
BK8315	110 x 80 x 30	30.71	40	4.5	58	74	110
BK8320	120 x 80 x 30	30.28	32	6	78	100	149

※ BS(Sendust Block Core), BH(High Flux Block Core) and customized designs are also available.

CYLINDER CORES

SPECIAL MAGNETIC POWDER CORES

SPECIAL MAGNETIC POWDER CORES



Features

- Large energy storage capacity
- Low core loss at high frequency

Applications

- Power inductor for large currents
- Buck/ Boost inductor for inverters



Product Identification

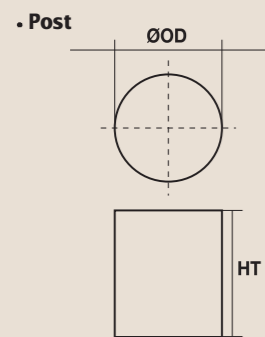

CK 30 30 - 060

Permeability : 60 μ | Available Perm. 26, 40, 60 μ

HT : 30mm

OD : 30mm | Available size 24mm ~ 60mm

Mega Flux[®] Cylinder Core | CS : Sendust, CH : High Flux

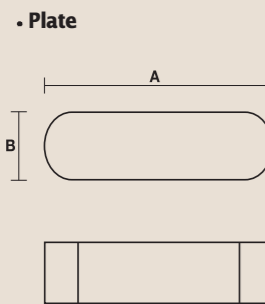

RBK 54 20 - 15 C

Permeability : 60 μ | Available Perm. 26, 40, 60 μ

Height : 15mm | Available size : 13mm~18mm

Width : 20mm

Length : 54mm

Ellipse Core | RBK : Mega Flux[®]

Post Cylinder Cores

Cylinder Part No.	Dimensions		Cross Section Area (cm ²)	Plate
	OD (mm)	HD (mm)		
CK2020	20	20	3.14	RBK5420A
CK2424	24	24	4.52	RBK6424A
CK2525	25	25	4.91	RBK6725A
CK2828	27	27	6.00	RBK7428A
CK3030	30	30	7.07	RBK8030A
CK3035	30	35	7.07	RBK8030A
CK6030	60	30	28.27	-

Plate Cylinder Cores

Plate Part No.	Dimensions				Cross Section Area (cm ²)	Post
	A Length (mm)	B Width (mm)	RC Radius (mm)	D Height (mm)		
RBK5420-15	54	20	10.0	15	3.14	CK2020
RBK6424-18	64	24	12.0	18	4.52	CK2424
RBK6725-19	67	25	12.5	19	4.91	CK2525
RBK7428-21	74	27	13.7	21	6.00	CK2828
RBK8030-23	80	30	15.0	23	7.07	CK3030

CYLINDER ASSEMBLY

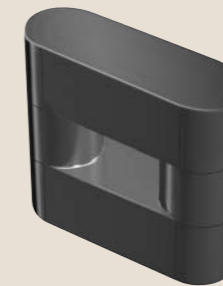

DC Bias Characteristics

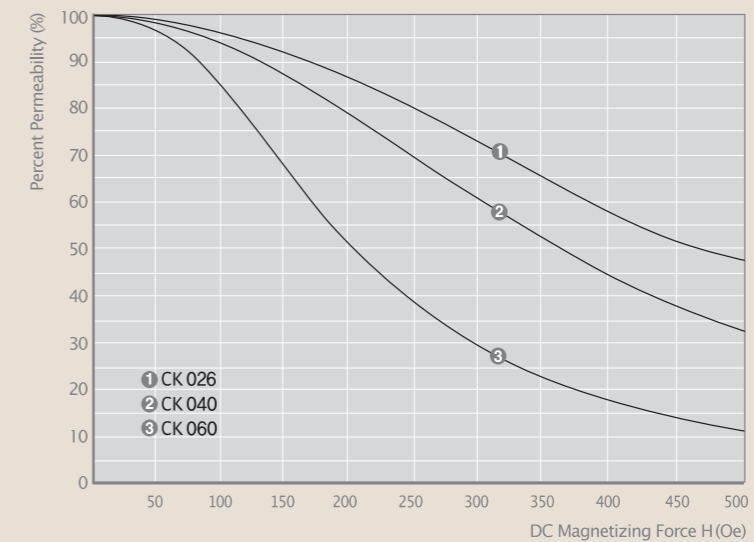
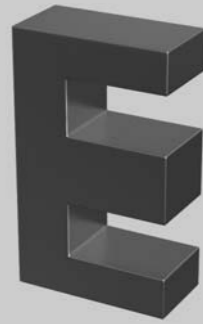

Plate Part No.	Cylinder Part No.	Dimensions						Path Length (cm)	Cross Section Area (cm ²)	Window Area (cm ²)	AL value (nH/N ²) \pm 12%		
		1 LEG STACK	A Length (mm)	B Width (mm)	C Height (mm)	D Inner Height (mm)	E Inner Length (mm)				026 μ	040 μ	060 μ
		RBK5420-15	CK2020	1	54	20	51.4				20	14	12.41
		2	54	20	71.4	40	14	16.41	3.14	5.6	75	96	144
		3	54	20	91.4	60	14	20.41	3.14	8.4	60	77	116
RBK6424-18	CK2424	1	64	24	61.6	24	16	14.72	4.52	3.84	120	154	232
		2	64	24	85.6	48	16	19.52	4.52	7.68	90	116	175
		3	64	24	109.6	72	16	24.32	4.52	11.52	72	93	140
RBK6725-19	CK2525	1	67	25	64.2	25	17	15.41	4.91	4.25	124	160	240
		2	67	25	89.2	50	17	20.41	4.91	8.5	94	121	181
		3	67	25	114.2	75	17	25.41	4.91	12.75	75	97	146
RBK7428-21	CK2828	1	74	27.5	71.4	28	19	17.13	6.00	5.32	136	176	264
		2	74	27.5	99.4	56	19	22.73	6.00	10.64	103	133	199
		3	74	27.5	127.4	84	19	28.33	6.00	15.96	83	106	160
RBK8030-23	CK3030	1	80	30	77	30	20	18.4	7.07	6	150	193	290
		2	80	30	107	60	20	24.4	7.07	12	113	146	218
		3	80	30	137	90	20	30.4	7.07	18	91	117	175

EE CORES

SPECIAL MAGNETIC POWDER CORES



Features

- Large energy storage capacity
- No magnetic flux leakage
- Good temperature stability
- Low core loss at high frequency

Applications

- High inductance choke coils
- Flyback transformers
- Multiple circuit choke coils
- Output chokes for SMPS



Product Identification

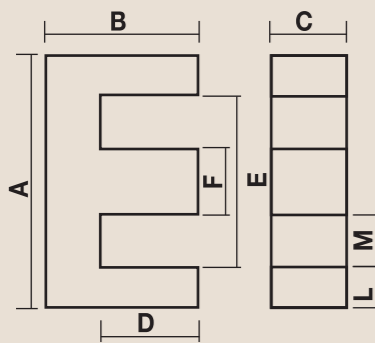

ES 43 21 A - 060

Permeability : 60 μ	Available perm. 26, 40, 60, 90 μ
Height of E core	
Width : 21 mm	Available size : 8.0mm~38.1 mm
Length : 43mm	Available size : 19.0mm~80.0mm
Sendust E core	EK : Mega Flux [®]

Part No.	Dimensions (mm)								Path Length (cm)	Cross Section Area (cm ²)	AL value (nH/N ²) \pm 12%			
	A	B	C	D(min)	E(min)	F	L(nom)	M(min)			026 μ	040 μ	060 μ	090 μ
ES 1908A	19.3	8.1	4.8	5.5	13.9	4.8	2.3	4.7	4.01	0.228	26	35	48	69
ES 2510A	25.1	9.6	6.5	6.2	18.8	6.1	3.0	6.3	4.85	0.385	39	52	70	100
ES 3015A	30.1	15.0	7.1	9.7	19.5	7.0	5.1	6.4	6.56	0.601	33	46	71	92
ES 3515A	34.5	14.1	9.3	9.6	25.3	9.3	4.4	7.9	6.94	0.840	56	75	102	146
ES 4117A	40.9	16.5	12.5	10.4	28.3	12.5	6.0	7.9	7.75	1.520	88	119	163	234
ES 4321A	42.8	21.1	10.8	15.0	30.4	11.7	5.9	9.5	9.84	1.280	56	76	105	151
ES 4321B	42.8	21.1	15.4	15.0	30.4	11.7	5.9	9.5	9.84	1.830	80	108	150	217
ES 4321C	42.8	21.1	20.0	15.0	30.4	11.7	5.9	9.5	9.84	2.370	104	140	194	281
ES 5528A	54.9	27.6	20.6	18.5	37.5	16.8	8.4	10.3	12.30	3.500	116	157	219	
ES 5528B	54.9	27.6	24.6	18.5	37.5	16.8	8.4	10.3	12.30	4.170	138	187	261	
ES 6533A	65.1	32.5	27.0	22.2	44.2	19.7	10.0	12.1	14.70	5.400	162	230	300	
ES 7228A	72.4	27.9	19.0	17.8	52.6	19.1	9.5	16.9	13.70	3.680	130	173	236	
ES 8038A	80.0	38.1	19.8	28.1	59.3	19.8	9.9	19.8	18.50	3.890	103	145	190	

※ EK(Mega Flux[®] EE Core) and customized designs are also available.

EER CORES

SPECIAL MAGNETIC POWDER CORES



Features

- Large energy storage capacity
- No magnetic flux leakage
- Good temperature stability
- Excellent DC bias characteristics

Applications

- Power inductor for large currents
- Multiple circuit choke coils
- Output chokes for SMPS

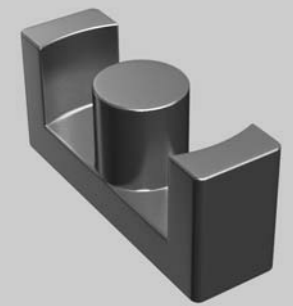

Product Identification

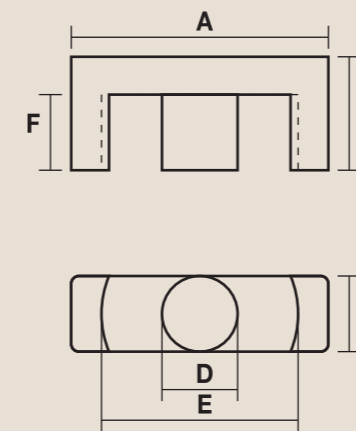

HER 40 13 B - 060

Permeability : 60 μ	Available perm. 26, 40, 60 μ
Height of EER core	
Width : 13mm	Available size : 7mm~17mm
Length : 40mm	Available size : 25mm~49mm
High Flux EER Core	KER : Mega Flux [®] , SER : Sendust

Part No.	Dimensions (mm)						Path Length (cm)	Cross Section Area (cm ²)	AL value (nH/N ²) \pm 12%		
	A	B	C	D	E	F			026 μ	040 μ	060 μ
HER 2507A	25.5	9.3	7.5	7.5	19.8	6.2	5.10	0.450	39	53	73
HER 2507B	25.5	11.0	7.5	7.5	19.8	7.9	5.78	0.450	34	47	65
HER 3010A	30.6	15.8	9.8	9.8	22.0	11	8.66	0.754	38	53	72
HER 3511A	35.0	15.8	11.3	11.3	25.6	9.8	8.30	1.078	57	78	108
HER 3511B	35.0	20.7	11.3	11.3	25.6	14.7	10.27	1.078	46	63	87
HER 4013A	40.0	17.4	13.3	13.3	29.0	10.4	9.13	1.491	72	99	135
HER 4013B	40.0	22.4	13.3	13.3	29.0	15.4	11.13	1.491	59	81	111
HER 4215A	42.0	22.4	15.5	15.5	29.4	15.4	10.64	2.026	84	115	158
HER 4215B	42.0	25.4	15.5	15.5	29.4	18.4	11.84	2.026	75	103	142
HER 4917A	49.0	18.8	17.2	17.2	36.5	12.2	9.57	2.353	99	136	185
HER 4917B	49.0	24.7	17.2	17.2	36.5	18.1	11.93	2.353	79	109	149

※ KER(Mega Flux[®] EER Core), SER(Sendust EER Core) and customized designs are also available.

EQ CORES

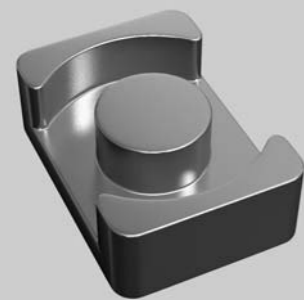

Features

- Small dimensions for large currents
- No magnetic flux leakage
- Excellent DC bias characteristics
- Good temperature stability
- Large energy storage capacity

Applications

- Small dimension DC/DC converters
- Large current choke coils
- Smoothing choke coils
- CPU cores for lap-top computers



Product Identification

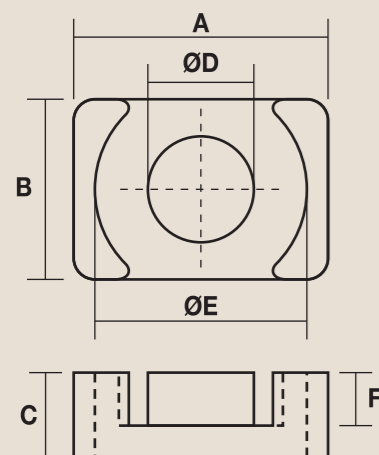

KEQ 41 28 A - 040

Permeability : 40 μ	Available perm. 26, 40, 60 μ
Height of EQ core	
Width : 28mm	
Length : 40mm	Available size : 21mm~65mm
Mega Flux® EQ core	HEQ : High Flux, SEQ : Sendust

Part No.	Dimensions (mm)						Path Length (cm)	Cross Section Area (cm ²)	A _L value (nH/N ²) ±12%		
	A	B	C	D	E	F			026 μ	040 μ	060 μ
KEQ 2014A	20.5	14.0	8.1	8.8	18.0	5.7	4.52	0.608	44	68	101
KEQ 2014B	20.5	14.0	10.1	8.8	18.0	7.7	5.32	0.608	37	57	86
KEQ 2619A	26.5	19.0	10.1	12.0	22.6	6.8	5.47	1.198	72	110	165
KEQ 2619B	26.5	19.0	12.4	12.0	22.6	9.1	6.39	1.198	61	94	141
KEQ 3222A	32.0	22.0	10.3	13.5	27.6	6.6	6.03	1.523	83	127	190
KEQ 3222B	32.0	22.0	15.2	13.5	27.6	11.5	7.99	1.523	62	96	144
KEQ 3626A	36.0	26.0	17.4	14.4	32.0	13.4	9.47	1.808	62	96	144
KEQ 4128A	41.5	28.0	19.9	14.9	36.5	15.4	11.52	1.997	57	87	131
KEQ 5032A	50.0	32.0	25.0	20.0	44.0	19.5	13.34	3.141	77	118	178
KEQ 6542A	65.0	42.0	30.0	26.0	57.2	22.8	16.53	5.309	105	161	242

※ HEQ(High Flux EQ Core), SEQ(Sendust EQ core) and customized designs are also available.

ER CORES



Features

- Small dimensions for large currents
- No magnetic flux leakage
- Excellent DC bias characteristics
- Good temperature stability
- Large energy storage capacity

Applications

- Small dimension DC/DC converters
- Large current choke coils
- Smoothing choke coils
- CPU cores for lap-top computers

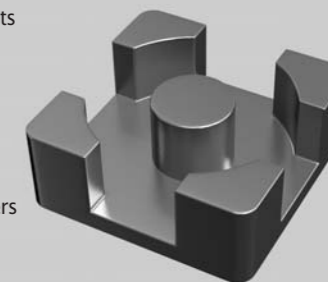

Product Identification

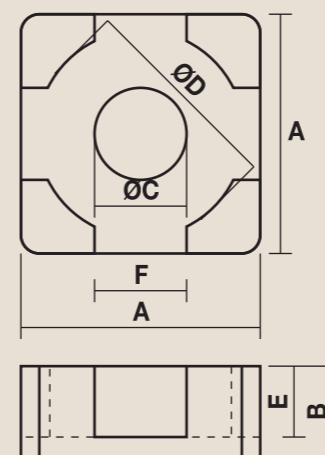

RH 12 44 SC

Shape Number	
Height : 4.4mm	
Length : 12mm	Available size 8mm ~15mm
High Flux ER core	RK : Mega Flux®

Part No.	Dimensions (mm)						Path Length (cm)	Cross Section Area (cm ²)	A _L value (nH/N ²) ±15%
	A	B	C	D	E	F			
RH0721SC	7.6	2.1	2.88	6.5	1.15	2.82	1.39	0.117	37.1
RH0725SC	7.6	2.5	2.88	6.5	1.55	2.82	1.55	0.117	33.3
RH1028SC	10.1	2.8	3.85	8.65	1.75	3.76	1.73	0.206	52.3
RH1034SC	10.1	3.4	3.85	8.65	2.35	3.76	1.97	0.206	45.9
RH1237SC	12.7	3.7	4.85	10.8	2.45	4.7	2.19	0.329	66.1
RH1244SC	12.7	4.4	4.85	10.8	3.15	4.7	2.47	0.329	58.6
RH1539SC	15.2	3.9	5.76	12.96	2.35	5.64	2.45	0.468	83.9
RH1549SC	15.2	4.9	5.76	12.96	3.35	5.64	2.85	0.468	72.1

※ RK(Mega Flux®RK core) and customized designs are also available.

U CORES



Features

- Large energy storage capacity
- No magnetic flux leakage
- Good temperature stability
- Low core loss at high frequencies

Applications

- High inductance choke coils
- Flyback transformers
- Multiple circuit choke coils
- Output chokes for SMPS



Product Identification

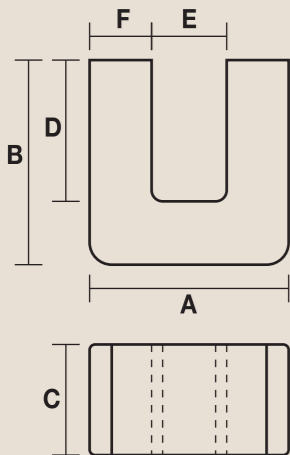

UK 41 41 C-060

Permeability : 60μ	Available perm. 26, 40, 60 μ
Height of U core	
Width : 41 mm	Available size : 36mm~ 65mm
Length : 41 mm	Available size : 35mm~ 79mm
Mega Flux® U core	UH : High Flux, US : Sendust

Part No.	Dimensions (mm)						Path Length (cm)	Cross Section Area(cm ²)	A _L value (nH/N ²) ± 12%		
	A	B	C	D	E	F			026 μ	040 μ	060 μ
UK3536A	35.0	36.0	20.0	25.0	13.0	11.0	16.90	2.200	43	65	98
UK3536B	35.0	36.0	25.0	25.0	13.0	11.0	16.90	2.750	53	82	123
UK4141A	41.0	41.0	20.0	28.0	15.0	13.0	19.30	2.600	44	68	102
UK4141B	41.0	41.0	25.0	28.0	15.0	13.0	19.30	3.250	55	85	127
UK4141C	41.0	41.0	30.0	28.0	15.0	13.0	19.30	3.900	66	102	152
UK5251A	52.0	51.0	25.0	35.0	20.0	16.0	24.30	4.000	54	83	124
UK5251B	52.0	51.0	30.0	35.0	20.0	16.0	24.30	4.800	65	99	149
UK6361A	63.0	60.5	30.0	41.5	25.0	19.0	29.10	5.700	64	98	148
UK6361B	63.0	60.5	35.0	41.5	25.0	19.0	29.10	6.650	75	115	172
UK7965A	79.0	64.5	30.0	42.5	35.0	22.0	32.60	6.600	66	102	153
UK7965B	79.0	64.5	35.0	42.5	35.0	22.0	32.60	7.700	77	119	178

※ UH(High Flux U Core), US(Sendust U Core) and customized designs are also available.

WASHER CORES

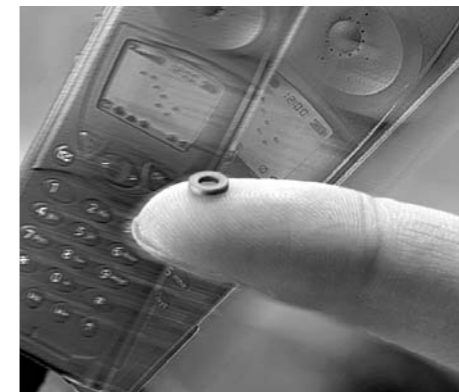

Features

- High permeability powder cores
- Low core loss at high frequencies
- High efficiency washer cores
- Minimum magnetic flux leakage
- Excellent DC bias characteristics
- Good temperature stability
- Large energy storage capacity

Applications

- Choke coil for mobile phones
- Inductor for handheld devices
- Power Inductor for PDA, LCD



Product Identification

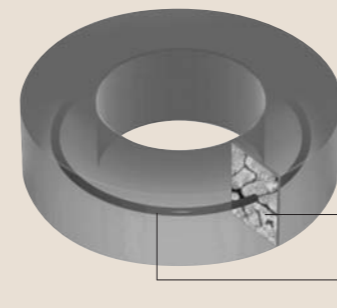

DM 46 12 P

Parylene - C coated	
Height : 1.2mm	Available HT 0.8mm~ 1.2mm
OD size : 4.6mm	Available size : 3.5mm~ 6.3mm
Washer Core	DM : Washer MPP Core

Part No.	Core Dimensions (mm) Before Finish			A _L value (nH/N ²) ± 12%	Path Length (cm)	Typical Inductance L@ 0A, 20T (μH)	Recommended Inductance L (μH) at 0A
	OD	ID	HT				
DM 3508P	3.56	1.78	0.8	14	0.817	5.6	3.3, 4.7, 6.8, 10
DM 3510P			1.0	17		6.8	
DM 3908P	3.94	2.24	0.8	11	0.942	4.4	3.3, 4.7, 6.8, 10, 15, 22
DM 3910P			1.0	14		5.6	
DM 3912P			1.2	17		6.8	
DM 4610P	4.65	2.36	1.0	16	1.060	6.4	3.3, 4.7, 6.8, 10, 15, 22
DM 4612P			1.2	20		8	
DM 4614P			1.4	22		8.8	
DM 6310P	6.35	3.79	1.0	18	1.361	8.8	4.7, 6.8, 10, 15, 22, 33, 47, 56
DM 6312P			1.2	22		8.8	

BIG TOROIDAL CORES

SPECIAL MAGNETIC POWDER CORE



Features

- Excellent DC bias characteristics
- Near zero magnetostriction coefficient constant
- Good temperature stability

Applications

- Power factor correction(PFC) circuits
- Power inductors for large currents
- AC Reactors for inverters



Product Identification

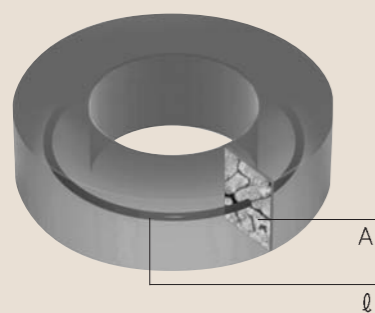

CS 16 25 026 E

- Epoxy coated** | E : Epoxy, C : Plastic case, U : uncoated
- Perm. : 26μ** | Available perm. 26, 50, 60, 125μ
- Height : 25mm** | Available HT 13.6mm~ 40.6mm
- OD size : 165mm** | Available size : 101.6mm~ 165.0mm
- Sendust Core** | CM : MPP, CH : High Flux, CK : Mega Flux®

CSC' big toroidal cores produced by a 3000 ton press are ideal for high current applications, especially in UPS, renewable energy(solar/wind), high power industrial power systems. The maximum diameter is 165mm(6.5")OD and the electrical characteristics are the same as small toroidal cores. CSC cores are the world's biggest and strongest on the market today.

Part No.	Before Finish Dimensions (mm)			After Finish Dimensions (mm)			Weight (g)	Path Length (cm)	Cross Section Area (cm ²)	AL value (nH/N ²) ±8%		
	OD(mm) Max	ID(mm) Min	HT(mm) Max	OD(mm) Max	ID(mm) Max	HT(mm) Max				026μ	060μ	125μ
CS1013	101.6	57.2	13.6	103.1	55.7	14.9	548.6	24.27	2.972	40	92	192
CS1016	101.6	57.2	16.5	103.1	55.7	17.8	665.6	24.27	3.522	47	112	228
CS1027	101.6	57.2	27.2	103.1	55.7	28.5	1097.3	24.27	5.944	80	184	384
CS1033	101.6	57.2	33.0	103.1	55.7	34.3	1331.3	24.27	7.044	94	224	456
CS1320	132.5	78.6	20.3	134.2	77	21.7	1280.1	32.42	5.347	54	124	259
CS1325	132.5	78.6	25.4	134.2	77	26.8	1601.7	32.42	6.710	68	156	325
CS1333	132.5	78.6	33.0	134.2	77	34.4	2080.9	32.42	8.717	88	202	422
CS1340	132.5	78.6	40.6	134.2	77	42	2560.2	32.42	10.694	108	248	518
CS1650	165.0	88.9	25.4	167.2	86.9	27.3	2808.0	38.65	9.460	80	184	384

※ CM(MPP core), CH(High Flux core), CK(Mega Flux® core) and customer specifications are also available.

Terminology

AL Value (nH/N²)

The inductance (nanohenries) of a core for 1 turn winding. It is measured at peak AC flux density of 10 gauss and frequency of 10kHz. $1\text{ nH/N}^2 = 1\text{ mH}/(1000\text{ turns})^2$

Ambient Temperature

Temperature surrounding the devices or circuits. The ambient temperature is measured at 0.5inch(1.27cm) away from the devices or circuits.

Attenuation

The ratio of output parameter (voltage, current, power, etc.) to input parameter. Unit is [dB]. In the case of power, dB is $10\log(\text{output power} / \text{input power})$. In the case of current and voltage, dB is $20\log(\text{output current} / \text{input current})$, $20\log(\text{output voltage} / \text{input voltage})$ respectively.

Coercive Force (H_c)

Refer to Hysteresis Curve.

Common-Mode Noise

Electrical interference that is common to both lines in relation to the ground.

Copper Loss [watts]

The power loss (I^2R) or heat generated by current (I) flowing in a winding with resistance (R).

Core loss [watts]

Core loss is composed of eddy current loss, hysteresis loss and residual loss. Refer to Magnetic Design Formulae.

Cross Sectional Area (A)

The effective cross sectional area of a core available for magnetic flux. The cross sectional area listed for toroidal cores is based on bare core dimensions.

Curie Temperature, T_c [°C]

The transition temperature above which a core loses its ferromagnetic properties. Usually defined as the temperature at which μ falls to 10% of its room temperature value.

DC Resistance [Ω]

Resistance of winding when AC current is not applied.

Differential Mode Noise

Electrical interference that is not common to both lines but is present between both lines. This is also known as normal mode noise.

Disaccommodation

The proportional change of permeability after a disturbance of a magnetic material. It is measured at a constant temperature over a given time interval.

Distributed Capacitance

In an inductor, each winding behaves as a capacitor having the distributed capacitance. Distributed capacitance is parallel with

inductance in the circuit and causes self-resonance at a certain frequency. An inductor which has a smaller distributed capacitance extends a much higher self resonant frequency. So the inductor should be wound to have as small a distributed capacitance as possible.

Eddy Current

When a varying electric or magnetic field passes through the conducting material, current which opposes the change of field is induced in it. This current is called eddy current. Because a conducting material has electric resistance, the eddy current results in heat loss. This is referred to as the eddy current loss.

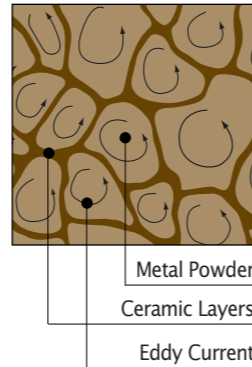

Figure 1. Eddy Current in Powder Cores

Effective Permeability (μ_e)

Refer to Permeability.

EMI

The acronym for Electromagnetic Interference is EMI. Generally, EMI refers to unnecessary electrical energies such as noise.

EMC

Electromagnetic Compatibility

Hysteresis Curve (B-H Loop)

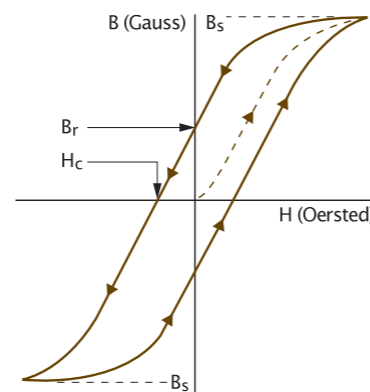

Figure 2. B-H Loop

When the magnetic material is taken through a complete cycle of magnetization and demagnetization, the magnetic flux density in that material behaves irreversibly according to the change of the magnetizing force.

The results are as shown in Figure 2. As H is increased in the neutral magnetic material, flux density B increases along the dashed line (initial magnetization curve) to the saturation point, B_s.

When H is now decreased, the B-H loop transverses a path to B_r (remanent flux density), where H is zero and the core is still magnetized. The magnetizing force H is now reversed to give a negative value. The magnetizing force required to reduce the flux B_r to zero is called the coercive force (H_c). Along the initial magnetization curve, B increases from the origin nonlinearly with H until the material saturates. In practice, the magnetization of a core in an excited inductor never follows this curve because the core is never in a totally demagnetized state when the magnetizing force is first applied.

Flux Density, Magnetic Induction, B [Gauss ; Tesla]

The corresponding parameter for the induced magnetic field in an area perpendicular to the flux path. Flux density is determined by the field strength and permeability of the medium in which it is measured. $1\text{ T}=10^4\text{ Gauss}$

Incremental Permeability (Δμ)

Refer to Permeability.

Inductor

A passive device that prevents a variance of the current. Magnetic flux is induced in the inductor when current flows through the inductor, and the voltage induced by magnetic flux prevents the change of current. Induced voltage

$$\xi = L \cdot di/dt.$$

Initial Permeability (μ_i)

Refer to Permeability.

Leakage Flux

Leakage flux is the small fraction of the total magnetic flux in a transformer or common mode choke that does not contribute to the magnetic coupling of the windings of the device. The presence of leakage flux in a transformer or common mode choke is modeled as a small "leakage" inductance in series with each winding. In a multi-winding choke or transformer, leakage inductance is the inductance measured at one winding with all other windings short circuited.

Litz Wire

A wire made by twisting and bundling some insulated wire. It can decrease the copper loss at high frequency by reducing the skin effect.

Magnetic Hysteresis

Refer to Hysteresis Loop.

Magnetizing Force, H [Oe ; A/m]

The magnetic field strength which produces magnetic flux. The mmf per unit length. H can be considered to be a measure of the strength or effort that the magnetomotive force applies to magnetic circuit to establish a magnetic field. H may be expressed as $H=Nl/\ell$, where ℓ is the mean length of the magnetic circuit in meters. $1\text{ oersted}=79.58\text{ A/m}$

Mean Magnetic Path Length (ℓ)

The effective magnetic path length of a core structure (cm). Refer to Magnetic Design Formulae.

Terminology

Normal Mode Noise

Refer to Differential Mode Noise.

Noise

Unnecessary electrical energy that rises in a circuit.

Operating Temperature Range

The temperature at which a device can be operated normally. Above this temperature, the characteristics of the device can become inferior or the device may operate abnormally. In the case of the inductor, this temperature refers to the temperature rise by the copper loss or core loss. Refer to temperature rise.

Permeability (μ)

In magnetics, permeability is the ability of a material to conduct flux. The magnitude of the permeability at a given induction is a measure of the ease with which a core material can be magnetized to that induction. It is defined as the ratio of the flux density B to the magnetizing force H.

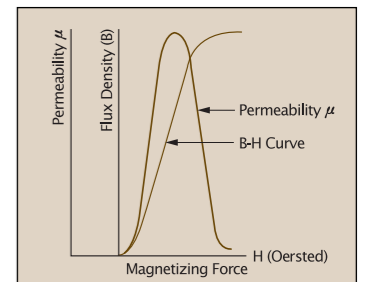

Figure 3. Variation of μ along the Magnetization Curve

$$\text{Permeability} : \mu = B/H [\text{Gauss/Oersted}]$$

The slope of the initial magnetization curve at any given point gives the permeability at that point. Permeability can be plotted against a typical B-H curve as shown in Figure 3 permeability is not constant, therefore its value can be stated only at a given value of B or H. There are many different kinds of permeability.

Absolute Permeability (μ₀)

Permeability in a vacuum

Initial Permeability (μ_i)

Slope of the initial magnetization curve at the origin, that is, the value of permeability at a peak AC flux density of 10 gauss (1 millitesla).

$$\mu = B/H \text{ (Figure 4)}$$

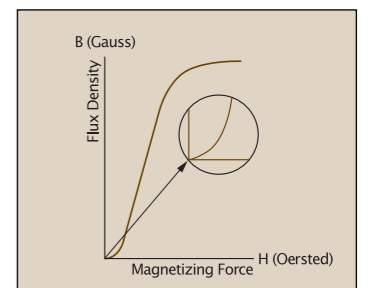

Figure 4. Initial Permeability

Incremental Permeability (Δμ)

The slope of the magnetization curve for finite values of peak-to-peak flux density with superimposed DC magnetization (Figure 5). Initial permeability can be thought of as incremental permeability with 0 DC magnetization at small inductions. The incremental permeability is expressed as the slope of the B-H characteristic at around the given operating point.

Terminology

$$\Delta\mu = \frac{\Delta B}{\Delta H}$$

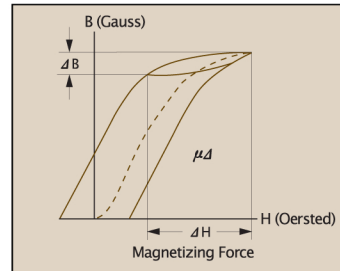

Figure 5. Incremental Permeability

Effective Permeability (μ_e)

If a magnetic circuit is not homogeneous (i.e. contains an air gap), the effective permeability is the permeability of a hypothetical homogeneous (ungapped) structure of the same shape, dimensions, and reluctance that would give the inductance equivalent to the gapped structure.

Relative Permeability (μ_r)

Permeability of a material relative to that of free space.

Maximum permeability (μ_{max})

The slope of a straight line drawn from the origin tangent to the curve at its knee. (Figure 6)

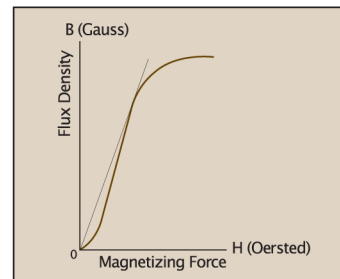

Figure 6. Maximum Permeability

Rated Current

Continuous DC current that can flow in the inductor. It is determined by the maximum temperature rise at the maximum storage temperature range. As rated current is related to power loss of the inductor, DC resistance of the inductor should be lowered or the inductor size should be increased in order to increase the rated current.

Saturation Current

The current at which the inductance decreases below a critical percent inductance (10% or 20% of the initial inductance) by applying DC current to an inductor. In general the critical percent inductance is 10% for ferrite cores and 20% for metal powder cores. The decrease of inductance is caused by the magnetic characteristics of cores. Cores can store a certain amount of flux density, but above that flux density the permeability and inductance of the cores decrease.

Self Resonant Frequency, SRF

The frequency at which the resonance appears between distributed capacitance and inductance of an inductor. At this frequency, inductance and capacitance are canceled out and the inductor is almost a resistor having high impedance. Distributed capacitance that

arises between wires and between wires and cores is parallel with inductance in circuits. Above the self resonant frequency, the capacitive reactance is dominant and the inductor works like the capacitor.

Skin Effect

As the frequency is higher, the current flow is limited to the surface of the wire because the magnetic field in the center of the wire increases. The depth from the wire surface at which the current density at the wire surface decreases by 1/e (37%) is called "skin depth", and this is determined by the conductivity of the wire. As the frequency is higher, skin depth decreases, the reactance of wire increases and current flow is interfered. Litz wire may be used in order to decrease the skin effect.

Storage Temperature Range

Temperature range in which the characteristics of a device can be preserved.

Remanence, Br [Gauss ; Tesla] Refer to Hysteresis Curve.

Saturation

The point at which the flux density B in a magnetic material does not increase with further applications of greater magnetization force H. At saturation, the slope of a material's B-H characteristic curve becomes extremely small, with the instantaneous permeability approaching that of free space. (relative permeability = 1.0)

Saturation Flux Density, Bs [Gauss ; Tesla]

The maximum intrinsic induction possible in a material. This is the flux level at which additional H-field produces no additional B-field.

Temperature Rise (ΔT)

The increase in surface temperature of a component in free-standing air due to the total power dissipation (both copper and core loss). Approximate temperature rise is as follows ;

$$\Delta T(^{\circ}\text{C}) = \left[\frac{\text{Total Power Dissipation (Milliwatts)}}{\text{Surface Area (cm}^2\text{)}} \right]^{0.833}$$

Total Power Dissipation = Copper Losses + Core Losses



Innovative Technological Advancements

Special Shaped Magnetic Powder Cores

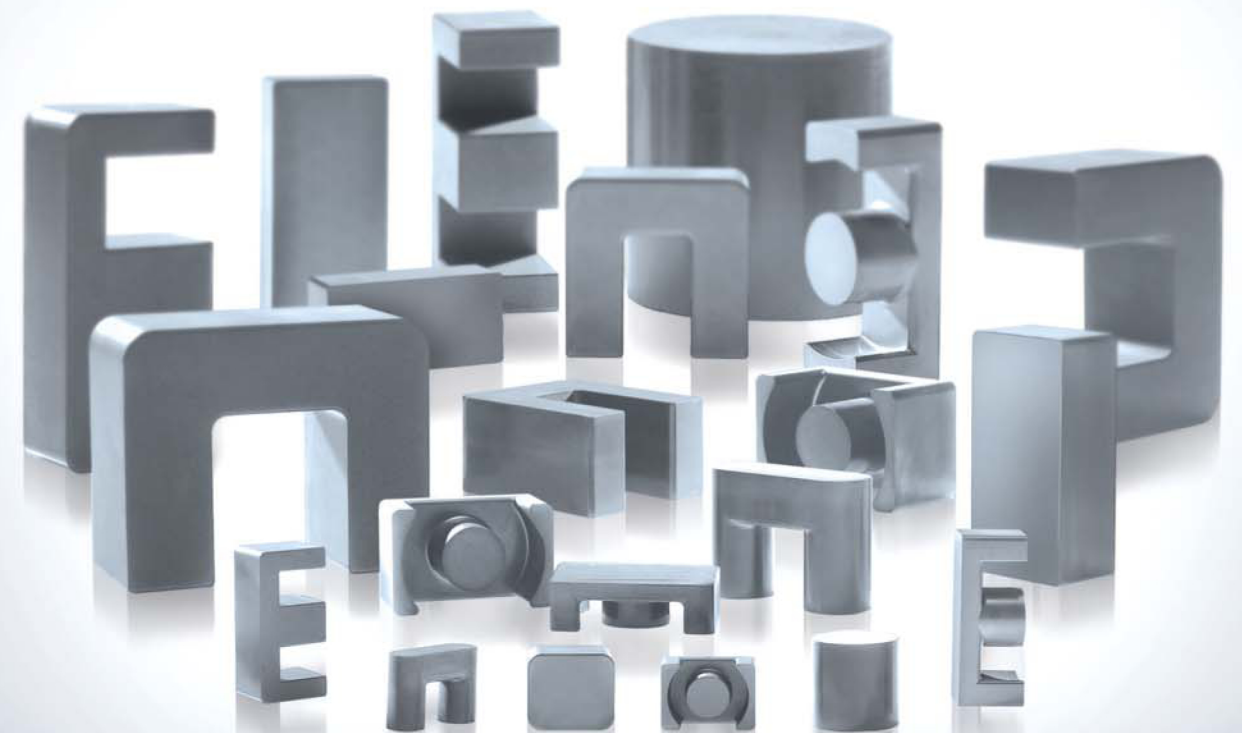

Research & Development

Chang Sung Corporation has become a global leader through its outstanding R&D center, which is constantly striving to develop new technologies and products. In particular, CSC magnetic powder cores have raised the company's profile and competitiveness in the world market.

The CSC product line is constantly evolving and improving through our highly advanced R&D center equipped with the most modern research facilities.



AC Power Supply

▼ EQUIPMENT

- B-H Analyser
- B-H Loop Tracer
- DC Bias Tracer
- Precision LCR Meter
- AC Power Supply
- Electrical Load
- Oscilloscope
- Puncture Tester
- Vibrating Sample Magnetometer (VSM)
- PFC Test Kit
- Impedance Analyser
- Scanning Electron Microscope (SEM)
- Optical Microscope
- Laser Particle Size Analyser
- Specific Surface Area Analyser (BET)
- Oxygen / Nitrogen Analyser
- Atomic Absorption Spectrophotometer
- Heat Treating Furnaces
- Optical Emission Spectrometer
- Electrolysis Analyser
- Thermal Analysis Equipment (DSC, TG, DTA)
- Constant Temperature & Humidity Chamber
- Universal Testing Machine (UTM)
- Hardness Testers, etc.



VSM



SEM



BET



B-H LOOP



Anechoic Chamber



LCR

